THE VIRGINIA REGISTER INFORMATION PAGE

THE VIRGINIA REGISTER is an official state publication issued every other week throughout the year. Indexes are published quarterly, and the last index of the year is cumulative. **THE VIRGINIA REGISTER** has several functions. The new and amended sections of regulations, both as proposed and as finally adopted, are required by law to be published in **THE VIRGINIA REGISTER OF REGULATIONS**. In addition, **THE VIRGINIA REGISTER** is a source of other information about state government, including all emergency regulations and executive orders issued by the Governor, the Virginia Tax Bulletin issued periodically by the Department of Taxation, and notices of public hearings and open meetings of state agencies.

ADOPTION, AMENDMENT, AND REPEAL OF REGULATIONS

An agency wishing to adopt, amend, or repeal regulations must first publish in the *Virginia Register* a notice of intended regulatory action; a basis, purpose, substance and issues statement; an economic impact analysis prepared by the Department of Planning and Budget; the agency's response to the economic impact analysis; a summary; a notice giving the public an opportunity to comment on the proposal; and the text of the proposed regulation.

Following publication of the proposal in the *Virginia Register*, the promulgating agency receives public comments for a minimum of 60 days. The Governor reviews the proposed regulation to determine if it is necessary to protect the public health, safety and welfare, and if it is clearly written and easily understandable. If the Governor chooses to comment on the proposed regulation, his comments must be transmitted to the agency and the Registrar no later than 15 days following the completion of the 60-day public comment period. The Governor's comments, if any, will be published in the *Virginia Register*. Not less than 15 days following the completion of the 60-day public comment period, the agency may adopt the proposed regulation.

The appropriate standing committee of each branch of the General Assembly may meet during the promulgation or final adoption process and file an objection with the Registrar and the promulgating agency. The objection will be published in the *Virginia Register*. Within 21 days after receipt by the agency of a legislative objection, the agency shall file a response with the Registrar, the objecting legislative committee, and the Governor.

When final action is taken, the agency again publishes the text of the regulation as adopted, highlighting all changes made to the proposed regulation and explaining any substantial changes made since publication of the proposal. A 30-day final adoption period begins upon final publication in the *Virginia Register*.

The Governor may review the final regulation during this time and, if he objects, forward his objection to the Registrar and the agency. In addition to or in lieu of filing a formal objection, the Governor may suspend the effective date of a portion or all of a regulation until the end of the next regular General Assembly session by issuing a directive signed by a majority of the members of the appropriate standing committees and the Governor. The Governor's objection or suspension of the regulation, or both, will be published in the *Virginia Register*. If the Governor finds that changes made to the proposed regulation have substantial impact, he may require the agency to provide an additional 30-day public comment period on the changes. Notice of the additional public comment period required by the Governor will be published in the *Virginia Register*.

The agency shall suspend the regulatory process for 30 days when it receives requests from 25 or more individuals to solicit additional public comment, unless the agency determines that the changes have minor or inconsequential impact.

A regulation becomes effective at the conclusion of the 30-day final adoption period, or at any other later date specified by the promulgating agency, unless (i) a legislative objection has been filed, in which event the regulation, unless withdrawn, becomes effective on the date specified, which shall be after the expiration of the 21-day extension

period; (ii) the Governor exercises his authority to require the agency to provide for additional public comment, in which event the regulation, unless withdrawn, becomes effective on the date specified, which shall be after the expiration of the period for which the Governor has provided for additional public comment; (iii) the Governor and the General Assembly exercise their authority to suspend the effective date of a regulation until the end of the next regular legislative session; or (iv) the agency suspends the regulatory process, in which event the regulation, unless withdrawn, becomes effective on the date specified, which shall be after the expiration of the 30-day public comment period.

Proposed regulatory action may be withdrawn by the promulgating agency at any time before the regulation becomes final.

EMERGENCY REGULATIONS

If an agency demonstrates that (i) there is an immediate threat to the public's health or safety; or (ii) Virginia statutory law, the appropriation act, federal law, or federal regulation requires a regulation to take effect no later than (a) 280 days from the enactment in the case of Virginia or federal law or the appropriation act, or (b) 280 days from the effective date of a federal regulation, it then requests the Governor's approval to adopt an emergency regulation. The emergency regulation becomes operative upon its adoption and filing with the Registrar of Regulations, unless a later date is specified. Emergency regulations are limited to addressing specifically defined situations and may not exceed 12 months in duration. Emergency regulations are published as soon as possible in the *Register*.

During the time the emergency status is in effect, the agency may proceed with the adoption of permanent regulations through the usual procedures. To begin promulgating the replacement regulation, the agency must (i) file the Notice of Intended Regulatory Action with the Registrar within 60 days of the effective date of the emergency regulation; and (ii) file the proposed regulation with the Registrar within 180 days of the effective date of the emergency regulation. If the agency chooses not to adopt the regulations, the emergency status ends when the prescribed time limit expires.

STATEMENT

The foregoing constitutes a generalized statement of the procedures to be followed. For specific statutory language, it is suggested that Article 2 (§ 9-6.14:7.1 et seq.) of Chapter 1.1:1 of the Code of Virginia be examined carefully.

CITATION TO THE VIRGINIA REGISTER

The *Virginia Register* is cited by volume, issue, page number, and date. **12:8 VA.R. 1096-1106 January 8, 1996**, refers to Volume 12, Issue 8, pages 1096 through 1106 of the *Virginia Register* issued on January 8, 1996.

"THE VIRGINIA REGISTER OF REGULATIONS" (USPS-001831) is published bi-weekly, with quarterly cumulative indices published in January, April, July and October, for \$100 per year by the Virginia Code Commission, General Assembly Building, Capitol Square, Richmond, Virginia 23219. Telephone (804) 786-3591. Periodical Postage Rates Paid at Richmond, Virginia. **POSTMASTER:** Send address changes to **THE VIRGINIA REGISTER OF REGULATIONS, 910 CAPITOL STREET, 2ND FLOOR, RICHMOND, VIRGINIA 23219.**

The Virginia Register of Regulations is published pursuant to Article 7 (§ 9-6.14:22 et seq.) of Chapter 1.1:1 of Title 9 of the Code of Virginia. Individual copies, if available, may be purchased for \$4.00 each from the Registrar of Regulations.

Members of the Virginia Code Commission: **Joseph V. Gartlan, Jr.**, Chairman; **W. Tayloe Murphy, Jr.**, Vice Chairman; **Robert L. Calhoun;** **Bernard S. Cohen;** **Jay W. DeBoer;** **Frank S. Ferguson;** **E. M. Miller, Jr.;** **Jackson E. Reasor, Jr.;** **James B. Wilkinson.**

Staff of the Virginia Register: **Jane D. Chaffin**, Registrar of Regulations.

PUBLICATION DEADLINES AND SCHEDULES

This schedule is available on the *Register's* Internet home page (<http://legis.state.va.us/codecomm/register/regindex.htm>).

October 1998 through September 1999

<u>Volume:Issue</u>	<u>Material Submitted By Noon*</u>	<u>Will Be Published On</u>
15:2	September 23, 1998	October 12, 1998
15:3	October 7, 1998	October 26, 1998
15:4	October 21, 1998	November 9, 1998
15:5	November 4, 1998	November 23, 1998
15:6	November 17, 1998 (Tuesday)	December 7, 1998
15:7	December 2, 1998	December 21, 1998
INDEX 1 - Volume 15		January 1999
15:8	December 15, 1998 (Tuesday)	January 4, 1999
15:9	December 29, 1998 (Tuesday)	January 18, 1999
15:10	January 13, 1999	February 1, 1999
15:11	January 27, 1999	February 15, 1999
15:12	February 10, 1999	March 1, 1999
15:13	February 24, 1999	March 15, 1999
15:14	March 10, 1999	March 29, 1999
INDEX 2 - Volume 15		April 1999
15:15	March 24, 1999	April 12, 1999
15:16	April 7, 1999	April 26, 1999
15:17	April 21, 1999	May 10, 1999
15:18	May 5, 1999	May 24, 1999
15:19	May 19, 1999	June 7, 1999
15:20	June 2, 1999	June 21, 1999
INDEX 3 - Volume 15		July 1999
15:21	June 16, 1999	July 5, 1999
15:22	June 30, 1999	July 19, 1999
15:23	July 14, 1999	August 2, 1999
15:24	July 28, 1999	August 16, 1999
15:25	August 11, 1999	August 30, 1999
15:26	August 25, 1999	September 13, 1999
FINAL INDEX - Volume 15		October 1999

*Filing deadlines are Wednesdays unless otherwise specified.

TABLE OF CONTENTS

CUMULATIVE TABLE OF VIRGINIA ADMINISTRATIVE CODE SECTIONS ADOPTED, AMENDED, OR REPEALED

Cumulative Table 89

NOTICES OF INTENDED REGULATORY ACTION

TITLE 8. EDUCATION

State Board of Education 106

TITLE 9. ENVIRONMENT

State Water Control Board 106

TITLE 12. HEALTH

State Board of Health 107

Department of Medical Assistance Services 109

TITLE 16. LABOR AND EMPLOYMENT

Governor's Employment and Training Department 110

TITLE 18. PROFESSIONAL AND OCCUPATIONAL LICENSING

Auctioneers Board 110

Board of Health Professions 111

Board of Medicine 111

TITLE 22. SOCIAL SERVICES

Department of Rehabilitative Services and Board of Rehabilitative Services 112

State Board of Social Services 113

PUBLIC COMMENT PERIODS - PROPOSED REGULATIONS

TITLE 11. GAMING

Virginia Racing Commission 115

PROPOSED REGULATIONS

TITLE 11. GAMING

VIRGINIA RACING COMMISSION

Regulations Pertaining to Horse Racing with Pari-Mutuel Wagering: Participants (amending 11 VAC 10-60-10, 11 VAC 10-60-20, 11 VAC 10-60-40, 11 VAC 10-60-70,

11 VAC 10-60-120, 11 VAC 10-60-130, 11 VAC 10-60-140, and 11 VAC 10-60-150; adding 11 VAC 10-60-15, 11 VAC 10-60-290, 11 VAC 10-60-300, 11 VAC 10-60-310, and 11 VAC 10-60-320; repealing 11 VAC 10-60-30 and 11 VAC 10-60-60). 116

FINAL REGULATIONS

TITLE 4. CONSERVATION AND NATURAL RESOURCES

DEPARTMENT OF MINES, MINERALS AND ENERGY

Virginia Gas and Oil Regulation (amending 4 VAC 25-150-10, 4 VAC 25-150-50, 4 VAC 25-150-60, 4 VAC 25-150-80 through 4 VAC 25-150-130, 4 VAC 25-150-160 through 4 VAC 25-150-360, 4 VAC 25-150-380 through 4 VAC 25-150-460, 4 VAC 25-150-500 through 4 VAC 25-150-530, 4 VAC 25-150-560, 4 VAC 25-150-580 through 4 VAC 25-150-610, and 4 VAC 25-150-650 through 4 VAC 25-150-740; adding 4 VAC 25-150-135, 4 VAC 25-150-435 and 4 VAC 25-150-711; repealing 4 VAC 25-150-70, 4 VAC 25-150-540, 4 VAC 25-150-570, 4 VAC 25-150-640 and 4 VAC 25-150-710). 135

TITLE 9. ENVIRONMENT

STATE AIR POLLUTION CONTROL BOARD

Regulations for the Control and Abatement of Air Pollution: General Provisions (Rev. A98) (amending 9 VAC 5-20-204 and 9 VAC 5-20-205). 174

TITLE 12. HEALTH

DEPARTMENT OF MEDICAL ASSISTANCE SERVICES

Withdrawal of Final Regulation and Notice of Change

State Programs: Part IV, Health Insurance Program for Working Uninsured Individuals (withdrawing 12 VAC 30-100-420, Program subscribers). 177

TITLE 19. PUBLIC SAFETY

DEPARTMENT OF STATE POLICE

Motor Vehicle Safety Inspection Rules and Regulations (amending 19 VAC 30-70-500). 177

THE LEGISLATIVE RECORD

HJR 432: Commission on the Condition and Future of Virginia's Cities 212

SJR 223: Standing Joint Subcommittee on Block Grants 213

Special Subcommittee on Business Tax Incentives 214

Special Joint Meeting on Education 215

Table of Contents

HJR 187: Joint Subcommittee to Study the Virginia Freedom of Information Act..... 216

SJR 91: Task Force on Stranded Costs and Related Issues 217

SJR 91: Task Force on State and Local Taxation 218

SJR 91: Task Force on Structure and Transition 219

SJR 91: Task Force on Consumer, Environment and Education 220

GENERAL NOTICES/ERRATA

SPECIAL JOINT SUBCOMMITTEE TO STUDY CERTIFICATE OF PUBLIC NEED

Invitation to Submit Written Proposals 223

STATE CORPORATION COMMISSION

ORDER EXTENDING TIME FOR FILING COMMENTS

In the Matter of Adopting Rules Governing the Filing of Applications for Approval Pursuant to Chapter 4 of Title 56 of the Code of Virginia 223

Bureau of Insurance

ADMINISTRATIVE LETTERS

Amendments to Rules Governing Minimum Standards for Medicare Supplement Policies (1998-9) 223

Revised Guidelines for Conducting Title Insurance Company/Underwriter Analyses of Escrow Accounts Maintained by Title Insurance Settlement Agents (All Changes to Administrative Letter 1998-1 are Italicized) (1998-10)..... 225

STATE BOARD OF HEALTH AND DEPARTMENT OF MEDICAL ASSISTANCE SERVICES

Notice Seeking Public Comment on Proposed Request for Certificate of Public Need Applications 229

DEPARTMENT OF MEDICAL ASSISTANCE SERVICES

Revised Final Regulation: Specialized Care Nursing Facility Services: Provider and Recipient Criteria..... 231

STATE WATER CONTROL BOARD

Proposed Consent Special Order - Town of Grottoes..... 236

Proposed Consent Special Order Amendment - Town of Strasburg..... 237

Proposed Consent Special Order - Ticonderoga Farms, Inc., and SWPP Development Corporation 237

Proposed Consent Special Order - Valley View Mobile Home Court 237

Proposed Consent Special Order - Virginia Metalcrafters, Inc.....238

VIRGINIA CODE COMMISSION

Notice to State Agencies.....238

Forms for Filing Material for Publication in *The Virginia Register of Regulations*.....238

ERRATA

VIRGINIA CODE COMMISSION

Correction of Page Numbers in 15:1 VA.R. September 28, 1998.....241

STATE WATER CONTROL BOARD

General Virginia Pollutant Discharge Elimination System (VPDES) Permit for Ready-Mixed Concrete Plants. (9 VAC 25-193-10 et seq.)241

CALENDAR OF EVENTS

EXECUTIVE

Open Meetings and Public Hearings242

INDEPENDENT

Open Meetings and Public Hearings266

LEGISLATIVE

Open Meetings and Public Hearings266

CHRONOLOGICAL LIST

Open Meetings269

Public Hearings.....271

CUMULATIVE TABLE OF VIRGINIA ADMINISTRATIVE CODE SECTIONS ADOPTED, AMENDED, OR REPEALED

The table printed below lists regulation sections, by Virginia Administrative Code (VAC) title, that have been amended, added or repealed in the *Virginia Register* since the regulations were originally published or last supplemented in VAC (the Spring 1998 VAC Supplement includes final regulations published through *Virginia Register* Volume 14, Issue 10, dated February 2, 1998). Emergency regulations, if any, are listed, followed by the designation "emer," and errata pertaining to final regulations are listed. Proposed regulations are not listed here. The table lists the sections in numerical order and shows action taken, the volume, issue and page number where the section appeared, and the effective date of the section.

SECTION NUMBER	ACTION	CITE	EFFECTIVE DATE
Title 1. Administration			
1 VAC 30-130-10	Amended	15:1 VA.R. 44 (4390)	9/15/98
1 VAC 75-30-60	Amended	14:25 VA.R. 4065	9/30/98
Title 2. Agriculture			
2 VAC 5-180-10	Amended	14:19 VA.R. 2666	7/8/98
2 VAC 5-180-20	Amended	14:19 VA.R. 2667	7/8/98
2 VAC 5-180-30	Amended	14:19 VA.R. 2668	7/8/98
2 VAC 5-180-50	Amended	14:19 VA.R. 2668	7/8/98
2 VAC 5-180-60	Amended	14:19 VA.R. 2668	7/8/98
2 VAC 5-180-80	Amended	14:19 VA.R. 2668	7/8/98
2 VAC 5-180-90	Amended	14:19 VA.R. 2669	7/8/98
2 VAC 5-180-120	Amended	14:19 VA.R. 2669	7/8/98
2 VAC 5-205-10 through 2 VAC 5-205-110	Added	14:19 VA.R. 2670	7/8/98
2 VAC 5-390-180	Amended	14:14 VA.R. 2136	3/1/98
Title 4. Conservation and Natural Resources			
4 VAC 5-20-20	Amended	14:24 VA.R. 3906	9/18/98
4 VAC 15-260-140	Amended	14:24 VA.R. 3907	9/1/98
4 VAC 15-260-170	Added	14:24 VA.R. 3907	9/16/98
4 VAC 15-290-140	Amended	14:16 VA.R. 2357	7/1/98
4 VAC 20-260-20	Amended	14:15 VA.R. 2231	3/13/98
4 VAC 20-280-10	Amended	14:16 VA.R. 2357	3/31/98
4 VAC 20-345-10	Added	14:15 VA.R. 2236	3/1/98
4 VAC 20-345-20	Added	14:15 VA.R. 2236	3/1/98
4 VAC 20-345-20	Amended	14:18 VA.R. 2513	5/4/98
4 VAC 20-345-30	Added	14:15 VA.R. 2236	3/1/98
4 VAC 20-345-40	Added	14:15 VA.R. 2237	3/1/98
4 VAC 20-345-40	Amended	14:18 VA.R. 2513	5/4/98
4 VAC 20-380-30	Amended	14:16 VA.R. 2357	3/31/98
4 VAC 20-380-60	Amended	14:16 VA.R. 2358	3/31/98
4 VAC 20-395-10 through 4 VAC 20-395-40	Added	14:22 VA.R. 3205-3206	7/1/98
4 VAC 20-500-40	Amended	14:14 VA.R. 2137	3/1/98
4 VAC 20-560-10	Amended	14:18 VA.R. 2514	5/1/98
4 VAC 20-560-20	Amended	14:18 VA.R. 2514	5/1/98
4 VAC 20-560-40	Amended	14:18 VA.R. 2515	5/1/98
4 VAC 20-560-50	Amended	14:18 VA.R. 2516	5/1/98
4 VAC 20-620-50	Amended	14:16 VA.R. 2358	4/1/98
4 VAC 20-620-60	Amended	14:16 VA.R. 2358	4/1/98
4 VAC 20-880-40	Amended	14:14 VA.R. 2137	3/1/98
4 VAC 20-880-40	Amended	14:18 VA.R. 2516	5/1/98
4 VAC 20-880-50	Amended	14:14 VA.R. 2138	3/1/98
4 VAC 20-880-50	Amended	14:18 VA.R. 2517	5/1/98

Cumulative Table of VAC Sections Adopted, Amended, or Repealed

SECTION NUMBER	ACTION	CITE	EFFECTIVE DATE
4 VAC 20-890-30	Amended	14:25 VA.R. 4065	8/5/98
4 VAC 20-910-45	Amended	14:12 VA.R. 1915	1/30/98
4 VAC 20-950-30	Amended	14:16 VA.R. 2358	4/1/98
4 VAC 20-950-45	Added	14:12 VA.R. 1915	1/30/98
4 VAC 20-950-45	Amended	14:16 VA.R. 2359	4/1/98
4 VAC 20-960-30	Amended	14:16 VA.R. 2359	4/1/98
4 VAC 20-960-45	Added	14:16 VA.R. 2359	4/1/98
4 VAC 20-1000-10	Added	14:12 VA.R. 1916	1/30/98
4 VAC 20-1000-20	Added	14:12 VA.R. 1916	1/30/98
4 VAC 20-1000-30	Added	14:12 VA.R. 1916	1/30/98
4 VAC 20-1000-40	Added	14:12 VA.R. 1916	1/30/98
4 VAC 25-35 (Forms)	Amended	15:1 VA.R. 46 (4392)	--
4 VAC 25-40-10	Amended	14:17 VA.R. 2428	7/1/98
4 VAC 25-40-20	Repealed	14:17 VA.R. 2430	7/1/98
4 VAC 25-40-25	Added	14:17 VA.R. 2430	7/1/98
4 VAC 25-40-30	Repealed	14:17 VA.R. 2430	7/1/98
4 VAC 25-40-40	Amended	14:17 VA.R. 2430	7/1/98
4 VAC 25-40-50	Amended	14:17 VA.R. 2430	7/1/98
4 VAC 25-40-60	Repealed	14:17 VA.R. 2431	7/1/98
4 VAC 25-40-70	Amended	14:17 VA.R. 2431	7/1/98
4 VAC 25-40-80	Repealed	14:17 VA.R. 2431	7/1/98
4 VAC 25-40-90	Amended	14:17 VA.R. 2431	7/1/98
4 VAC 25-40-100	Amended	14:17 VA.R. 2431	7/1/98
4 VAC 25-40-110	Amended	14:17 VA.R. 2432	7/1/98
4 VAC 25-40-120	Amended	14:17 VA.R. 2432	7/1/98
4 VAC 25-40-130	Amended	14:17 VA.R. 2432	7/1/98
4 VAC 25-40-140	Amended	14:17 VA.R. 2432	7/1/98
4 VAC 25-40-145	Added	14:17 VA.R. 2432	7/1/98
4 VAC 25-40-180	Amended	14:17 VA.R. 2432	7/1/98
4 VAC 25-40-200	Amended	14:17 VA.R. 2432	7/1/98
4 VAC 25-40-210	Amended	14:17 VA.R. 2432	7/1/98
4 VAC 25-40-220	Amended	14:17 VA.R. 2432	7/1/98
4 VAC 25-40-250	Amended	14:17 VA.R. 2432	7/1/98
4 VAC 25-40-270	Amended	14:17 VA.R. 2432	7/1/98
4 VAC 25-40-300	Amended	14:17 VA.R. 2432	7/1/98
4 VAC 25-40-310	Amended	14:17 VA.R. 2432	7/1/98
4 VAC 25-40-320	Repealed	14:17 VA.R. 2432	7/1/98
4 VAC 25-40-350	Amended	14:17 VA.R. 2432	7/1/98
4 VAC 25-40-385	Added	14:17 VA.R. 2433	7/1/98
4 VAC 25-40-388	Added	14:17 VA.R. 2433	7/1/98
4 VAC 25-40-390	Amended	14:17 VA.R. 2434	7/1/98
4 VAC 25-40-400	Amended	14:17 VA.R. 2434	7/1/98
4 VAC 25-40-440	Amended	14:17 VA.R. 2434	7/1/98
4 VAC 25-40-450	Amended	14:17 VA.R. 2434	7/1/98
4 VAC 25-40-460	Amended	14:17 VA.R. 2434	7/1/98
4 VAC 25-40-490	Amended	14:17 VA.R. 2434	7/1/98
4 VAC 25-40-500	Amended	14:17 VA.R. 2434	7/1/98
4 VAC 25-40-510	Amended	14:17 VA.R. 2434	7/1/98
4 VAC 25-40-520	Amended	14:17 VA.R. 2434	7/1/98
4 VAC 25-40-530	Amended	14:17 VA.R. 2434	7/1/98
4 VAC 25-40-540	Amended	14:17 VA.R. 2434	7/1/98
4 VAC 25-40-550	Amended	14:17 VA.R. 2434	7/1/98
4 VAC 25-40-590	Amended	14:17 VA.R. 2434	7/1/98
4 VAC 25-40-630	Amended	14:17 VA.R. 2434	7/1/98

Cumulative Table of VAC Sections Adopted, Amended, or Repealed

SECTION NUMBER	ACTION	CITE	EFFECTIVE DATE
4 VAC 25-40-660	Amended	14:17 VA.R. 2434	7/1/98
4 VAC 25-40-670	Amended	14:17 VA.R. 2435	7/1/98
4 VAC 25-40-690	Amended	14:17 VA.R. 2435	7/1/98
4 VAC 25-40-710	Amended	14:17 VA.R. 2435	7/1/98
4 VAC 25-40-720	Amended	14:17 VA.R. 2435	7/1/98
4 VAC 25-40-730	Repealed	14:17 VA.R. 2435	7/1/98
4 VAC 25-40-750	Repealed	14:17 VA.R. 2435	7/1/98
4 VAC 25-40-770	Amended	14:17 VA.R. 2435	7/1/98
4 VAC 25-40-780	Amended	14:17 VA.R. 2435	7/1/98
4 VAC 25-40-790	Amended	14:17 VA.R. 2436	7/1/98
4 VAC 25-40-800	Amended	14:17 VA.R. 2436	7/1/98
4 VAC 25-40-810	Amended	14:17 VA.R. 2437	7/1/98
4 VAC 25-40-820	Amended	14:17 VA.R. 2437	7/1/98
4 VAC 25-40-830	Amended	14:17 VA.R. 2438	7/1/98
4 VAC 25-40-870	Amended	14:17 VA.R. 2438	7/1/98
4 VAC 25-40-880	Amended	14:17 VA.R. 2438	7/1/98
4 VAC 25-40-890	Amended	14:17 VA.R. 2438	7/1/98
4 VAC 25-40-895	Added	14:17 VA.R. 2438	7/1/98
4 VAC 25-40-900	Amended	14:17 VA.R. 2438	7/1/98
4 VAC 25-40-910	Amended	14:17 VA.R. 2438	7/1/98
4 VAC 25-40-920	Amended	14:17 VA.R. 2439	7/1/98
4 VAC 25-40-930	Amended	14:17 VA.R. 2439	7/1/98
4 VAC 25-40-940	Repealed	14:17 VA.R. 2439	7/1/98
4 VAC 25-40-960	Repealed	14:17 VA.R. 2439	7/1/98
4 VAC 25-40-970	Amended	14:17 VA.R. 2439	7/1/98
4 VAC 25-40-1030	Amended	14:17 VA.R. 2439	7/1/98
4 VAC 25-40-1060	Amended	14:17 VA.R. 2439	7/1/98
4 VAC 25-40-1070	Amended	14:17 VA.R. 2439	7/1/98
4 VAC 25-40-1090	Amended	14:17 VA.R. 2439	7/1/98
4 VAC 25-40-1100	Amended	14:17 VA.R. 2439	7/1/98
4 VAC 25-40-1130	Amended	14:17 VA.R. 2440	7/1/98
4 VAC 25-40-1140	Amended	14:17 VA.R. 2440	7/1/98
4 VAC 25-40-1180	Amended	14:17 VA.R. 2440	7/1/98
4 VAC 25-40-1200	Amended	14:17 VA.R. 2440	7/1/98
4 VAC 25-40-1210	Amended	14:17 VA.R. 2440	7/1/98
4 VAC 25-40-1220	Amended	14:17 VA.R. 2440	7/1/98
4 VAC 25-40-1250	Amended	14:17 VA.R. 2440	7/1/98
4 VAC 25-40-1260	Amended	14:17 VA.R. 2440	7/1/98
4 VAC 25-40-1280	Amended	14:17 VA.R. 2440	7/1/98
4 VAC 25-40-1300	Repealed	14:17 VA.R. 2440	7/1/98
4 VAC 25-40-1310	Repealed	14:17 VA.R. 2440	7/1/98
4 VAC 25-40-1320	Amended	14:17 VA.R. 2440	7/1/98
4 VAC 25-40-1340	Amended	14:17 VA.R. 2440	7/1/98
4 VAC 25-40-1350	Amended	14:17 VA.R. 2440	7/1/98
4 VAC 25-40-1370	Amended	14:17 VA.R. 2440	7/1/98
4 VAC 25-40-1490	Repealed	14:17 VA.R. 2440	7/1/98
4 VAC 25-40-1540	Amended	14:17 VA.R. 2440	7/1/98
4 VAC 25-40-1550	Amended	14:17 VA.R. 2440	7/1/98
4 VAC 25-40-1560	Amended	14:17 VA.R. 2441	7/1/98
4 VAC 25-40-1580	Amended	14:17 VA.R. 2441	7/1/98
4 VAC 25-40-1590	Amended	14:17 VA.R. 2441	7/1/98
4 VAC 25-40-1670	Amended	14:17 VA.R. 2441	7/1/98
4 VAC 25-40-1685	Added	14:17 VA.R. 2441	7/1/98
4 VAC 25-40-1690	Amended	14:17 VA.R. 2441	7/1/98
4 VAC 25-40-1740	Amended	14:17 VA.R. 2441	7/1/98

Cumulative Table of VAC Sections Adopted, Amended, or Repealed

SECTION NUMBER	ACTION	CITE	EFFECTIVE DATE
4 VAC 25-40-1780	Amended	14:17 VA.R. 2441	7/1/98
4 VAC 25-40-1785	Added	14:17 VA.R. 2442	7/1/98
4 VAC 25-40-1810	Amended	14:17 VA.R. 2442	7/1/98
4 VAC 25-40-1880	Amended	14:17 VA.R. 2442	7/1/98
4 VAC 25-40-1940	Repealed	14:17 VA.R. 2442	7/1/98
4 VAC 25-40-2010	Amended	14:17 VA.R. 2442	7/1/98
4 VAC 25-40-2015	Added	14:17 VA.R. 2442	7/1/98
4 VAC 25-40-2040	Amended	14:17 VA.R. 2442	7/1/98
4 VAC 25-40-2080	Amended	14:17 VA.R. 2442	7/1/98
4 VAC 25-40-2100	Amended	14:17 VA.R. 2442	7/1/98
4 VAC 25-40-2140	Amended	14:17 VA.R. 2442	7/1/98
4 VAC 25-40-2170	Amended	14:17 VA.R. 2442	7/1/98
4 VAC 25-40-2180	Amended	14:17 VA.R. 2442	7/1/98
4 VAC 25-40-2210	Amended	14:17 VA.R. 2442	7/1/98
4 VAC 25-40-2220	Amended	14:17 VA.R. 2442	7/1/98
4 VAC 25-40-2250	Amended	14:17 VA.R. 2442	7/1/98
4 VAC 25-40-2260	Repealed	14:17 VA.R. 2443	7/1/98
4 VAC 25-40-2270	Amended	14:17 VA.R. 2443	7/1/98
4 VAC 25-40-2280	Amended	14:17 VA.R. 2443	7/1/98
4 VAC 25-40-2300	Amended	14:17 VA.R. 2443	7/1/98
4 VAC 25-40-2340	Amended	14:17 VA.R. 2443	7/1/98
4 VAC 25-40-2390	Amended	14:17 VA.R. 2443	7/1/98
4 VAC 25-40-2400	Amended	14:17 VA.R. 2443	7/1/98
4 VAC 25-40-2410	Amended	14:17 VA.R. 2443	7/1/98
4 VAC 25-40-2420	Amended	14:17 VA.R. 2443	7/1/98
4 VAC 25-40-2440	Amended	14:17 VA.R. 2443	7/1/98
4 VAC 25-40-2450	Amended	14:17 VA.R. 2443	7/1/98
4 VAC 25-40-2480	Amended	14:17 VA.R. 2443	7/1/98
4 VAC 25-40-2490	Amended	14:17 VA.R. 2443	7/1/98
4 VAC 25-40-2500	Amended	14:17 VA.R. 2443	7/1/98
4 VAC 25-40-2510	Repealed	14:17 VA.R. 2443	7/1/98
4 VAC 25-40-2530	Amended	14:17 VA.R. 2443	7/1/98
4 VAC 25-40-2540	Amended	14:17 VA.R. 2443	7/1/98
4 VAC 25-40-2550	Amended	14:17 VA.R. 2443	7/1/98
4 VAC 25-40-2590	Amended	14:17 VA.R. 2444	7/1/98
4 VAC 25-40-2610	Amended	14:17 VA.R. 2444	7/1/98
4 VAC 25-40-2650	Amended	14:17 VA.R. 2444	7/1/98
4 VAC 25-40-2660	Amended	14:17 VA.R. 2444	7/1/98
4 VAC 25-40-2680	Amended	14:17 VA.R. 2444	7/1/98
4 VAC 25-40-2700	Amended	14:17 VA.R. 2444	7/1/98
4 VAC 25-40-2720	Amended	14:17 VA.R. 2444	7/1/98
4 VAC 25-40-2750	Amended	14:17 VA.R. 2444	7/1/98
4 VAC 25-40-2760	Amended	14:17 VA.R. 2444	7/1/98
4 VAC 25-40-2770	Amended	14:17 VA.R. 2444	7/1/98
4 VAC 25-40-2790	Amended	14:17 VA.R. 2444	7/1/98
4 VAC 25-40-2800	Amended	14:17 VA.R. 2445	7/1/98
4 VAC 25-40-2810	Amended	14:17 VA.R. 2445	7/1/98
4 VAC 25-40-2820	Amended	14:17 VA.R. 2445	7/1/98
4 VAC 25-40-2850	Amended	14:17 VA.R. 2445	7/1/98
4 VAC 25-40-2870	Amended	14:17 VA.R. 2445	7/1/98
4 VAC 25-40-2880	Amended	14:17 VA.R. 2445	7/1/98
4 VAC 25-40-2910	Amended	14:17 VA.R. 2445	7/1/98
4 VAC 25-40-2915	Added	14:17 VA.R. 2445	7/1/98
4 VAC 25-40-2920	Amended	14:17 VA.R. 2445	7/1/98
4 VAC 25-40-2930	Amended	14:17 VA.R. 2445	7/1/98

Cumulative Table of VAC Sections Adopted, Amended, or Repealed

SECTION NUMBER	ACTION	CITE	EFFECTIVE DATE
4 VAC 25-40-2980	Amended	14:17 VA.R. 2445	7/1/98
4 VAC 25-40-3000	Amended	14:17 VA.R. 2445	7/1/98
4 VAC 25-40-3030	Amended	14:17 VA.R. 2446	7/1/98
4 VAC 25-40-3050	Amended	14:17 VA.R. 2446	7/1/98
4 VAC 25-40-3070	Amended	14:17 VA.R. 2446	7/1/98
4 VAC 25-40-3080	Amended	14:17 VA.R. 2446	7/1/98
4 VAC 25-40-3110	Amended	14:17 VA.R. 2446	7/1/98
4 VAC 25-40-3120	Amended	14:17 VA.R. 2446	7/1/98
4 VAC 25-40-3160	Amended	14:17 VA.R. 2447	7/1/98
4 VAC 25-40-3170	Amended	14:17 VA.R. 2447	7/1/98
4 VAC 25-40-3220	Amended	14:17 VA.R. 2447	7/1/98
4 VAC 25-40-3230	Repealed	14:17 VA.R. 2447	7/1/98
4 VAC 25-40-3240	Amended	14:17 VA.R. 2447	7/1/98
4 VAC 25-40-3280	Amended	14:17 VA.R. 2447	7/1/98
4 VAC 25-40-3290	Amended	14:17 VA.R. 2447	7/1/98
4 VAC 25-40-3300	Amended	14:17 VA.R. 2447	7/1/98
4 VAC 25-40-3310	Amended	14:17 VA.R. 2447	7/1/98
4 VAC 25-40-3320	Amended	14:17 VA.R. 2447	7/1/98
4 VAC 25-40-3325	Added	14:17 VA.R. 2447	7/1/98
4 VAC 25-40-3328	Added	14:17 VA.R. 2447	7/1/98
4 VAC 25-40-3330	Amended	14:17 VA.R. 2447	7/1/98
4 VAC 25-40-3340	Amended	14:17 VA.R. 2447	7/1/98
4 VAC 25-40-3350	Amended	14:17 VA.R. 2447	7/1/98
4 VAC 25-40-3420	Amended	14:17 VA.R. 2447	7/1/98
4 VAC 25-40-3430	Amended	14:17 VA.R. 2448	7/1/98
4 VAC 25-40-3450	Amended	14:17 VA.R. 2448	7/1/98
4 VAC 25-40-3460	Amended	14:17 VA.R. 2448	7/1/98
4 VAC 25-40-3475	Added	14:17 VA.R. 2448	7/1/98
4 VAC 25-40-3478	Added	14:17 VA.R. 2448	7/1/98
4 VAC 25-40-3590	Amended	14:17 VA.R. 2448	7/1/98
4 VAC 25-40-3595	Added	14:17 VA.R. 2448	7/1/98
4 VAC 25-40-3620	Amended	14:17 VA.R. 2448	7/1/98
4 VAC 25-40-3660	Amended	14:17 VA.R. 2448	7/1/98
4 VAC 25-40-3680	Amended	14:17 VA.R. 2448	7/1/98
4 VAC 25-40-3690	Amended	14:17 VA.R. 2448	7/1/98
4 VAC 25-40-3700	Amended	14:17 VA.R. 2448	7/1/98
4 VAC 25-40-3710	Amended	14:17 VA.R. 2448	7/1/98
4 VAC 25-40-3720	Amended	14:17 VA.R. 2448	7/1/98
4 VAC 25-40-3830	Amended	14:17 VA.R. 2448	7/1/98
4 VAC 25-40-3840	Amended	14:17 VA.R. 2449	7/1/98
4 VAC 25-40-3855	Added	14:17 VA.R. 2449	7/1/98
4 VAC 25-40-3890	Amended	14:17 VA.R. 2449	7/1/98
4 VAC 25-40-3930	Amended	14:17 VA.R. 2449	7/1/98
4 VAC 25-40-3955	Added	14:17 VA.R. 2449	7/1/98
4 VAC 25-40-3958	Added	14:17 VA.R. 2450	7/1/98
4 VAC 25-40-3980	Amended	14:17 VA.R. 2450	7/1/98
4 VAC 25-40-3990	Amended	14:17 VA.R. 2450	7/1/98
4 VAC 25-40-4060	Amended	14:17 VA.R. 2450	7/1/98
4 VAC 25-40-4090	Amended	14:17 VA.R. 2450	7/1/98
4 VAC 25-40-4100	Amended	14:17 VA.R. 2450	7/1/98
4 VAC 25-40-4110	Amended	14:17 VA.R. 2451	7/1/98
4 VAC 25-40-4140	Amended	14:17 VA.R. 2451	7/1/98
4 VAC 25-40-4160	Amended	14:17 VA.R. 2451	7/1/98
4 VAC 25-40-4220	Amended	14:17 VA.R. 2451	7/1/98
4 VAC 25-40-4230	Amended	14:17 VA.R. 2451	7/1/98

Cumulative Table of VAC Sections Adopted, Amended, or Repealed

SECTION NUMBER	ACTION	CITE	EFFECTIVE DATE
4 VAC 25-40-4260	Amended	14:17 VA.R. 2451	7/1/98
4 VAC 25-40-4280	Amended	14:17 VA.R. 2451	7/1/98
4 VAC 25-40-4290	Amended	14:17 VA.R. 2452	7/1/98
4 VAC 25-40-4320	Amended	14:17 VA.R. 2452	7/1/98
4 VAC 25-40-4330	Amended	14:17 VA.R. 2452	7/1/98
4 VAC 25-40-4350	Amended	14:17 VA.R. 2452	7/1/98
4 VAC 25-40-4430	Amended	14:17 VA.R. 2452	7/1/98
4 VAC 25-40-4440	Amended	14:17 VA.R. 2452	7/1/98
4 VAC 25-40-4460	Amended	14:17 VA.R. 2452	7/1/98
4 VAC 25-40-4540	Amended	14:17 VA.R. 2452	7/1/98
4 VAC 25-40-4590	Amended	14:17 VA.R. 2452	7/1/98
4 VAC 25-40-4650	Amended	14:17 VA.R. 2452	7/1/98
4 VAC 25-40-4750	Amended	14:17 VA.R. 2452	7/1/98
4 VAC 25-40-4770	Amended	14:17 VA.R. 2452	7/1/98
4 VAC 25-40-4910	Amended	14:17 VA.R. 2452	7/1/98
4 VAC 25-40-4920	Amended	14:17 VA.R. 2452	7/1/98
4 VAC 25-40-4970	Amended	14:17 VA.R. 2452	7/1/98
4 VAC 25-40-4980	Amended	14:17 VA.R. 2452	7/1/98
4 VAC 25-40-5040	Repealed	14:17 VA.R. 2452	7/1/98
4 VAC 25-40-5050	Repealed	14:17 VA.R. 2453	7/1/98
4 VAC 25-40-5060	Amended	14:17 VA.R. 2453	7/1/98
4 VAC 25-40-5070	Amended	14:17 VA.R. 2453	7/1/98
4 VAC 25-40-5120	Amended	14:17 VA.R. 2453	7/1/98
4 VAC 25-40-5170	Amended	14:17 VA.R. 2453	7/1/98
4 VAC 25-40-5180	Amended	14:17 VA.R. 2453	7/1/98
4 VAC 25-40-5200	Amended	14:17 VA.R. 2453	7/1/98
4 VAC 25-40-5210	Amended	14:17 VA.R. 2453	7/1/98
4 VAC 25-40-5230	Amended	14:17 VA.R. 2454	7/1/98
4 VAC 25-40-5290	Amended	14:17 VA.R. 2454	7/1/98
4 VAC 25-40-5310	Amended	14:17 VA.R. 2454	7/1/98
4 VAC 25-40-5320	Amended	14:17 VA.R. 2454	7/1/98
4 VAC 25-40-5330	Amended	14:17 VA.R. 2454	7/1/98
4 VAC 25-40-5340	Amended	14:17 VA.R. 2454	7/1/98
4 VAC 25-40-5370	Amended	14:17 VA.R. 2454	7/1/98
4 VAC 25-40-5400	Amended	14:17 VA.R. 2454	7/1/98
4 VAC 25-40-5450	Amended	14:17 VA.R. 2454	7/1/98
4 VAC 25-40-5470	Amended	14:17 VA.R. 2454	7/1/98
4 VAC 25-40-5550	Amended	14:17 VA.R. 2454	7/1/98
4 VAC 25-40-5580	Amended	14:17 VA.R. 2454	7/1/98
4 VAC 25-40-5590	Amended	14:17 VA.R. 2455	7/1/98
4 VAC 25-40-5630	Amended	14:17 VA.R. 2455	7/1/98
4 VAC 25-40-5660	Amended	14:17 VA.R. 2455	7/1/98
4 VAC 25-40-5670	Amended	14:17 VA.R. 2455	7/1/98
4 VAC 25-40-5680	Repealed	14:17 VA.R. 2455	7/1/98
4 VAC 25-40-5690	Repealed	14:17 VA.R. 2455	7/1/98
4 VAC 25-40-5710	Amended	14:17 VA.R. 2455	7/1/98
4 VAC 25-40-5720	Repealed	14:17 VA.R. 2455	7/1/98
4 VAC 25-40-5730	Repealed	14:17 VA.R. 2455	7/1/98
4 VAC 25-40-5740	Repealed	14:17 VA.R. 2456	7/1/98
4 VAC 25-40-5750	Added	14:17 VA.R. 2456	7/1/98
4 VAC 25-40-5760	Added	14:17 VA.R. 2456	7/1/98
4 VAC 25-40-5770	Added	14:17 VA.R. 2457	7/1/98
4 VAC 25-40-5780	Added	14:17 VA.R. 2457	7/1/98
Title 6. Criminal Justice and Corrections			
6 VAC 15-60-10 through	Repealed	14:17 VA.R. 2457	9/1/98

Cumulative Table of VAC Sections Adopted, Amended, or Repealed

SECTION NUMBER	ACTION	CITE	EFFECTIVE DATE
6 VAC 15-60-100			
6 VAC 15-61-10 through 6 VAC 15-61-300	Added	14:17 VA.R. 2457	9/1/98
6 VAC 20-170-10	Amended	14:24 VA.R. 3908	9/16/98
6 VAC 20-170-80	Amended	14:24 VA.R. 3910	9/16/98
6 VAC 20-170-90	Amended	14:24 VA.R. 3911	9/16/98
6 VAC 20-170-270	Amended	14:24 VA.R. 3911	9/16/98
6 VAC 20-170-350	Amended	14:24 VA.R. 3912	9/16/98
6 VAC 20-170-470	Amended	14:24 VA.R. 3913	9/16/98
6 VAC 20-170-475	Amended	14:24 VA.R. 3913	9/16/98
6 VAC 20-170-520	Amended	14:24 VA.R. 3913	9/16/98
6 VAC 20-170-530	Amended	14:24 VA.R. 3913	9/16/98
6 VAC 20-170-540	Amended	14:24 VA.R. 3914	9/16/98
6 VAC 20-170-550	Amended	14:24 VA.R. 3915	9/16/98
6 VAC 20-170-615	Amended	14:24 VA.R. 3916	9/16/98
6 VAC 20-170-617	Amended	14:24 VA.R. 3919	9/16/98
6 VAC 20-170-626	Added	14:24 VA.R. 3919	9/16/98
6 VAC 20-170-627	Added	14:24 VA.R. 3919	9/16/98
6 VAC 20-170-1000	Amended	14:24 VA.R. 3919	9/16/98
6 VAC 20-170-1110	Added	14:24 VA.R. 3921	9/16/98
Title 8. Education			
8 VAC 20-20-750	Repealed	14:20 VA.R. 2754	7/22/98
8 VAC 20-20-770	Repealed	14:20 VA.R. 2754	7/22/98
8 VAC 20-20-780	Repealed	14:20 VA.R. 2754	7/22/98
8 VAC 20-20-790	Repealed	14:20 VA.R. 2754	7/22/98
8 VAC 20-21-425	Added	14:20 VA.R. 2754	7/22/98
8 VAC 20-21-430	Added	14:20 VA.R. 2755	7/22/98
8 VAC 20-21-435	Added	14:20 VA.R. 2756	7/22/98
8 VAC 20-21-440	Added	14:20 VA.R. 2757	7/22/98
8 VAC 20-21-445	Added	14:20 VA.R. 2758	7/22/98
Title 9. Environment			
9 VAC 5-20-203	Amended	14:11 VA.R. 1804	4/1/98
9 VAC 5-20-204	Amended	14:11 VA.R. 1804	4/1/98
9 VAC 5-20-205	Amended	14:11 VA.R. 1805	4/1/98
9 VAC 5-20-220	Added	14:11 VA.R. 1812	4/1/98
9 VAC 5-20-230	Added	14:11 VA.R. 1812	4/1/98
9 VAC 5-50-400	Amended	14:11 VA.R. 1807	4/1/98
9 VAC 5-60-60	Amended	14:11 VA.R. 1807	4/1/98
9 VAC 5-60-90	Amended	14:11 VA.R. 1807	4/1/98
9 VAC 5-60-100	Amended	14:11 VA.R. 1808	4/1/98
9 VAC 5-80-40	Repealed	14:11 VA.R. 1813	4/1/98
9 VAC 5-80-800	Added	14:11 VA.R. 1820	4/1/98
9 VAC 5-80-810	Added	14:11 VA.R. 1820	4/1/98
9 VAC 5-80-820	Added	14:11 VA.R. 1822	4/1/98
9 VAC 5-80-830	Added	14:11 VA.R. 1823	4/1/98
9 VAC 5-80-840	Added	14:11 VA.R. 1823	4/1/98
9 VAC 5-80-850	Added	14:11 VA.R. 1823	4/1/98
9 VAC 5-80-860	Added	14:11 VA.R. 1825	4/1/98
9 VAC 5-80-870	Added	14:11 VA.R. 1825	4/1/98
9 VAC 5-80-880	Added	14:11 VA.R. 1825	4/1/98
9 VAC 5-80-890	Added	14:11 VA.R. 1826	4/1/98
9 VAC 5-80-900	Added	14:11 VA.R. 1826	4/1/98
9 VAC 5-80-910	Added	14:11 VA.R. 1826	4/1/98
9 VAC 5-80-920	Added	14:11 VA.R. 1826	4/1/98
9 VAC 5-80-930	Added	14:11 VA.R. 1826	4/1/98

Cumulative Table of VAC Sections Adopted, Amended, or Repealed

SECTION NUMBER	ACTION	CITE	EFFECTIVE DATE
9 VAC 5-80-940	Added	14:11 VA.R. 1826	4/1/98
9 VAC 5-80-950	Added	14:11 VA.R. 1826	4/1/98
9 VAC 5-80-960	Added	14:11 VA.R. 1826	4/1/98
9 VAC 5-80-970	Added	14:11 VA.R. 1827	4/1/98
9 VAC 5-80-980	Added	14:11 VA.R. 1827	4/1/98
9 VAC 5-80-990	Added	14:11 VA.R. 1828	4/1/98
9 VAC 5-80-1000	Added	14:11 VA.R. 1828	4/1/98
9 VAC 5-80-1010	Added	14:11 VA.R. 1828	4/1/98
9 VAC 5-80-1020	Added	14:11 VA.R. 1829	4/1/98
9 VAC 5-80-1030	Added	14:11 VA.R. 1830	4/1/98
9 VAC 5-80-1040	Added	14:11 VA.R. 1831	4/1/98
9 VAC 5-190-80	Erratum	14:12 VA.R. 1937	--
9 VAC 25-31-800	Erratum	14:12 VA.R. 1937	--
9 VAC 25-31-800	Erratum	14:17 VA.R. 2477	--
9 VAC 25-31-840	Erratum	14:12 VA.R. 1937	--
9 VAC 25-31-900	Erratum	14:17 VA.R. 2477	--
9 VAC 25-31-920	Amended	14:16 VA.R. 2360	5/27/98
9 VAC 25-90-10 through 9 VAC 25-90-70	Repealed	14:18 VA.R. 2517	6/24/98
9 VAC 25-91-10 through 9 VAC 25-91-220	Added	14:18 VA.R. 2518	6/24/98
9 VAC 25-91-20	Erratum	14:23 VA.R. 3682	--
9 VAC 25-91-120	Erratum	14:23 VA.R. 3682	--
9 VAC 25-91-130	Erratum	14:23 VA.R. 3682	--
9 VAC 25-91-170	Erratum	14:23 VA.R. 3682	--
9 VAC 25-91-180	Erratum	14:23 VA.R. 3682	--
9 VAC 25-91-220	Erratum	14:23 VA.R. 3682	--
9 VAC 25-100-10 through 9 VAC 25-100-70	Repealed	14:18 VA.R. 2547	6/24/98
9 VAC 25-101-10 through 9 VAC 25-101-70	Added	14:18 VA.R. 2547	6/24/98
9 VAC 25-101-40	Erratum	14:23 VA.R. 3682	--
9 VAC 25-101-50	Erratum	14:23 VA.R. 3682	--
9 VAC 25-130-10 through 9 VAC 25-130-100	Repealed	14:18 VA.R. 2517	6/24/98
9 VAC 25-140-10 through 9 VAC 25-140-110	Repealed	14:18 VA.R. 2518	6/24/98
9 VAC 25-193-10 through 9 VAC 25-193-80	Added	14:24 VA.R. 3922	10/1/98
9 VAC 25-196-50	Erratum	14:12 VA.R. 1937	--
9 VAC 25-196-70	Erratum	14:12 VA.R. 1937	--
9 VAC 25-260-20	Erratum	14:12 VA.R. 1937	--
9 VAC 25-260-110	Erratum	14:12 VA.R. 1937	--
9 VAC 25-260-140	Erratum	14:12 VA.R. 1937	--
9 VAC 25-260-350	Erratum	14:12 VA.R. 1937	--
9 VAC 25-260-370	Erratum	14:12 VA.R. 1937	--
9 VAC 25-260-390	Erratum	14:12 VA.R. 1937	--
9 VAC 25-260-400	Erratum	14:12 VA.R. 1937	--
9 VAC 25-260-450	Erratum	14:12 VA.R. 1937	--
9 VAC 25-260-540	Erratum	14:12 VA.R. 1937	--
9 VAC 25-590-10 through 9 VAC 25-590-230	Amended	14:23 VA.R. 3607	9/2/98
9 VAC 25-590-240	Added	14:23 VA.R. 3621	9/2/98
9 VAC 25-590-250	Added	14:23 VA.R. 3621	9/2/98
9 VAC 25-590-260	Added	14:23 VA.R. 3621	9/2/98

Cumulative Table of VAC Sections Adopted, Amended, or Repealed

SECTION NUMBER	ACTION	CITE	EFFECTIVE DATE
9 VAC 25-590, Appendix I	Amended	14:23 VA.R. 3621	9/2/98
9 VAC 25-590, Appendix II	Amended	14:23 VA.R. 3623	9/2/98
9 VAC 25-590, Appendices V through X	Amended	14:23 VA.R. 3625	9/2/98
9 VAC 25-590, Appendix XI	Added	14:23 VA.R. 3631	9/2/98
Title 10. Finance and Financial Institutions			
10 VAC 5-60-40	Amended	14:14 VA.R. 2139	3/10/98
10 VAC 5-60-50	Amended	14:14 VA.R. 2139	3/10/98
10 VAC 5-70-20	Amended	14:14 VA.R. 2140	3/10/98
10 VAC 5-70-30	Amended	14:14 VA.R. 2140	3/10/98
10 VAC 5-70-50	Amended	14:14 VA.R. 2140	3/10/98
Title 11. Gaming			
11 VAC 10-70-20	Amended	14:11 VA.R. 1831	3/19/98
11 VAC 10-70-30	Amended	14:11 VA.R. 1831	3/19/98
11 VAC 10-70-40	Amended	14:11 VA.R. 1831	3/19/98
11 VAC 10-70-50	Amended	14:11 VA.R. 1831	3/19/98
11 VAC 10-70-60	Amended	14:11 VA.R. 1832	3/19/98
11 VAC 10-70-70	Amended	14:11 VA.R. 1832	3/19/98
11 VAC 10-70-80	Amended	14:11 VA.R. 1833	3/19/98
11 VAC 10-70-110	Amended	14:11 VA.R. 1833	3/19/98
11 VAC 10-70-170	Amended	14:11 VA.R. 1833	3/19/98
11 VAC 10-70-180	Amended	14:11 VA.R. 1833	3/19/98
11 VAC 10-90-10	Amended	14:11 VA.R. 1835	3/19/98
11 VAC 10-90-20	Amended	14:11 VA.R. 1835	3/19/98
11 VAC 10-90-30	Amended	14:11 VA.R. 1835	3/19/98
11 VAC 10-90-40	Amended	14:11 VA.R. 1835	3/19/98
11 VAC 10-90-50	Amended	14:11 VA.R. 1835	3/19/98
11 VAC 10-90-60	Amended	14:11 VA.R. 1836	3/19/98
11 VAC 10-180-10	Amended	14:22 VA.R. 3207	8/20/98
11 VAC 10-180-20	Amended	14:22 VA.R. 3207	8/20/98
11 VAC 10-180-30	Amended	14:22 VA.R. 3208	8/20/98
11 VAC 10-180-50	Amended	14:22 VA.R. 3209	8/20/98
11 VAC 10-180-60	Amended	14:22 VA.R. 3211	8/20/98
11 VAC 10-180-70	Amended	14:22 VA.R. 3212	8/20/98
11 VAC 10-180-80	Amended	14:22 VA.R. 3213	8/20/98
11 VAC 10-180-90	Amended	14:22 VA.R. 3213	8/20/98
Title 12. Health			
12 VAC 5-90-230	Added	14:26 VA.R. 4250	10/14/98
12 VAC 5-90-240	Added	14:26 VA.R. 4250	10/14/98
12 VAC 5-90-250	Added	14:26 VA.R. 4251	10/14/98
12 VAC 5-90-260	Added	14:26 VA.R. 4251	10/14/98
12 VAC 5-90-270	Added	14:26 VA.R. 4251	10/14/98
12 VAC 5-210-10	Amended	14:15 VA.R. 2237	6/1/98
12 VAC 5-210-20	Amended	14:15 VA.R. 2243	6/1/98
12 VAC 5-220-10	Amended	14:12 VA.R. 1917	4/2/98
12 VAC 5-220-105	Added	14:12 VA.R. 1920	4/2/98
12 VAC 5-220-150	Amended	14:12 VA.R. 1920	4/2/98
12 VAC 5-220-180	Amended	14:12 VA.R. 1920	4/2/98
12 VAC 5-220-200	Amended	14:12 VA.R. 1921	4/2/98
12 VAC 5-220-230	Amended	14:12 VA.R. 1923	4/2/98
12 VAC 5-220-280	Amended	14:12 VA.R. 1924	4/2/98
12 VAC 5-220-290	Amended	14:12 VA.R. 1925	4/2/98
12 VAC 5-220-385	Amended	14:12 VA.R. 1925	4/2/98
12 VAC 5-220-500	Amended	14:12 VA.R. 1926	4/2/98
12 VAC 30-20-170	Amended	14:26 VA.R. 4252	10/15/98

Cumulative Table of VAC Sections Adopted, Amended, or Repealed

SECTION NUMBER	ACTION	CITE	EFFECTIVE DATE
12 VAC 30-50-30	Amended	14:18 VA.R. 2568	7/1/98
12 VAC 30-50-70	Amended	14:18 VA.R. 2568	7/1/98
12 VAC 30-50-100	Amended	14:18 VA.R. 2571	7/1/98
12 VAC 30-50-100 emer	Amended	14:22 VA.R. 3270	7/1/98 - 6/30/99
12 VAC 30-50-100	Amended	14:25 VA.R. 4066	9/30/98
12 VAC 30-50-105	Amended	14:18 VA.R. 2573	7/1/98
12 VAC 30-50-105 emer	Amended	14:22 VA.R. 3272	7/1/98 - 6/30/99
12 VAC 30-50-105	Amended	14:25 VA.R. 4068	9/30/98
12 VAC 30-50-140	Amended	14:12 VA.R. 1926	4/1/98
12 VAC 30-50-140	Amended	14:18 VA.R. 2574	7/1/98
12 VAC 30-50-150	Amended	14:12 VA.R. 1927	4/1/98
12 VAC 30-50-160	Amended	14:18 VA.R. 2564	7/1/98
12 VAC 30-50-160	Amended	14:26 VA.R. 4252	10/15/98
12 VAC 30-50-200	Amended	14:18 VA.R. 2579	7/1/98
12 VAC 30-50-220	Amended	14:18 VA.R. 2569	7/1/98
12 VAC 30-50-229.1	Added	14:18 VA.R. 2581	7/1/98
12 VAC 30-50-540	Amended	14:18 VA.R. 2575	7/1/98
12 VAC 30-50-550	Added	14:18 VA.R. 2576	7/1/98
12 VAC 30-50-560	Added	14:18 VA.R. 2577	7/1/98
12 VAC 30-50-570	Added	14:18 VA.R. 2578	7/1/98
12 VAC 30-60-20 emer	Amended	14:22 VA.R. 3273	7/1/98 - 6/30/99
12 VAC 30-60-25 emer	Amended	14:22 VA.R. 3274	7/1/98 - 6/30/99
12 VAC 30-60-40	Amended	14:12 VA.R. 1928	4/1/98
12 VAC 30-60-40	Amended	14:26 VA.R. 4254	10/15/98
12 VAC 30-60-90	Repealed	14:17 VA.R. 2465	6/10/98
12 VAC 30-60-120	Amended	14:12 VA.R. 1929	4/1/98
12 VAC 30-60-320	Amended	14:26 VA.R. 4257	10/15/98
12 VAC 30-60-340	Amended	14:26 VA.R. 4259	10/15/98
12 VAC 30-70-200 through 12 VAC 30-70-500 emer	Amended	14:22 VA.R. 3275-3297	7/1/98 - 6/30/99
12 VAC 30-70-440	Repealed	14:15 VA.R. 2248	6/1/98
12 VAC 30-70-441	Added	14:15 VA.R. 2248	6/1/98
12 VAC 30-80-30	Amended	14:12 VA.R. 1933	4/1/98
12 VAC 30-80-30	Amended	14:18 VA.R. 2582	7/1/98
12 VAC 30-80-170 emer	Amended	14:22 VA.R. 3299	7/1/98 - 6/30/99
12 VAC 30-90-52	Amended	14:22 VA.R. 3220	8/19/98
12 VAC 30-90-264	Amended	14:26 VA.R. 4261	10/15/98
12 VAC 30-90-266	Added	14:22 VA.R. 3220	8/19/98
12 VAC 30-90-290	Amended	14:26 VA.R. 4264	10/15/98
12 VAC 30-90-330	Added	14:22 VA.R. 3221	8/19/98
12 VAC 30-100-120	Amended	14:18 VA.R. 2583	7/1/98
12 VAC 30-100-400	Added	14:25 VA.R. 4070	10/1/98
12 VAC 30-100-410	Added	14:25 VA.R. 4070	10/1/98
12 VAC 30-100-420*	Added	14:25 VA.R. 4071	--
12 VAC 30-100-430	Added	14:25 VA.R. 4074	10/1/98
12 VAC 30-100-440	Added	14:25 VA.R. 4074	10/1/98
12 VAC 30-100-450	Added	14:25 VA.R. 4075	10/1/98
12 VAC 30-100-460	Added	14:25 VA.R. 4075	10/1/98
12 VAC 30-100-470	Added	14:25 VA.R. 4075	10/1/98
12 VAC 30-100-480	Added	14:25 VA.R. 4076	10/1/98
12 VAC 30-100-490	Added	14:25 VA.R. 4076	10/1/98
12 VAC 30-120-360	Amended	14:18 VA.R. 2584	7/1/98
12 VAC 30-120-360 emer	Amended	14:22 VA.R. 3300	7/1/98 - 6/30/99

* 12 VAC 30-100-420 was temporarily withdrawn (see 15:2 VA.R. 177 October 12, 1998)

Cumulative Table of VAC Sections Adopted, Amended, or Repealed

SECTION NUMBER	ACTION	CITE	EFFECTIVE DATE
12 VAC 30-120-370	Amended	14:18 VA.R. 2585	7/1/98
12 VAC 30-120-370 emer	Amended	14:22 VA.R. 3301	7/1/98 - 6/30/99
12 VAC 30-120-385	Added	14:18 VA.R. 2587	7/1/98
12 VAC 30-120-410	Amended	14:18 VA.R. 2587	7/1/98
12 VAC 30-120-420	Amended	14:18 VA.R. 2587	7/1/98
12 VAC 30-120-490 through 12 VAC 30-120-550	Added	14:18 VA.R. 2590	7/1/98
Title 13. Housing			
13 VAC 5-51-135 emer	Added	14:18 VA.R. 2605	4/27/98 - 4/26/99
13 VAC 5-61-440	Amended	14:18 VA.R. 2600	7/1/98
13 VAC 5-111-10	Amended	14:24 VA.R. 3943	9/17/98
13 VAC 5-111-60	Amended	14:24 VA.R. 3947	9/17/98
13 VAC 5-111-85	Amended	14:24 VA.R. 3947	9/17/98
13 VAC 5-111-150	Amended	14:24 VA.R. 3947	9/17/98
13 VAC 5-111-170	Amended	14:24 VA.R. 3948	9/17/98
13 VAC 5-111-335	Added	14:24 VA.R. 3948	9/17/98
13 VAC 10-10-20	Amended	14:17 VA.R. 2466	5/1/98
13 VAC 10-20-20	Amended	14:17 VA.R. 2467	5/1/98
13 VAC 10-40-100	Amended	14:11 VA.R. 1838	1/28/98
13 VAC 10-40-110	Amended	14:11 VA.R. 1839	1/28/98
13 VAC 10-40-120	Amended	14:11 VA.R. 1839	1/28/98
13 VAC 10-40-130	Amended	14:11 VA.R. 1839	1/28/98
13 VAC 10-40-140	Amended	14:11 VA.R. 1841	1/28/98
13 VAC 10-40-190	Amended	14:11 VA.R. 1842	1/28/98
13 VAC 10-40-210	Amended	14:11 VA.R. 1843	1/28/98
13 VAC 10-40-230	Added	14:11 VA.R. 1843	1/28/98
13 VAC 10-130-30	Amended	14:17 VA.R. 2468	5/1/98
13 VAC 10-140-20	Amended	14:17 VA.R. 2469	5/1/98
13 VAC 10-180-50	Amended	14:14 VA.R. 2141	3/4/98
13 VAC 10-180-60	Amended	14:14 VA.R. 2142	3/4/98
Title 14. Insurance			
14 VAC 5-395-10	Amended	14:26 VA.R. 4266	8/20/98
14 VAC 5-395-30	Amended	14:26 VA.R. 4266	8/20/98
14 VAC 5-395-50	Amended	14:26 VA.R. 4267	8/20/98
Title 16. Labor and Employment			
16 VAC 10-20-10	Amended	14:20 VA.R. 2759	7/1/98
16 VAC 10-20-20	Amended	14:20 VA.R. 2760	7/1/98
16 VAC 10-20-30	Amended	14:20 VA.R. 2760	7/1/98
16 VAC 10-20-40	Amended	14:20 VA.R. 2760	7/1/98
16 VAC 10-20-50	Repealed	14:20 VA.R. 2760	7/1/98
16 VAC 10-20-60	Repealed	14:20 VA.R. 2760	7/1/98
16 VAC 10-20-70	Repealed	14:20 VA.R. 2760	7/1/98
16 VAC 10-20-80	Amended	14:20 VA.R. 2760	7/1/98
16 VAC 10-20-90	Repealed	14:20 VA.R. 2761	7/1/98
16 VAC 10-20-100	Repealed	14:20 VA.R. 2761	7/1/98
16 VAC 10-20-110	Amended	14:20 VA.R. 2761	7/1/98
16 VAC 10-20-140	Amended	14:20 VA.R. 2761	7/1/98
16 VAC 10-20-150	Amended	14:20 VA.R. 2761	7/1/98
16 VAC 10-20-160	Amended	14:20 VA.R. 2761	7/1/98
16 VAC 10-20-170	Amended	14:20 VA.R. 2762	7/1/98
16 VAC 10-20-180	Repealed	14:20 VA.R. 2762	7/1/98
16 VAC 10-20-190	Amended	14:20 VA.R. 2762	7/1/98
16 VAC 10-20-200	Amended	14:20 VA.R. 2762	7/1/98
16 VAC 10-20-210	Repealed	14:20 VA.R. 2763	7/1/98
16 VAC 10-20-220	Repealed	14:20 VA.R. 2763	7/1/98

Cumulative Table of VAC Sections Adopted, Amended, or Repealed

SECTION NUMBER	ACTION	CITE	EFFECTIVE DATE
16 VAC 10-20-230	Repealed	14:20 VA.R. 2764	7/1/98
16 VAC 10-20-240	Amended	14:20 VA.R. 2764	7/1/98
16 VAC 10-20-250	Repealed	14:20 VA.R. 2765	7/1/98
16 VAC 10-20-260	Repealed	14:20 VA.R. 2765	7/1/98
16 VAC 10-20-270	Repealed	14:20 VA.R. 2766	7/1/98
16 VAC 10-20-275	Added	14:20 VA.R. 2766	7/1/98
16 VAC 10-20-280	Amended	14:20 VA.R. 2766	7/1/98
16 VAC 10-20-290	Repealed	14:20 VA.R. 2766	7/1/98
16 VAC 10-20-300	Amended	14:20 VA.R. 2766	7/1/98
16 VAC 10-20-310 through 16 VAC 10-20-460	Repealed	14:20 VA.R. 2767-2770	7/1/98
16 VAC 25-90-1910.94	Amended	14:15 VA.R. 2250	6/1/98
16 VAC 25-90-1910.111	Amended	14:15 VA.R. 2250	6/1/98
16 VAC 25-90-1910.134	Amended	14:15 VA.R. 2250	6/1/98
16 VAC 25-90-1910.134	Amended	14:22 VA.R. 3222	9/1/98
16 VAC 25-90-1910.139	Added	14:15 VA.R. 2250	6/1/98
16 VAC 25-90-1910.156	Amended	14:15 VA.R. 2250	6/1/98
16 VAC 25-90-1910.252	Amended	14:15 VA.R. 2250	6/1/98
16 VAC 25-90-1910.261	Erratum	14:17 VA.R. 2477	6/1/98
16 VAC 25-90-1910.1001	Amended	14:15 VA.R. 2250	6/1/98
16 VAC 25-90-1910.1003	Amended	14:15 VA.R. 2250	6/1/98
16 VAC 25-90-1910.1003	Amended	14:22 VA.R. 3222	9/1/98
16 VAC 25-90-1910.1017	Amended	14:15 VA.R. 2250	6/1/98
16 VAC 25-90-1910.1018	Amended	14:15 VA.R. 2250	6/1/98
16 VAC 25-90-1910.1025	Amended	14:15 VA.R. 2250	6/1/98
16 VAC 25-90-1910.1025	Amended	14:22 VA.R. 3222	9/1/98
16 VAC 25-90-1910.1027	Amended	14:15 VA.R. 2250	6/1/98
16 VAC 25-90-1910.1028	Amended	14:15 VA.R. 2250	6/1/98
16 VAC 25-90-1910.1028	Amended	14:22 VA.R. 3222	9/1/98
16 VAC 25-90-1910.1029	Amended	14:15 VA.R. 2250	6/1/98
16 VAC 25-90-1910.1043	Amended	14:15 VA.R. 2250	6/1/98
16 VAC 25-90-1910.1044	Amended	14:15 VA.R. 2250	6/1/98
16 VAC 25-90-1910.1045	Amended	14:15 VA.R. 2250	6/1/98
16 VAC 25-90-1910.1045	Amended	14:22 VA.R. 3222	9/1/98
16 VAC 25-90-1910.1047	Amended	14:15 VA.R. 2250	6/1/98
16 VAC 25-90-1910.1048	Amended	14:15 VA.R. 2250	6/1/98
16 VAC 25-90-1910.1048	Amended	14:22 VA.R. 3222	9/1/98
16 VAC 25-90-1910.1050	Amended	14:15 VA.R. 2250	6/1/98
16 VAC 25-90-1910.1050	Amended	14:22 VA.R. 3222	9/1/98
16 VAC 25-90-1910.1051	Amended	14:15 VA.R. 2250	6/1/98
16 VAC 25-90-1910.1052	Amended	14:14 VA.R. 2151	5/1/98
16 VAC 25-90-1910.1052	Amended	14:15 VA.R. 2250	6/1/98
16 VAC 25-90-1910.1052	Amended	14:22 VA.R. 3222	9/1/98
16 VAC 25-175-1926.1101	Amended	14:22 VA.R. 3222	9/1/98
Title 18. Professional and Occupational Licensing			
18 VAC 25-21-70	Amended	14:11 VA.R. 1845	4/1/98
18 VAC 30-20-10	Amended	14:14 VA.R. 2155	4/29/98
18 VAC 30-20-20	Repealed	14:14 VA.R. 2156	4/29/98
18 VAC 30-20-30	Repealed	14:14 VA.R. 2156	4/29/98
18 VAC 30-20-40	Repealed	14:14 VA.R. 2156	4/29/98
18 VAC 30-20-45	Added	14:14 VA.R. 2156	4/29/98
18 VAC 30-20-50	Amended	14:14 VA.R. 2156	4/29/98
18 VAC 30-20-60	Repealed	14:14 VA.R. 2156	4/29/98
18 VAC 30-20-70	Amended	14:14 VA.R. 2156	4/29/98
18 VAC 30-20-80	Amended	14:14 VA.R. 2157	4/29/98

Cumulative Table of VAC Sections Adopted, Amended, or Repealed

SECTION NUMBER	ACTION	CITE	EFFECTIVE DATE
18 VAC 30-20-90	Repealed	14:14 VA.R. 2157	4/29/98
18 VAC 30-20-100	Repealed	14:14 VA.R. 2157	4/29/98
18 VAC 30-20-110	Repealed	14:14 VA.R. 2157	4/29/98
18 VAC 30-20-120	Repealed	14:14 VA.R. 2157	4/29/98
18 VAC 30-20-130	Repealed	14:14 VA.R. 2157	4/29/98
18 VAC 30-20-140	Repealed	14:14 VA.R. 2157	4/29/98
18 VAC 30-20-150	Amended	14:14 VA.R. 2157	4/29/98
18 VAC 30-20-160	Amended	14:14 VA.R. 2157	4/29/98
18 VAC 30-20-170	Amended	14:14 VA.R. 2157	4/29/98
18 VAC 30-20-180	Amended	14:14 VA.R. 2159	4/29/98
18 VAC 30-20-190	Repealed	14:14 VA.R. 2159	4/29/98
18 VAC 30-20-200	Repealed	14:14 VA.R. 2159	4/29/98
18 VAC 30-20-210	Repealed	14:14 VA.R. 2159	4/29/98
18 VAC 30-20-220	Repealed	14:14 VA.R. 2159	4/29/98
18 VAC 30-20-240	Amended	14:14 VA.R. 2159	4/29/98
18 VAC 30-20-250	Repealed	14:14 VA.R. 2160	4/29/98
18 VAC 30-20-260	Repealed	14:14 VA.R. 2160	4/29/98
18 VAC 30-20-270	Repealed	14:14 VA.R. 2160	4/29/98
18 VAC 30-20-280	Amended	14:14 VA.R. 2160	4/29/98
18 VAC 60-20-105	Added	14:18 VA.R. 2602	6/24/98
18 VAC 76-10-10	Amended	14:11 VA.R. 1845	1/22/98
18 VAC 85-20-10	Amended	14:21 VA.R. 2904	8/5/98
18 VAC 85-20-20	Amended	14:21 VA.R. 2904	8/5/98
18 VAC 85-20-21	Added	14:21 VA.R. 2904	8/5/98
18 VAC 85-20-22	Added	14:21 VA.R. 2904	8/5/98
18 VAC 85-20-30	Amended	14:21 VA.R. 2905	8/5/98
18 VAC 85-20-60	Repealed	14:21 VA.R. 2905	8/5/98
18 VAC 85-20-70	Repealed	14:21 VA.R. 2905	8/5/98
18 VAC 85-20-105	Added	14:21 VA.R. 2905	8/5/98
18 VAC 85-20-110	Repealed	14:21 VA.R. 2905	8/5/98
18 VAC 85-20-120	Amended	14:21 VA.R. 2905	8/5/98
18 VAC 85-20-121	Added	14:21 VA.R. 2906	8/5/98
18 VAC 85-20-122	Added	14:21 VA.R. 2906	8/5/98
18 VAC 85-20-131	Added	14:21 VA.R. 2908	8/5/98
18 VAC 85-20-140	Amended	14:21 VA.R. 2908	8/5/98
18 VAC 85-20-150	Amended	14:21 VA.R. 2909	8/5/98
18 VAC 85-20-160	Repealed	14:21 VA.R. 2909	8/5/98
18 VAC 85-20-170	Repealed	14:21 VA.R. 2910	8/5/98
18 VAC 85-20-180	Repealed	14:21 VA.R. 2910	8/5/98
18 VAC 85-20-190	Repealed	14:21 VA.R. 2911	8/5/98
18 VAC 85-20-200	Repealed	14:21 VA.R. 2911	8/5/98
18 VAC 85-20-210	Amended	14:21 VA.R. 2912	8/5/98
18 VAC 85-20-230	Amended	14:21 VA.R. 2912	8/5/98
18 VAC 85-20-240	Amended	14:21 VA.R. 2912	8/5/98
18 VAC 85-20-250	Repealed	14:21 VA.R. 2912	8/5/98
18 VAC 85-20-260	Repealed	14:21 VA.R. 2913	8/5/98
18 VAC 85-20-270	Repealed	14:21 VA.R. 2913	8/5/98
18 VAC 85-40-10	Amended	14:21 VA.R. 2915	8/5/98
18 VAC 85-40-20	Amended	14:21 VA.R. 2915	8/5/98
18 VAC 85-40-40	Amended	14:21 VA.R. 2915	8/5/98
18 VAC 85-40-50	Amended	14:21 VA.R. 2916	8/5/98
18 VAC 85-40-60	Amended	14:21 VA.R. 2916	8/5/98
18 VAC 85-40-70	Amended	14:21 VA.R. 2916	8/5/98
18 VAC 85-40-80	Amended	14:21 VA.R. 2916	8/5/98
18 VAC 85-50-10	Amended	14:21 VA.R. 2923	8/5/98

Cumulative Table of VAC Sections Adopted, Amended, or Repealed

SECTION NUMBER	ACTION	CITE	EFFECTIVE DATE
18 VAC 85-50-50	Amended	14:21 VA.R. 2924	8/5/98
18 VAC 85-50-55	Amended	14:21 VA.R. 2924	8/5/98
18 VAC 85-50-57	Amended	14:21 VA.R. 2924	8/5/98
18 VAC 85-50-101	Added	14:21 VA.R. 2924	8/5/98
18 VAC 85-50-115	Amended	14:21 VA.R. 2925	8/5/98
18 VAC 85-50-116	Added	14:21 VA.R. 2925	8/5/98
18 VAC 85-50-170	Amended	14:21 VA.R. 2925	8/5/98
18 VAC 85-80-10	Amended	14:21 VA.R. 2934	8/5/98
18 VAC 85-80-40	Amended	14:21 VA.R. 2934	8/5/98
18 VAC 85-80-50	Amended	14:21 VA.R. 2934	8/5/98
18 VAC 85-80-60	Amended	14:21 VA.R. 2935	8/5/98
18 VAC 85-80-70	Amended	14:21 VA.R. 2935	8/5/98
18 VAC 85-80-80	Amended	14:21 VA.R. 2935	8/5/98
18 VAC 85-80-120	Amended	14:21 VA.R. 2935	8/5/98
18 VAC 110-20-210	Amended	14:15 VA.R. 2253	5/13/98
18 VAC 115-40-10	Amended	14:25 VA.R. 4076	9/30/98
18 VAC 115-40-20	Amended	14:25 VA.R. 4077	9/30/98
18 VAC 115-40-22	Amended	14:25 VA.R. 4077	9/30/98
18 VAC 115-40-25	Amended	14:25 VA.R. 4077	9/30/98
18 VAC 115-40-26	Added	14:25 VA.R. 4078	9/30/98
18 VAC 115-40-27	Added	14:25 VA.R. 4078	9/30/98
18 VAC 115-40-40	Amended	14:25 VA.R. 4078	9/30/98
18 VAC 115-40-50	Amended	14:25 VA.R. 4079	9/30/98
18 VAC 120-30-100	Amended	14:11 VA.R. 1846	4/1/98
18 VAC 120-40-10 through 18 VAC 120-40-430 emer	Added	14:25 VA.R. 4088	8/11/98 - 8/10/99
18 VAC 125-20-30	Amended	14:11 VA.R. 1851	4/1/98
18 VAC 135-20-10*	Amended	14:20 VA.R. 2771	*
18 VAC 135-20-20*	Amended	14:20 VA.R. 2771	*
18 VAC 135-20-30*	Amended	14:20 VA.R. 2772	*
18 VAC 135-20-40*	Amended	14:20 VA.R. 2773	*
18 VAC 135-20-45*	Added	14:20 VA.R. 2773	*
18 VAC 135-20-50*	Amended	14:20 VA.R. 2773	*
18 VAC 135-20-60*	Amended	14:20 VA.R. 2774	*
18 VAC 135-20-80*	Amended	14:20 VA.R. 2774	*
18 VAC 135-20-90*	Amended	14:20 VA.R. 2775	*
18 VAC 135-20-100*	Amended	14:20 VA.R. 2775	*
18 VAC 135-20-110*	Amended	14:20 VA.R. 2776	*
18 VAC 135-20-120*	Amended	14:20 VA.R. 2776	*
18 VAC 135-20-150*	Amended	14:20 VA.R. 2776	*
18 VAC 135-20-160*	Amended	14:20 VA.R. 2776	*
18 VAC 135-20-170*	Amended	14:20 VA.R. 2777	*
18 VAC 135-20-180*	Amended	14:20 VA.R. 2777	*
18 VAC 135-20-190*	Amended	14:20 VA.R. 2778	*
18 VAC 135-20-200*	Amended	14:20 VA.R. 2779	*
18 VAC 135-20-210*	Amended	14:20 VA.R. 2779	*
18 VAC 135-20-220*	Amended	14:20 VA.R. 2780	*
18 VAC 135-20-240*	Amended	14:20 VA.R. 2780	*
18 VAC 135-20-250*	Amended	14:20 VA.R. 2780	*
18 VAC 135-20-260*	Amended	14:20 VA.R. 2780	*
18 VAC 135-20-270*	Amended	14:20 VA.R. 2781	*
18 VAC 135-20-280*	Amended	14:20 VA.R. 2781	*
18 VAC 135-20-290*	Amended	14:20 VA.R. 2781	*

* The regulatory process was suspended on this section in 14:24 VA.R. 3949, and the final effective date will be delayed.

Cumulative Table of VAC Sections Adopted, Amended, or Repealed

SECTION NUMBER	ACTION	CITE	EFFECTIVE DATE
18 VAC 135-20-300*	Amended	14:20 VA.R. 2782	*
18 VAC 135-20-310*	Amended	14:20 VA.R. 2782	*
18 VAC 135-20-320*	Amended	14:20 VA.R. 2783	*
18 VAC 135-20-350*	Amended	14:20 VA.R. 2783	*
18 VAC 135-20-360*	Amended	14:20 VA.R. 2783	*
18 VAC 135-20-370*	Amended	14:20 VA.R. 2784	*
18 VAC 135-20-380*	Amended	14:20 VA.R. 2784	*
18 VAC 135-20-390*	Amended	14:20 VA.R. 2784	*
18 VAC 135-20-400*	Amended	14:20 VA.R. 2785	*
18 VAC 135-20-410*	Amended	14:20 VA.R. 2785	*
18 VAC 135-20-420*	Repealed	14:20 VA.R. 2785	*
18 VAC 135-20-430*	Repealed	14:20 VA.R. 2785	*
18 VAC 135-20-440*	Repealed	14:20 VA.R. 2785	*
Title 19. Public Safety			
19 VAC 30-20-10	Amended	14:11 VA.R. 1853	3/18/98
19 VAC 30-20-70	Amended	14:11 VA.R. 1853	3/18/98
19 VAC 30-20-80	Amended	14:11 VA.R. 1854	3/18/98
19 VAC 30-20-140	Amended	14:11 VA.R. 1854	3/18/98
19 VAC 30-20-150	Amended	14:11 VA.R. 1854	3/18/98
19 VAC 30-20-160	Amended	14:11 VA.R. 1854	3/18/98
19 VAC 30-170-05	Added	14:22 VA.R. 3225	7/1/98
19 VAC 30-170-10	Amended	14:22 VA.R. 3225	7/1/98
19 VAC 30-170-20	Amended	14:22 VA.R. 3225	7/1/98
19 VAC 30-170-30	Amended	14:22 VA.R. 3226	7/1/98
19 VAC 30-170-40	Amended	14:22 VA.R. 3227	7/1/98
19 VAC 30-170-50	Amended	14:22 VA.R. 3228	7/1/98
19 VAC 30-170-60	Added	14:22 VA.R. 3228	7/1/98
Title 20. Public Utilities and Telecommunications			
20 VAC 5-310-10	Amended	14:15 VA.R. 2253	3/24/98
Title 21. Securities and Retail Franchising			
21 VAC 5-10-40	Amended	14:22 VA.R. 3240	7/1/98
21 VAC 5-20-10	Amended	14:22 VA.R. 3240	7/1/98
21 VAC 5-20-70	Amended	14:22 VA.R. 3241	7/1/98
21 VAC 5-20-80	Amended	14:22 VA.R. 3241	7/1/98
21 VAC 5-20-230	Amended	14:22 VA.R. 3243	7/1/98
21 VAC 5-20-290	Amended	14:22 VA.R. 3243	7/1/98
21 VAC 5-20-300	Amended	14:22 VA.R. 3243	7/1/98
21 VAC 5-30-20	Amended	14:22 VA.R. 3244	7/1/98
21 VAC 5-30-50	Amended	14:22 VA.R. 3244	7/1/98
21 VAC 5-30-60	Amended	14:22 VA.R. 3244	7/1/98
21 VAC 5-30-70	Amended	14:22 VA.R. 3244	7/1/98
21 VAC 5-30-80	Amended	14:22 VA.R. 3245	7/1/98
21 VAC 5-40-20	Amended	14:22 VA.R. 3245	7/1/98
21 VAC 5-40-30	Amended	14:22 VA.R. 3246	7/1/98
21 VAC 5-40-100	Amended	14:22 VA.R. 3247	7/1/98
21 VAC 5-40-120	Amended	14:22 VA.R. 3249	7/1/98
21 VAC 5-80-10	Amended	14:22 VA.R. 3249	7/1/98
21 VAC 5-80-40	Amended	14:22 VA.R. 3250	7/1/98
21 VAC 5-80-140	Amended	14:22 VA.R. 3250	7/1/98
21 VAC 5-80-160	Amended	14:22 VA.R. 3251	7/1/98
21 VAC 5-80-170	Amended	14:22 VA.R. 3253	7/1/98
21 VAC 5-80-210	Amended	14:22 VA.R. 3253	7/1/98

* The regulatory process was suspended on this section in 14:24 VA.R. 3949, and the final effective date will be delayed.

Cumulative Table of VAC Sections Adopted, Amended, or Repealed

SECTION NUMBER	ACTION	CITE	EFFECTIVE DATE
21 VAC 5-80-220	Amended	14:22 VA.R. 3254	7/1/98
21 VAC 5-80-250	Added	14:22 VA.R. 3255	7/1/98
21 VAC 5-85-10	Amended	14:13 VA.R. 1976	2/17/98
21 VAC 5-85-10	Amended	14:15 VA.R. 2259	3/24/98
21 VAC 5-85-10	Amended	14:22 VA.R. 3256	7/1/98
21 VAC 5-120-10 through 21 VAC 5-120-110	Added	14:22 VA.R. 3261-3264	7/1/98
Title 22. Social Services			
22 VAC 15-30-10	Amended	14:21 VA.R. 2942	9/1/98
22 VAC 15-30-20	Amended	14:21 VA.R. 2946	9/1/98
22 VAC 15-30-30	Amended	14:21 VA.R. 2946	9/1/98
22 VAC 15-30-40	Repealed	14:21 VA.R. 2946	9/1/98
22 VAC 15-30-50	Amended	14:21 VA.R. 2946	9/1/98
22 VAC 15-30-60	Repealed	14:21 VA.R. 2947	9/1/98
22 VAC 15-30-70	Amended	14:21 VA.R. 2948	9/1/98
22 VAC 15-30-80	Amended	14:21 VA.R. 2948	9/1/98
22 VAC 15-30-90	Amended	14:21 VA.R. 2948	9/1/98
22 VAC 15-30-100	Amended	14:21 VA.R. 2949	9/1/98
22 VAC 15-30-110	Amended	14:21 VA.R. 2949	9/1/98
22 VAC 15-30-120	Amended	14:21 VA.R. 2949	9/1/98
22 VAC 15-30-130	Amended	14:21 VA.R. 2950	9/1/98
22 VAC 15-30-140	Amended	14:21 VA.R. 2950	9/1/98
22 VAC 15-30-150	Amended	14:21 VA.R. 2950	9/1/98
22 VAC 15-30-160	Amended	14:21 VA.R. 2950	9/1/98
22 VAC 15-30-170	Amended	14:21 VA.R. 2951	9/1/98
22 VAC 15-30-180	Amended	14:21 VA.R. 2951	9/1/98
22 VAC 15-30-190	Amended	14:21 VA.R. 2952	9/1/98
22 VAC 15-30-200	Amended	14:21 VA.R. 2952	9/1/98
22 VAC 15-30-210	Repealed	14:21 VA.R. 2952	9/1/98
22 VAC 15-30-220	Repealed	14:21 VA.R. 2952	9/1/98
22 VAC 15-30-230	Amended	14:21 VA.R. 2953	9/1/98
22 VAC 15-30-240	Repealed	14:21 VA.R. 2953	9/1/98
22 VAC 15-30-250	Amended	14:21 VA.R. 2954	9/1/98
22 VAC 15-30-260	Amended	14:21 VA.R. 2954	9/1/98
22 VAC 15-30-270	Repealed	14:21 VA.R. 2955	9/1/98
22 VAC 15-30-280	Amended	14:21 VA.R. 2955	9/1/98
22 VAC 15-30-290	Amended	14:21 VA.R. 2955	9/1/98
22 VAC 15-30-300	Repealed	14:21 VA.R. 2955	9/1/98
22 VAC 15-30-310	Amended	14:21 VA.R. 2955	9/1/98
22 VAC 15-30-320	Amended	14:21 VA.R. 2956	9/1/98
22 VAC 15-30-330	Amended	14:21 VA.R. 2957	9/1/98
22 VAC 15-30-340	Amended	14:21 VA.R. 2958	9/1/98
22 VAC 15-30-350	Amended	14:21 VA.R. 2958	9/1/98
22 VAC 15-30-360	Amended	14:21 VA.R. 2959	9/1/98
22 VAC 15-30-370	Amended	14:21 VA.R. 2959	9/1/98
22 VAC 15-30-380	Amended	14:21 VA.R. 2959	9/1/98
22 VAC 15-30-390	Amended	14:21 VA.R. 2960	9/1/98
22 VAC 15-30-400	Repealed	14:21 VA.R. 2960	9/1/98
22 VAC 15-30-410	Amended	14:21 VA.R. 2961	9/1/98
22 VAC 15-30-420	Repealed	14:21 VA.R. 2961	9/1/98
22 VAC 15-30-430	Amended	14:21 VA.R. 2961	9/1/98
22 VAC 15-30-440	Amended	14:21 VA.R. 2962	9/1/98
22 VAC 15-30-450	Repealed	14:21 VA.R. 2963	9/1/98
22 VAC 15-30-451	Added	14:21 VA.R. 2965	9/1/98
22 VAC 15-30-460	Repealed	14:21 VA.R. 2963	9/1/98

Cumulative Table of VAC Sections Adopted, Amended, or Repealed

SECTION NUMBER	ACTION	CITE	EFFECTIVE DATE
22 VAC 15-30-461	Added	14:21 VA.R. 2965	9/1/98
22 VAC 15-30-470	Repealed	14:21 VA.R. 2964	9/1/98
22 VAC 15-30-471	Added	14:21 VA.R. 2966	9/1/98
22 VAC 15-30-480	Repealed	14:21 VA.R. 2964	9/1/98
22 VAC 15-30-481	Added	14:21 VA.R. 2966	9/1/98
22 VAC 15-30-484	Added	14:21 VA.R. 2966	9/1/98
22 VAC 15-30-487	Added	14:21 VA.R. 2966	9/1/98
22 VAC 15-30-490	Amended	14:21 VA.R. 2966	9/1/98
22 VAC 15-30-500	Amended	14:21 VA.R. 2967	9/1/98
22 VAC 15-30-510	Amended	14:21 VA.R. 2968	9/1/98
22 VAC 15-30-520	Amended	14:21 VA.R. 2968	9/1/98
22 VAC 15-30-530	Repealed	14:21 VA.R. 2969	9/1/98
22 VAC 15-30-540	Amended	14:21 VA.R. 2969	9/1/98
22 VAC 15-30-550	Amended	14:21 VA.R. 2969	9/1/98
22 VAC 15-30-560	Amended	14:21 VA.R. 2970	9/1/98
22 VAC 15-30-570	Amended	14:21 VA.R. 2970	9/1/98
22 VAC 15-30-575	Added	14:21 VA.R. 2970	9/1/98
22 VAC 15-30-580	Amended	14:21 VA.R. 2971	9/1/98
22 VAC 15-30-590	Amended	14:21 VA.R. 2971	9/1/98
22 VAC 15-30-600	Amended	14:21 VA.R. 2972	9/1/98
22 VAC 15-30-610	Amended	14:21 VA.R. 2972	9/1/98
22 VAC 15-30-620	Amended	14:21 VA.R. 2973	9/1/98
22 VAC 15-30-630	Amended	14:21 VA.R. 2973	9/1/98
22 VAC 15-30-640	Amended	14:21 VA.R. 2974	9/1/98
22 VAC 15-30-650	Amended	14:21 VA.R. 2975	9/1/98
22 VAC 15-30-660	Amended	14:21 VA.R. 2975	9/1/98
22 VAC 15-30-670	Amended	14:21 VA.R. 2975	9/1/98
22 VAC 15-30-680	Repealed	14:21 VA.R. 2976	9/1/98
22 VAC 15-30-690	Repealed	14:21 VA.R. 2976	9/1/98
22 VAC 15-30-700	Repealed	14:21 VA.R. 2977	9/1/98
22 VAC 15-30-710	Repealed	14:21 VA.R. 2977	9/1/98
22 VAC 15-30-720	Repealed	14:21 VA.R. 2978	9/1/98
22 VAC 15-30-730	Repealed	14:21 VA.R. 2978	9/1/98
22 VAC 15-40-10 through 22 VAC 15-40-730	Repealed	14:21 VA.R. 2990	9/1/98
Title 24. Transportation and Motor Vehicles			
24 VAC 22-30-20	Amended	14:24 VA.R. 3949	10/1/98
24 VAC 22-30-30	Amended	14:24 VA.R. 3950	10/1/98
24 VAC 30-71-10	Amended	14:23 VA.R. 3633	9/3/98
24 VAC 30-71-80	Amended	14:23 VA.R. 3634	9/3/98
24 VAC 30-71-130	Amended	14:23 VA.R. 3634	9/3/98
24 VAC 30-71-160	Erratum	14:13 VA.R. 2011	--
24 VAC 30-71-170	Erratum	14:13 VA.R. 2028	--
24 VAC 30-170-10	Amended	14:13 VA.R. 1992	4/15/98
24 VAC 30-200-10	Amended	14:26 VA.R. 4267	10/14/98
24 VAC 30-200-10	Erratum	15:1 VA.R. 50 (4396)	--
24 VAC 30-200-20	Amended	14:26 VA.R. 4268	10/14/98
24 VAC 30-200-30	Amended	14:26 VA.R. 4269	10/14/98
24 VAC 30-200-40	Added	14:26 VA.R. 4270	10/14/98
24 VAC 30-200-40	Erratum	15:1 VA.R. 50	--
24 VAC 30-350-10	Amended	14:23 VA.R. 3635	7/14/98
24 VAC 30-380-10	Amended	14:13 VA.R. 1992	2/24/98
24 VAC 30-390-10	Amended	14:13 VA.R. 1992	2/24/98
24 VAC 30-620-30	Amended	14:25 VA.R. 4086	9/30/98

NOTICES OF INTENDED REGULATORY ACTION

Symbol Key

† Indicates entries since last publication of the *Virginia Register*

TITLE 8. EDUCATION

STATE BOARD OF EDUCATION

Notice of Intended Regulatory Action

Notice is hereby given in accordance with § 9-6.14:7.1 of the Code of Virginia that the State Board of Education intends to consider amending regulations entitled: **8 VAC 20-131-10 et seq. Regulations Establishing Standards for Accrediting Public Schools in Virginia.** The purpose of the proposed action is to incorporate new language as required by § 22.1-253.13:4 F of the Code of Virginia (enacted by the 1998 Session of the General Assembly) which requires the State Board of Education to develop criteria for recognizing exemplary performance in vocational studies by students who have completed the requirements for a standard or advanced studies diploma and to award seals on the diploma of students meeting such criteria. The agency intends to hold a public hearing on the proposed action after publication.

Statutory Authority: §§ 22.1-16, 22.1-19 and 22.1-253.13:3 of the Code of Virginia.

Public comments may be submitted until October 28, 1998.

Contact: Charles Finley, Director, Division of Compliance, Department of Education, P.O. Box 2120, Richmond, VA 23218-2120, telephone (804) 225-2092 or FAX (804) 225-2053.

VA.R. Doc. No. R99-17; Filed September 9, 1998, 10:46 a.m.

TITLE 9. ENVIRONMENT

STATE WATER CONTROL BOARD

Notice of Intended Regulatory Action

Notice is hereby given in accordance with § 9-6.14:7.1 of the Code of Virginia that the State Water Control Board intends to consider amending regulations entitled: **9 VAC 25-260-10 et seq. Water Quality Standards.** The purpose of the proposed action is to consider whether the board should amend the Upper James River Basin section tables to correct the stream classification of a small section of the Jackson River in Alleghany County. The rulemaking, if adopted, will correctly classify the section from a Class V, stockable trout water, to a Class IV, mountainous zone water. The Department of Game and Inland Fisheries

(DGIF) has informed the department that the amendment classifying the section as a stockable trout water which became effective in December 1997 is incorrect.

Intent: The intent of the amendment is to protect the aquatic life expected to inhabit the Jackson River.

Need: The amendment is necessary in order to correctly classify the stream to protect the aquatic life which is expected to inhabit the stream and ensure that Westvaco's point source discharges to the stream are not required to install additional treatment capability.

Alternatives Available to Meet the Need: Water quality standards are regulations; therefore, a regulatory action is necessary to meet the need of the intended regulatory action based on DGIF advising the department that the current regulatory classification is incorrect. There may be options as to the specific designation of stockable trout water, if any, within this stretch of the Jackson River. These will be developed in conjunction with the DGIF based on their technical data on the designation and public comment received in response to this notice.

Comments: Comments are requested on the intended regulatory action, including any ideas to assist the department in the development of the proposal. Comments are also requested on the costs and benefits of the stated alternatives or other alternatives.

Participatory Approach and Public Meeting: The State Water Control Board has authorized the department to develop the proposed regulation without using the participatory approach and without holding a public meeting.

Public Hearing: The State Water Control Board will convene a public hearing on the proposed regulation after publication of the proposal. This has not been scheduled yet.

Statutory Authority: § 62.1-44.15 (3a) of the Code of Virginia.

Public comments may be submitted until October 14, 1998, to Dr. Alan J. Anthony, Department of Environmental Quality, P.O. Box 10009, Richmond, VA 23240.

Contact: Eleanore Daub, Department of Environmental Quality, P.O. Box 10009, Richmond, VA 23240, telephone (804) 698-4111.

VA.R. Doc. No. R98-322; Filed August 26, 1998, 7:45 a.m.

† Notice of Intended Regulatory Action

Notice is hereby given in accordance with § 9-6.14:7.1 of the Code of Virginia that the State Water Control Board intends to consider amending regulations entitled: **9 VAC 25-260-350. Water Quality Standards: Designation of Nutrient Enriched Waters.** The purpose of the proposed action is to

Notices of Intended Regulatory Action

consider whether the board should amend the regulation to designate Stony Creek in Shenandoah County as a nutrient enriched water.

Intent: This designation could have a significant impact on both point and nonpoint source activities in the watershed of this creek and the department intends to provide the public every avenue of public participation, beginning with this Notice of Intended Regulatory Action, in order to ensure the amendment is necessary to protect aquatic life and human health and provide for the maintenance of water quality in the Commonwealth of Virginia.

Need: The department's evaluation of agency in-stream nutrient monitoring data for Stony Creek for the period of July 6, 1994, through May 6, 1997, indicates nutrient enriched conditions. Consequently, the department proposes that the watershed (Stony Creek and its tributaries) qualifies for regulatory designation as a nutrient enriched water. The basis for this determination was monitoring data for total phosphorus, which is one of three indicators of nutrient enrichment used for regulatory designation of waters as nutrient enriched.

If the water is designated nutrient enriched, a companion regulation, the board's Policy for Nutrient Enriched Waters (9 VAC 25-40-10 et seq.) requires certain municipal and industrial dischargers with a design flow of 1.0 MGD or greater and effluents containing phosphorus to maintain a monthly average total phosphorus concentration of 2 milligrams per liter (mg/l) or less. Rocco Farm Foods near Edinburg - based on a flow of 1.005 MGD - would be the only point source discharger impacted by this regulatory requirement to install a phosphorus removal system to control total phosphorus. The other three point source dischargers in the watershed, Stony Creek Sanitary District, Shrine Mont, and Edinburg Sewage Treatment Plant, have design flows below that covered in the policy and thus would not be required to install phosphorus controls.

If Stony Creek is designated a nutrient enriched water, the Department of Conservation and Recreation would be required to target control measures for nonpoint source nutrient inputs.

Alternatives Available to Meet the Need: In compliance with the State Water Control Board's Public Participation Guidelines, 9 VAC 25-10-10 et seq., the department will consider all alternatives which are considered to be less burdensome and less intrusive for achieving the essential purpose of the proposed regulation and any other alternatives presented during the proposed rulemaking. Several alternatives have already been considered. One alternative was to leave the regulation unchanged. This may appear to be the least intrusive approach; however, such an alternative would not provide a control strategy for the potential water quality degradation in Stony Creek from a documented excess of phosphorus. There may be other less intrusive alternatives to consider. For example, other alternatives would be to designate only the mainstem or a portion of the mainstem of Stony Creek as a nutrient enriched water.

Request for Comments: Comments are requested on the intended regulatory action, to include any ideas to assist the department in the development of the proposal. Comments are requested on the costs and benefits of the stated alternatives or other alternatives. The Department of Environmental Quality also requests comments as to whether the department should use the participatory approach to assist in the development of the proposal. The participatory approach is defined as a method for the use of (i) standing advisory committees, (ii) ad hoc advisory groups or panels, (iii) consultation with groups or individuals registering interest in working with the agency, or (iv) any combination thereof.

Public Meeting: A public meeting will be held on Tuesday, November 17, 1998, at 7 p.m. in the Shenandoah County Brick Building, 3rd Floor Courtroom, 112 South Main Street in Woodstock.

Statutory Authority: § 62.1-44.15 (3a) of the Code of Virginia.

Public comments may be submitted until November 20, 1998.

Contact: Jean Gregory, Department of Environmental Quality, P.O. Box 10009, Richmond, VA 23240, telephone (804) 698-4113 or toll-free 1-800-592-5482.

VA.R. Doc. No. R99-24; Filed September 23, 1998, 11:23 a.m.

TITLE 12. HEALTH

STATE BOARD OF HEALTH

† Notice of Intended Regulatory Action

Notice is hereby given in accordance with § 9-6.14:7.1 of the Code of Virginia that the State Board of Health intends to consider promulgating regulations entitled: **12 VAC 5-165-10 et seq. Regulations for the Repacking of Crab Meat.** The purpose of the proposed action is to adopt regulations establishing criteria by which the Virginia crab industry can safely repack both domestic and imported crab meat. Repacking involves the removal of crab meat picked and packed at another location and placing it in another container bearing the name of the local packer or distributor. Virginia is one of the leading blue crab producers in the nation and has established a reputation for a high quality, high value product. The proposed action may provide for the safety of consumers of crab meat processed in Virginia by (i) establishing minimum processing and shipping standards for the facility originally packing the product to be repacked in Virginia; (ii) establishing minimum product quality standards for crab meat to be repacked in Virginia; (iii) outlining procedures necessary to protect the product from contamination during processing in the Virginia facility; and (iv) establishing labeling and record keeping requirements necessary to maintain the source identity of the repacked

Notices of Intended Regulatory Action

product. The establishment of these regulations will help the Virginia crab industry to maintain a reputation as a producer of high quality products, which will result in a continuing high market value for these products. The proposed action may also address other issues relating to these regulations that the public, regulated persons, and the health planning community deem appropriate to raise in response to this notice. The agency does not intend to hold a public hearing on the proposed regulation after publication.

Statutory Authority: § 28.2-801 of the Code of Virginia.

Public comments may be submitted until November 13, 1998.

Contact: Keith Skiles, Program Manager, Department of Health, 1500 E. Main St., Room 109, Richmond, VA 23219, telephone (804) 786-7937 or FAX (804) 786-5567.

VA.R. Doc. No. R99-25; Filed September 23, 1998, 11:26 a.m.

† Notice of Intended Regulatory Action

Notice is hereby given in accordance with § 9-6.14:7.1 of the Code of Virginia that the State Board of Health intends to consider promulgating regulations entitled: **12 VAC 5-280-10 et seq. State Medical Facilities Plan: Organ Transplantation Services.** The purpose of the proposed action is to review and amend the regulations to ensure that the criteria used in review of proposed organ transplantation projects reflect the most current national experience in transplantation program performance. The organ transplantation services component of the State Medical Facilities Plan is intended to provide a rational basis for considering the public need for new or expanded organ transplantation services in Virginia. Organ transplantation is a highly specialized medical service which only a few large hospitals have or will seek to offer, based on the available technology. Resulting amendments may address other issues relating to these regulations that the public, regulants, and the health planning community deem appropriate to raise following this notice. The agency does not intend to hold a public hearing on the proposed regulation after publication.

Statutory Authority: §§ 32.1-12 and 32.1-102.1 et seq. of the Code of Virginia.

Public comments may be submitted until 5 p.m. on November 12, 1998, to Nancy R. Hofheimer, Director, Center for Quality Health Care Services and Consumer Protection, Department of Health, 3600 W. Broad St., Suite 216, Richmond, VA 23230, telephone (804) 367-2102 or FAX (804) 367-2149.

Contact: Carrie Eddy, Policy Analyst, Center for Quality Health Care and Consumer Protection, Department of Health, 3600 W. Broad St., Suite 216, Richmond, VA 23230, telephone (804) 367-2102 or FAX (804) 367-2149.

VA.R. Doc. No. R99-22; Filed September 21, 1998, 11:51 a.m.

Notice of Intended Regulatory Action

Notice is hereby given in accordance with § 9-6.14:7.1 of the Code of Virginia that the State Board of Health intends to consider promulgating regulations entitled: **12 VAC 5-408-10 et seq. Regulations for the Certification of Quality Assurance of Managed Care Health Insurance Plan Licensees.** The purpose of the proposed action is to implement Senate Bill 712 (1998) which establishes a quality assurance certification program for managed care health insurance plan (MCHIP) licensees. All MCHIP licensees will have to obtain certification and remain certified by the State Health Commissioner to confirm the quality of health care services they deliver. The regulation will define the expectations relating to quality upon which certification will be based. The agency intends to hold a public hearing on the proposed regulation after publication.

Statutory Authority: § 32.1-137.3 of the Code of Virginia.

Public comments may be submitted until 5 p.m. on October 28, 1998.

Contact: Carrie Eddy, Policy Analyst, Center for Quality Health Care and Consumer Protection, Department of Health, 3600 W. Broad St., Suite 216, Richmond, VA 23230, telephone (804) 367-2102 or FAX (804) 367-2149.

VA.R. Doc. No. R99-16; Filed September 9, 1998, 10:46 a.m.

Notice of Intended Regulatory Action

Notice is hereby given in accordance with § 9-6.14:7.1 of the Code of Virginia that the State Board of Health intends to consider amending regulations entitled: **12 VAC 5-520-10 et seq. Regulations Governing the State Dental Scholarship Program.** The purpose of the proposed action is to review the regulations and amend them to ensure the sound and orderly administration of the related program that awards conditional educational grants to dental students based on their agreement to practice dentistry in an area of the Commonwealth that is recognized by the board as being underserved by dentists. Resulting amendments may include provisions that (i) refine the criteria employed in awarding scholarships, (ii) require that the commencement of recipients' dental practice will occur within two years following the completion of their dental residency, and (iii) include an alternative method of reimbursing the Commonwealth for students who either fail to complete dental school or fail to satisfy their obligation to practice in an underserved area. Resulting amendments may also address other issues relating to these regulations that the public, regulants, and health planning community deem appropriate to raise. The agency does not intend to hold a public hearing on the proposed regulation after publication.

Statutory Authority: § 32.1-122.9 of the Code of Virginia.

Public comments may be submitted until October 16, 1998.

Contact: Dr. Karen Day, Director, Division of Dental Health, Department of Health, 1500 E. Main St., Room 136,

Notices of Intended Regulatory Action

Richmond, VA 23219, telephone (804) 786-3556, FAX (804) 371-4004 or toll-free 1-800-828-1120.

VA.R. Doc. No. R98-323; Filed August 26, 1998, 11:20 a.m.

† Notice of Intended Regulatory Action

Notice is hereby given in accordance with § 9-6.14:7.1 of the Code of Virginia that the State Board of Health intends to consider amending regulations entitled: **12 VAC 5-540-10 et seq. Rules and Regulations for the Identification of Medically Underserved Areas in Virginia.** The purpose of the proposed action is to review the regulations and amend them so as to ensure the accurate and appropriate identification of medically-underserved areas (MUAs) in Virginia. Certain geographic areas across Virginia need additional primary health care to serve local residents; the regulations set forth criteria for the identification and designation of these areas as MUAs. Persons who receive scholarships through the Virginia Medical Scholarship and Nurse Practitioner Scholarship programs agree to recompense the Commonwealth by practicing primary care medicine in these MUAs, where the demonstrated need for such services is greatest. MUAs may also become eligible for federal or state assistance, or both, in establishing primary care medical centers. Resulting amendments may clarify the criteria for identifying MUAs and related provisions, ensure consistency and uniformity, and incorporate a procedure for reviewing the designation of MUAs in Virginia. Resulting amendments may also address other issues relating to the regulations that the public, regulated persons, and the health planning community deem appropriate to raise following this notice. The agency does not intend to hold a public hearing on the proposed regulation after publication.

Statutory Authority: §§ 32.1-12 and 32.1-122.5 of the Code of Virginia.

Public comments may be submitted until November 13, 1998.

Contact: B. A. Caro-Justin, Program Coordinator, Department of Health, Center for Primary Care Resources Development, 1500 E. Main St., Room 227, Richmond, VA 23219, telephone (804) 786-4891, FAX (804) 371-0116 or toll-free 1-800-828-1120/TTY ☎.

VA.R. Doc. No. R99-23; Filed September 21, 1998, 11:51 a.m.

Notice of Intended Regulatory Action

Notice is hereby given in accordance with § 9-6.14:7.1 of the Code of Virginia that the State Board of Health intends to consider amending regulations entitled: **12 VAC 5-550-10 et seq. Board of Health Regulations Governing Vital Records.** The purpose of the proposed action is to review the regulations and amend them to ensure the accurate, uniform, efficient, and confidential administration of the Commonwealth's system for maintaining vital records, such as birth, adoption, marriage, divorce, death, and fetal death records, and for allowing necessary changes to these

records. Resulting amendments may (i) provide for the electronic reporting of births, (ii) allow delayed reporting of births when warranted, (iii) specify information needed to evidence home births, and (iv) establish protections against the unauthorized, unwarranted, and indiscriminate disclosure of vital records. Resulting amendments may also address other issues relating to these regulations that the public, regulated persons, and the health planning community deem appropriate to raise in response to this notice. The agency does not intend to hold a public hearing on the proposed regulation after publication.

Statutory Authority: § 32.1-12 and Chapter 7 (§ 32.1-249 et seq.) of Title 32.1 of the Code of Virginia.

Public comments may be submitted until October 30, 1998.

Contact: Deborah Little-Bowser, State Registrar of Vital Records, Department of Health, Vital Records, P.O. Box 1000, Richmond, VA 23219-1000, telephone (804) 225-5007, FAX (804) 786-0648 or toll-free 1-800-828-1120.

VA.R. Doc. No. R99-15; Filed September 9, 1998, 10:46 a.m.

DEPARTMENT OF MEDICAL ASSISTANCE SERVICES

Notice of Intended Regulatory Action

Notice is hereby given in accordance with § 9-6.14:7.1 of the Code of Virginia that the Department of Medical Assistance Services intends to consider amending regulations entitled: **12 VAC 30-50-10 et seq. Amount, Duration and Scope of Medical and Remedial Care and Services and 12 VAC 30-80-10 et seq. Methods and Standards for Establishing Payment Rates; Other Types of Care.** The purpose of the proposed action is to propose a consistent service coverage methodology and payment methodology for all intravenous infusion therapy services, without regard to patients' places of residence. The agency does not intend to hold a public hearing on the proposed regulation after publication.

Statutory Authority: § 32.1-325 of the Code of Virginia.

Public comments may be submitted until October 28, 1998, to Marianne Rollings, R.Ph., Division of Program Operations, Department of Medical Assistance Services, 600 East Broad Street, Suite 1300, Richmond, VA 23219.

Contact: Victoria P. Simmons, Regulatory Coordinator, Department of Medical Assistance Services, 600 E. Broad St., Suite 1300, Richmond, VA 23219, telephone (804) 371-8850 or FAX (804) 371-4981.

VA.R. Doc. No. R99-3; Filed August 31, 1998, 11:06 a.m.

Notice of Intended Regulatory Action

Notice is hereby given in accordance with § 9-6.14:7.1 of the Code of Virginia that the Department of Medical Assistance Services intends to consider amending regulations entitled: **12 VAC 30-70-10 et seq. Methods and Standards for**

Notices of Intended Regulatory Action

Establishing Payment Rates; Inpatient Hospital Care; 12 VAC 30-50-10 et seq. Amount, Duration, and Scope of Medical and Remedial Care and Services; and 12 VAC 30-60-10 et seq. Standards Established and Methods Used to Assure High Quality Care. The purpose of the proposed action is to propose permanent regulations to implement the diagnosis related groupings inpatient hospital system, providing for inpatient hospital services reimbursement, service prior authorization, and utilization control. The agency does not intend to hold a public hearing on the proposed regulation after publication.

Statutory Authority: § 32.1-325 of the Code of Virginia.

Public comments may be submitted until October 28, 1998, to Dennis G. Smith, Director, Department of Medical Assistance Services, 600 East Broad Street, Suite 1300, Richmond, VA 23219.

Contact: Victoria P. Simmons, Regulatory Coordinator, Department of Medical Assistance Services, 600 E. Broad St., Suite 1300, Richmond, VA 23219, telephone (804) 371-8850 or FAX (804) 371-4981.

VA.R. Doc. No. R99-2; Filed August 31, 1998, 11:06 a.m.

Notice of Intended Regulatory Action

Notice is hereby given in accordance with § 9-6.14:7.1 of the Code of Virginia that the Department of Medical Assistance Services intends to consider repealing regulations entitled: **12 VAC 30-80-10 et seq. Methods and Standards for Establishing Payment Rates; Other Types of Care: Repeal of Supplement Containing Pediatric/Obstetric Fees.** The purpose of the proposed action is to repeal a supplement from the State Plan for Medical Assistance because its presence in the state plan is no longer federally required pursuant to § 4713 of the Balanced Budget Act of 1997. The agency does not intend to hold a public hearing on the proposed repeal after publication.

Statutory Authority: § 32.1-325 of the Code of Virginia.

Public comments may be submitted until October 14, 1998.

Contact: Victoria P. Simmons, Regulatory Coordinator, Department of Medical Assistance Services, 600 E. Broad St., Suite 1300, Richmond, VA 23219, telephone (804) 371-8850 or FAX (804) 371-4981.

VA.R. Doc. No. R98-319; Filed August 19, 1998, 3:23 p.m.

Notice of Intended Regulatory Action

Notice is hereby given in accordance with § 9-6.14:7.1 of the Code of Virginia that the Department of Medical Assistance Services intends to consider amending regulations entitled: **12 VAC 30-120-10 et seq. Waivered Services: Medallion II.** The purpose of the proposed action is to establish annual enrollment periods for the Medallion II Program similar to those established in the private health insurance sector. The agency does not intend to hold a public hearing on the proposed regulation after publication.

Statutory Authority: § 32.1-325 of the Code of Virginia.

Public comments may be submitted until October 28, 1998, to Jim Cohen, Manager, Department of Medical Assistance Services, 600 East Broad Street, Suite 1300, Richmond, VA 23219.

Contact: Victoria P. Simmons, Regulatory Coordinator, Department of Medical Assistance Services, 600 E. Broad St., Suite 1300, Richmond, VA 23219, telephone (804) 371-8850 or FAX (804) 371-4981.

VA.R. Doc. No. R99-1; Filed August 31, 11:05 a.m.

TITLE 16. LABOR AND EMPLOYMENT

GOVERNOR'S EMPLOYMENT AND TRAINING DEPARTMENT

Notice of Intended Regulatory Action

Notice is hereby given in accordance with § 9-6.14:7.1 of the Code of Virginia that the Governor's Employment and Training Department intends to consider amending regulations entitled: **16 VAC 10-10-10 et seq. Public Participation Guidelines.** The purpose of the proposed action is to ensure that the regulations are fully compliant with the provisions of the Administrative Process Act and contain current, correct information for the Governor's Employment and Training Department. The agency does not intend to hold a public hearing on the proposed regulation after publication.

Statutory Authority: §§ 2.1-708 and 9-6.14:7.1 of the Code of Virginia.

Public comments may be submitted until October 28, 1998.

Contact: Louise Armstrong, Grants Administrative Supervisor, Governor's Employment and Training Department, Theater Row Bldg., 730 E. Broad St., 9th Floor, Richmond, VA 23219, telephone (804) 786-2508, FAX (804) 786-2340 or (804) 786-2315/TTY ☎.

VA.R. Doc. No. R99-18; Filed September 9, 1998, 10:22 a.m.

TITLE 18. PROFESSIONAL AND OCCUPATIONAL LICENSING

AUCTIONEERS BOARD

Notice of Intended Regulatory Action

Notice is hereby given in accordance with § 9-6.14:7.1 of the Code of Virginia that the Auctioneers Board intends to

Notices of Intended Regulatory Action

consider amending regulations entitled: **18 VAC 25-21-10 et seq. Rules and Regulations of the Virginia Auctioneers Board**. The purpose of the proposed action is to amend the regulations to ensure that they are in accordance with recent changes to the Code of Virginia and to ensure that the board's reinstatement requirements are clearly stated in the regulations. In addition, several other housekeeping matters and other changes to the regulation which may be necessary will be considered. The agency intends to hold a public hearing on the proposed regulation after publication.

Statutory Authority: §§ 54.1-201 and 54.1-602 of the Code of Virginia.

Public comments may be submitted until October 28, 1998.

Contact: Mark N. Courtney, Assistant Director, Department of Professional and Occupational Regulation, 3600 W. Broad St., Richmond, VA 23230-4917, telephone (804) 367-8514, FAX (804) 367-2475 or (804) 367-9753/TTY ☎

VA.R. Doc. No. R99-13; Filed September 2, 1998, 11:55 a.m.

BOARD OF HEALTH PROFESSIONS

Notice of Intended Regulatory Action

Notice is hereby given in accordance with § 9-6.14:7.1 of the Code of Virginia that the Board of Health Professions intends to consider amending regulations entitled: **18 VAC 75-30-10 et seq. Regulations Governing Standards for Dietitians and Nutritionists**. The purpose of the proposed action is to amend the credentials necessary for a person to hold in order to call oneself a dietitian or nutritionist. The agency intends to hold a public hearing on the proposed regulation after publication.

Statutory Authority: § 54.1-2400 of the Code of Virginia.

Public comments may be submitted until October 28, 1998.

Contact: Elaine J. Yeatts, Senior Regulatory Analyst, Department of Health Professions, 6606 W. Broad St., 4th Floor, Richmond, VA 23230-1717, telephone (804) 662-9918 or FAX (804) 662-9943.

VA.R. Doc. No. R99-4; Filed September 1, 1998, 11: 34 a.m.

BOARD OF MEDICINE

Notice of Intended Regulatory Action

Notice is hereby given in accordance with § 9-6.14:7.1 of the Code of Virginia that the Board of Medicine intends to consider amending regulations entitled: **18 VAC 85-20-10 et seq. Regulations Governing the Practice of Medicine, Osteopathy, Podiatry, Chiropractic and Physician Acupuncture**. The purpose of the proposed action is to amend the regulation as necessary to implement provisions of Senate Bill 660 of the 1998 General Assembly mandating the collection and disclosure of certain information on

physicians. The agency intends to hold a public hearing on the proposed regulation after publication.

Statutory Authority: § 54.1-2400 and Chapter 29 (§ 54.1-2900 et seq.) of the Code of Virginia.

Public comments may be submitted until October 28, 1998.

Contact: Warren W. Koontz, M.D., Executive Director, Board of Medicine, 6606 W. Broad St., 4th Floor, Richmond, VA 23230-1717, telephone (804) 662-9908 or FAX (804) 662-9943.

VA.R. Doc. No. R99-11; Filed September 1, 1998, 11: 34 a.m.

Notice of Intended Regulatory Action

Notice is hereby given in accordance with § 9-6.14:7.1 of the Code of Virginia that the Board of Medicine intends to consider amending regulations entitled: **18 VAC 85-31-10 et seq. Regulations Governing the Practice of Physical Therapy**. The purpose of the proposed action is to amend the regulations on continuing competency requirements, approval of inactive licensure status, and requirements for foreign-trained graduates. The Advisory Board on Physical Therapy will also conduct a biennial review and receive comments on any existing regulation. The agency intends to hold a public hearing on the proposed regulation after publication.

Statutory Authority: § 54.1-2400 and Chapter 29 (§ 54.1-2900 et seq.) of the Code of Virginia.

Public comments may be submitted until October 28, 1998.

Contact: Warren W. Koontz, M.D., Executive Director, Board of Medicine, 6606 W. Broad St., 4th Floor, Richmond, VA 23230-1717, telephone (804) 662-9908 or FAX (804) 662-9943.

VA.R. Doc. No. R99-10; Filed September 1, 1998, 11: 34 a.m.

Notice of Intended Regulatory Action

Notice is hereby given in accordance with § 9-6.14:7.1 of the Code of Virginia that the Board of Medicine intends to consider amending regulations entitled: **18 VAC 85-40-10 et seq. Regulations Governing the Practice of Respiratory Care Practitioners**. The purpose of the proposed action is to amend the regulations to require certain evidence of continuing competency for license renewal and to approve an inactive licensure status and the requirements for reactivation of such license. The agency intends to hold a public hearing on the proposed regulation after publication.

Statutory Authority: § 54.1-2400 and Chapter 29 (§ 54.1-2900 et seq.) of Title 54.1 of the Code of Virginia.

Public comments may be submitted until October 28, 1998.

Contact: Warren W. Koontz, M.D., Executive Director, Board of Medicine, 6606 W. Broad St., 4th Floor, Richmond, VA 23230-1717, telephone (804) 662-9908 or FAX (804) 662-9943.

Notices of Intended Regulatory Action

VA.R. Doc. No. R99-8; Filed September 1, 1998, 11: 34 a.m.

Notice of Intended Regulatory Action

Notice is hereby given in accordance with § 9-6.14:7.1 of the Code of Virginia that the Board of Medicine intends to consider amending regulations entitled: **18 VAC 85-50-10 et seq. Regulations Governing the Practice of Physician Assistants.** The purpose of the proposed action is to amend the regulations to approve inactive licensure status and requirements for reactivation of such license. The agency intends to hold a public hearing on the proposed regulation after publication.

Statutory Authority: § 54.1-2400 and Chapter 29 (§ 54.1-2900 et seq.) of Title 54.1 of the Code of Virginia.

Public comments may be submitted until October 28, 1998.

Contact: Warren W. Koontz, M.D., Executive Director, Board of Medicine, 6606 W. Broad St., 4th Floor, Richmond, VA 23230-1717, telephone (804) 662-9908 or FAX (804) 662-9943.

VA.R. Doc. No. R99-9; Filed September 1, 1998, 11: 34 a.m.

Notice of Intended Regulatory Action

Notice is hereby given in accordance with § 9-6.14:7.1 of the Code of Virginia that the Board of Medicine intends to consider amending regulations entitled: **18 VAC 85-80-10 et seq. Regulations for Licensure of Occupational Therapists.** The purpose of the proposed action is to amend the regulations to require certain evidence of continuing competency for license renewal and to approve an inactive licensure status and the requirements for reactivation of such license. The agency intends to hold a public hearing on the proposed regulation after publication.

Statutory Authority: § 54.1-2400 and Chapter 29 (§ 54.1-2900 et seq.) of Title 54.1 of the Code of Virginia.

Public comments may be submitted until October 28, 1998.

Contact: Warren W. Koontz, M.D., Executive Director, Board of Medicine, 6606 W. Broad St., 4th Floor, Richmond, VA 23230-1717, telephone (804) 662-9908 or FAX (804) 662-9943.

VA.R. Doc. No. R99-5; Filed September 1, 1998, 11:34 a.m.

Notice of Intended Regulatory Action

Notice is hereby given in accordance with § 9-6.14:7.1 of the Code of Virginia that the Board of Medicine intends to consider amending regulations entitled: **18 VAC 85-101-10 et seq. Regulations Governing the Licensure of Radiologic Technologists and Radiologic Technologists-Limited.** The purpose of the proposed action is to amend the regulations to require certain evidence of continuing competency for license renewal and to approve an inactive licensure status and the requirements of reactivation of such

license. The agency intends to hold a public hearing on the proposed regulation after publication.

Statutory Authority: § 54.1-2400 and Chapter 29 (§ 54.1-2900 et seq.) of Title 54.1 of the Code of Virginia.

Public comments may be submitted until October 28, 1998.

Contact: Warren W. Koontz, M.D., Executive Director, Board of Medicine, 6606 W. Broad St., 4th Floor, Richmond, VA 23230-1717, telephone (804) 662-9908 or FAX (804) 662-9943.

VA.R. Doc. No. R99-6; Filed September 1, 1998, 11: 34 a.m.

Notice of Intended Regulatory Action

Notice is hereby given in accordance with § 9-6.14:7.1 of the Code of Virginia that the Board of Medicine intends to consider amending regulations entitled: **18 VAC 85-110-10 et seq. Licensed Acupuncturists.** The purpose of the proposed action is to amend the regulations to require certain evidence of continuing competency for license renewal and to approve an inactive licensure status and the requirements of reactivation of such license. The agency intends to hold a public hearing on the proposed regulation after publication.

Statutory Authority: § 54.1-2400 and Chapter 29 (§ 54.1-2900 et seq.) of Title 54.1 of the Code of Virginia.

Public comments may be submitted until October 28, 1998.

Contact: Warren W. Koontz, M.D., Executive Director, Board of Medicine, 6606 W. Broad St., 4th Floor, Richmond, VA 23230-1717, telephone (804) 662-9908 or FAX (804) 662-9943.

VA.R. Doc. No. R99-7; Filed September 1, 1998, 11: 34 a.m.

TITLE 22. SOCIAL SERVICES

DEPARTMENT OF REHABILITATIVE SERVICES AND BOARD OF REHABILITATIVE SERVICES

† Notice of Intended Regulatory Action

Notice is hereby given in accordance with § 9-6.14:7.1 of the Code of Virginia that the Department of Rehabilitative Services and the Board of Rehabilitative Services intend to consider promulgating regulations entitled: **22 VAC 30-40-10 et seq. Protection of Human Research Participants.** The purpose of the proposed action is to establish a human research review committee and requirements for obtaining human participants' voluntary informed consent in human research conducted or authorized by the department, Woodrow Wilson Rehabilitation Center, or any sheltered workshop or center for independent living. The agency does

Notices of Intended Regulatory Action

not intend to hold a public hearing on the proposed regulation after publication.

Statutory Authority: §§ 51.5-5.1 and 51.5-14 of the Code of Virginia.

Public comments may be submitted until November 11, 1998.

Contact: Elizabeth Smith, Policy and Planning Manager, Department of Rehabilitative Services, 8004 Franklin Farms Dr., P.O. Box K300, Richmond, VA 23288-0300, telephone (804) 662-7071, FAX (804) 662-7696, toll-free 1-800-552-5019 or 1-800-464-9950/TTY ☎

VA.R. Doc. No. R99-19; Filed September 10, 1998, 2:05 p.m.

STATE BOARD OF SOCIAL SERVICES

Notice of Intended Regulatory Action

Notice is hereby given in accordance with § 9-6.14:7.1 of the Code of Virginia that the State Board of Social Services intends to consider repealing regulations entitled: **VR 615-52-11. Rules of the Interdepartmental Committee on Rate Setting.** This regulation establishes uniform policies and procedures for reviewing the costs for children's facilities that accept publicly funded children. Section 2.1-759.1 of the Code of Virginia nullified this regulation. The agency does not intend to hold a public hearing on the proposed repeal after publication.

Statutory Authority: § 2.1-759.1 of the Code of Virginia.

Public comments may be submitted until October 14, 1998.

Contact: Marjorie M. Jernigan, Adult Services Program Consultant, Department of Social Services, 730 E. Broad St., Richmond, VA 23219, telephone (804) 692-1262 or FAX (804) 692-2215.

VA.R. Doc. No. R98-317; Filed August 18, 1998, 2:15 p.m.

Notice of Intended Regulatory Action

Notice is hereby given in accordance with § 9-6.14:7.1 of the Code of Virginia that the State Board of Social Services intends to consider repealing regulations entitled: **22 VAC 40-50-10 et seq. Allowable Variance.** The allowable variance policy is no longer essential because it is a duplicative regulation. The policy has been incorporated into the regulation entitled General Procedures and Information for Licensure, 22 VAC 40-80-10 et seq. The agency does not intend to hold a public hearing on the proposed repeal after publication.

Statutory Authority: §§ 63.1-174 and 63.1-202 of the Code of Virginia.

Public comments may be submitted until October 14, 1998.

Contact: Kathryn Thomas, Program Development Supervisor, Division of Licensing Programs, Department of

Social Services, 730 E. Broad St., Richmond, VA 23219, telephone (804) 692-1793 or FAX (804) 692-2370.

VA.R. Doc. No. R98-315; Filed August 19, 1998, 9:21 a.m.

Notice of Intended Regulatory Action

Notice is hereby given in accordance with § 9-6.14:7.1 of the Code of Virginia that the State Board of Social Services intends to consider promulgating regulations entitled: **22 VAC 40-325-10 et seq. Fraud Reduction/Elimination Effort.** The purpose of the proposed action is to establish regulations to operate a statewide fraud control program as mandated in § 63.1-58.2 of the Code of Virginia. The agency does not intend to hold a public hearing on the proposed regulation after publication.

Statutory Authority: §§ 63.1-58.2 of the Code of Virginia.

Public comments may be submitted until October 28, 1998.

Contact: Patricia T. Wright, Special Assistant to the Inspector General, Department of Social Services, 730 E. Broad St., Richmond, VA 23219, telephone (804) 692-1269.

VA.R. Doc. No. R99-12; Filed September 1, 1998, 3:02 p.m.

Notice of Intended Regulatory Action

Notice is hereby given in accordance with § 9-6.14:7.1 of the Code of Virginia that the State Board of Social Services intends to consider amending regulations entitled: **22 VAC 40-670-10 et seq. Degree Requirement for Social Work/Social Work Supervision.** The purpose of the proposed action is to modify the regulation to provide local agency flexibility for hiring and promotions. The agency does not intend to hold a public hearing on the proposed regulation after publication.

Statutory Authority: §§ 63.1-25 and 63.1-26 of the Code of Virginia.

Public comments may be submitted until October 14, 1998.

Contact: Vivian Flythe Cook, Personnel Practices Manager, Department of Social Services, 730 E. Broad St., Richmond, VA 23219, telephone (804) 692-1561 or FAX (804) 692-1599.

VA.R. Doc. No. R98-316; Filed August 18, 1998, 2:15 p.m.

Notice of Intended Regulatory Action

Notice is hereby given in accordance with § 9-6.14:7.1 of the Code of Virginia that the State Board of Social Services intends to consider amending regulations entitled: **22 VAC 40-690-10 et seq. Child Day Care Scholarship Program.** The purpose of the proposed action is to amend the regulation to accurately reflect the administration of the child day care scholarship program. The agency does not intend to hold a public hearing on the proposed regulation after publication.

Statutory Authority: § 63.1-25 of the Code of Virginia.

Notices of Intended Regulatory Action

Public comments may be submitted until October 14, 1998.

Contact: Rhonda M. Harrell, Program Development Coordinator, Department of Social Services, 730 E. Broad St., Richmond, VA 23219, telephone (804) 692-1775 or FAX (804) 692-2370.

VA.R. Doc. No. R98-314; Filed August 20, 1998, 2:20 p.m.

Notice of Intended Regulatory Action

Notice is hereby given in accordance with § 9-6.14:7.1 of the Code of Virginia that the State Board of Social Services intends to consider amending regulations entitled: **22 VAC 40-705-10 et seq. Child Protective Services.** The purpose of the proposed action is to be consistent with and fully implement legislation enacted by the General Assembly. The agency intends to hold a public hearing on the proposed regulation after publication.

Statutory Authority: § 63.1-25 of the Code of Virginia.

Public comments may be submitted until October 14, 1998.

Contact: Deron M. Phipps, Policy Consultant, Department of Social Services, 730 E. Broad St., Richmond, VA 23219, telephone (804) 692-1220 or FAX (804) 692-2215.

VA.R. Doc. No. R98-318; Filed August 20, 1998, 2:19 p.m.

† Notice of Intended Regulatory Action

Notice is hereby given in accordance with § 9-6.14:7.1 of the Code of Virginia that the State Board of Social Services intends to consider repealing regulations entitled: **22 VAC 40-820-10 et seq. Policy Regarding Purchased Services.** The purpose of the proposed action is to eliminate duplicative regulations regarding the purchase of services by local departments of social services. Existing regulations and policies for each program area will be followed. The agency does not intend to hold a public hearing on the proposed repeal after publication.

Statutory Authority: § 63.1-25 of the Code of Virginia.

Public comments may be submitted until November 11, 1998.

Contact: Marjorie L. Marker, Adult Services Program Consultant, Department of Social Services, 730 E. Broad St., Richmond, VA 23219, telephone (804) 692-1262 or FAX (804) 692-2215.

VA.R. Doc. No. R99-21; Filed September 17, 1998, 11:49 a.m.

† Notice of Intended Regulatory Action

Notice is hereby given in accordance with § 9-6.14:7.1 of the Code of Virginia that the State Board of Social Services intends to consider amending regulations entitled: **22 VAC 40-880-350. Child Support Enforcement Program: Distraint, Seizure and Sale.** The purpose of the proposed action is to enhance statewide the department's ability to

collect child support debt from legally obligated parents, using a new technique of seizure and sale of the individual's automobile via the use of a "boot." The boot is a device which, following proper due process notification, is applied to the wheel of the vehicle by a sheriff or policy officer, thus disabling the vehicle from moving until the boot is removed. Removal results from the individual's completing full payment of the outstanding child support debt, or reaching a payment agreement plus the payment of at least \$500 or 10% of the outstanding balance, whichever is greater. This procedure has already been used with distinct success in one locality in Virginia, Fairfax County, where local ordinances allow the procedure. The purpose of this revision to the regulation is to provide authorization so that the booting procedure can be implemented in all political subdivisions of the Commonwealth. The agency does not intend to hold a public hearing on the proposed repeal after publication.

Statutory Authority: § 63.1-261 of the Code of Virginia.

Public comments may be submitted until November 11, 1998.

Contact: Bill Brownfield, Manager, Policy Development and Support Unit, Division of Child Support Enforcement, Department of Social Services, 730 E. Broad St., Richmond, VA 23219, telephone (804) 692-2401 or FAX (804) 692-2410.

VA.R. Doc. No. R99-20; Filed September 17, 1998, 11:49 a.m.



PUBLIC COMMENT PERIODS - PROPOSED REGULATIONS



PUBLIC COMMENT PERIODS REGARDING STATE AGENCY REGULATIONS

This section gives notice of public comment periods and public hearings to be held on proposed regulations. The notice will be published once at the same time the proposed regulation is published in the Proposed Regulations section of the *Virginia Register*. The notice will continue to be carried in the Calendar of Events section of the *Virginia Register* until the public comment period and public hearing date have passed.

Notice is given in compliance with § 9-6.14:7.1 of the Code of Virginia that the following public hearings and public comment periods regarding proposed state agency regulations are set to afford the public an opportunity to express their views.

TITLE 11. GAMING

VIRGINIA RACING COMMISSION

November 18, 1998 - 9:30 a.m. – Public Hearing
Virginia Racing Commission, 12007 Courthouse Circle,
Administrative Building, New Kent, Virginia.

December 11, 1998 - Public comments may be submitted
until this date.

Notice is hereby given in accordance with § 9-6.14:7.1 of the Code of Virginia that the Virginia Racing Commission intends to amend regulations entitled: **11 VAC 10-60-10 et seq. Regulations Pertaining to Horse Racing with Pari-Mutuel Wagering: Participants.** The proposed regulation reflects more closely the intent of the statute regarding the consideration of applications for participation in horse racing, thereby eliminating the provisional permit. Furthermore, the regulation takes into account changes in the standard operating procedures found at most racetracks in the mid-Atlantic region since the current regulation was promulgated seven years ago.

Statutory Authority: § 59.1-369 of the Code of Virginia.

Contact: William H. Anderson, Policy Analyst, Virginia Racing Commission, 10700 Horsemen's Road, New Kent, VA 23124, telephone (804) 966-4200 or FAX (804) 966-8906.



PROPOSED REGULATIONS

For information concerning Proposed Regulations, see Information Page.

Symbol Key

Roman type indicates existing text of regulations. *Italic type* indicates proposed new text.
Language which has been stricken indicates proposed text for deletion.

TITLE 11. GAMING

VIRGINIA RACING COMMISSION

Title of Regulation: 11 VAC 10-60-10 et seq. **Regulations Pertaining to Horse Racing with Pari-Mutuel Wagering: Participants (amending 11 VAC 10-60-10, 11 VAC 10-60-20, 11 VAC 10-60-40, 11 VAC 10-60-70, 11 VAC 10-60-120, 11 VAC 10-60-130, 11 VAC 10-60-140, and 11 VAC 10-60-150; adding 11 VAC 10-60-15, 11 VAC 10-60-290, 11 VAC 10-60-300, 11 VAC 10-60-310, and 11 VAC 10-60-320; repealing 11 VAC 10-60-30 and 11 VAC 10-60-60).**

Statutory Authority: § 59.1-369 of the Code of Virginia.

Public Hearing Date: November 18, 1998 - 9:30 a.m.

Public comments may be submitted until December 11, 1998.

(See Calendar of Events section for additional information)

Basis: The Virginia Racing Commission derives its statutory authority to promulgate regulations from the provisions of § 59.1-369 of the Code of Virginia. The section states, in part in subdivision 3, "The Commission shall promulgate regulations and conditions under which horse racing with pari-mutuel wagering shall be conducted in the Commonwealth, and all such other regulations it deems necessary and appropriate to effect the purposes of this chapter."

Purpose: The commission has promulgated this regulation to achieve its statutory purpose of maintaining horse racing in the Commonwealth of the highest quality. The proposed regulation reflects more closely the intent of the statute regarding the consideration of applications for participation in horse racing thereby eliminating the provisional permit. Furthermore, the regulation takes into account changes in the standard operating procedures found at most racetracks in the mid-Atlantic region since the current regulation was promulgated seven years ago. The proposed regulation amends the existing regulation pertaining to participants in horse racing with pari-mutuel wagering to promote the public health, safety and welfare.

Substance: The proposed regulation repeals the sections pertaining to provisional permits and clarifies the procedures under which applications for permits shall be considered by the commission. The regulation also clarifies the responsibilities of participants regarding alcohol and drug testing, provision of workers' compensation insurance coverage for employees, disorderly conduct and unwarranted objections. The regulation also specifies that permit holders shall provide a current mailing address.

Further, the regulation incorporates the practices of other jurisdictions, primarily Maryland, regarding the responsibilities placed upon owners of racehorses. These amendments were necessitated by the demise of the thoroughbred ownership registry of The Jockey Club.

The proposed regulation also incorporates the practices of other jurisdictions as to the responsibilities placed upon jockeys and apprentice jockeys. It also introduces an apprentice certificate which has been instituted among the racing states in the mid-Atlantic region. It also establishes a multiple engagement regulation for jockeys which parallels regulations in other jurisdictions.

Finally, the proposed regulation more appropriately shifts four categories of permit holders from the chapter pertaining to racing officials to the chapter pertaining to participants.

Issues: The proposed regulation was promulgated with the input of counsel from the Attorney General's Office as well as the commission's experience in administering the initial race meeting at Colonial Downs. Furthermore, representatives of the horse industry, primarily the Jockeys' Guild and racing officials from Colonial Downs, were intensely involved in the revision of the regulation. The proposed regulation essentially updates the previous regulation by eliminating outmoded procedures. The proposed regulation further creates the advantage of providing uniformity among neighboring jurisdictions while not creating a disadvantage for the Commonwealth or the public.

Department of Planning and Budget's Economic Impact

Analysis: The Department of Planning and Budget (DPB) has analyzed the economic impact of this proposed regulation in accordance with § 9-6.14:7.1 G of the Administrative Process Act and Executive Order Number 13 (94). Section 9-6.14:7.1 G requires that such economic impact analyses include, but need not be limited to, the projected number of businesses or other entities to whom the regulation would apply, the identity of any localities and types of businesses or other entities particularly affected, the projected number of persons and employment positions to be affected, the projected costs to affected businesses or entities to implement or comply with the regulation, and the impact on the use and value of private property. The analysis presented below represents DPB's best estimate of these economic effects.

Summary of the proposed regulation. This proposed regulation amends existing regulations regarding the qualifications, duties, and responsibilities of participants in pari-mutuel horse racing. Specifically, the proposed regulation incorporates changes in standard operating procedures for racetracks in the mid-Atlantic region; allows licensees reciprocity if licensed in another state with similar regulatory requirements; and clarifies sections dealing with

permit application procedures, including the repeal of provisional permits. According to the Virginia Racing Commission (VRC), these changes are not expected to have an effect on the number of permits issued. Several sections which previously listed specific requirements (e.g., illegal alcohol content levels for participants, individuals covered under workers' compensation) are replaced with references to the Code of Virginia. This change would eliminate the need to update the regulations each time there is a statutory change.

Estimated economic impact. The majority of the proposed changes are essentially technical in nature and are intended to streamline the regulation and bring Virginia's regulations in line with those of other regional racing authorities. Individually, these changes would not have significant economic consequences, but their overall effect will be to facilitate Virginia's ability to fully participate in the regional horse racing industry. Fuller participation is likely to result in a small, net economic gain for Virginia's horse racing industry.

Businesses and entities affected. This proposal will affect all participants in the horse racing industry. Currently, the commission licenses approximately 5,000 individuals each year, including owners, trainers, jockeys, and grooms.

Localities particularly affected. The benefits of this proposal will most likely be concentrated in the areas around the Colonial Downs racetrack and regions of the Commonwealth where racehorses are bred and trained.

Projected impact on employment. This regulation is not expected to have a significant impact on employment in Virginia.

Effects on the use and value of private property. This regulation is not expected to have a significant effect on the use and value of private property.

Summary of analysis. By placing Virginia's regulations on equal footing with those of neighboring states, the proposed regulation is likely to enhance the potential for development of the horse racing industry in Virginia and can be expected to result in a small, net economic gain for that industry.

Agency's Response to the Department of Planning and Budget's Economic Impact Analysis: The Virginia Racing Commission has reviewed the economic impact analysis prepared by the Department of Planning and Budget, and the commission finds that it is in general agreement with the analysis.

Summary:

The proposed amendments incorporate changes in standard operating procedures for racetracks in the mid-Atlantic region; allow licensees reciprocity if licensed in another state with similar regulatory requirements; and clarify sections dealing with permit application procedures, including the repeal of provisional permits. Several sections which previously listed specific requirements (e.g., illegal alcohol content levels for participants and individuals covered under workers'

compensation) are replaced with references to the Code of Virginia. This change would eliminate the need to update the regulations each time there is a statutory change.

11 VAC 10-60-10. Generally.

No person shall participate in any horse racing subject to the jurisdiction of the commission or in the conduct of a race meeting or pari-mutuel wagering of the race meeting unless the person possesses a permit from the commission and complies with the provisions of the Act and the regulations of the commission. Permits issued by the commission are not transferable.

A. Application for permit. A person desiring to obtain a permit to participate in horse racing, with pari-mutuel wagering, shall make an application for a permit on a form prescribed by the commission. The application shall be accompanied by a fee prescribed by the commission and the cost of fingerprinting. The applicant shall be photographed. ~~The applicant shall also be fingerprinted upon making his initial application in the Commonwealth and at least once every five years thereafter.~~ The application shall be verified by the oath or affirmation of the applicant.

B. Fee schedule. Before submitting an application for a permit as a participant, the applicant shall consult the fee schedule (11 VAC 10-60-15) of the Virginia Racing Commission to ascertain the applicable fee, make out a check or money order payable to the Virginia Racing Commission or pay in cash the full amount of the fee, and submit the fee with the application.

~~C. Provisional permit. Pending the completion of a background investigation into the qualifications and fitness of an applicant for a permit, the commission shall grant a provisional permit in accordance with the following provisions:~~

~~1. The applicant shall be permitted to participate in horse racing to the extent allowed by the permit for which application was made;~~

~~2. The applicant, in the exercise of reasonable care and diligence, could not have made application in time for a decision to be made on the applicant's qualifications and fitness; and~~

~~3. The commission has no reason to believe that the applicant is ineligible for the permit for which application was made.~~

~~D. Termination of provisional permit. A provisional permit shall terminate upon a decision of the commission to approve or deny the application for a permit, or 120 days after the grant of the provisional permit, whichever occurs first. A provisional permit shall carry no presumption of qualifications or fitness, and may be terminated summarily by the commission for cause.~~

~~E. Recommendation by stewards. The stewards, employed as racing officials by the commission, shall promptly consider an application, and shall approve or deny the application based on the information in the application~~

Proposed Regulations

~~and all other information before them, including any investigation they deem appropriate. If an application is approved by the stewards, the permit shall be valid for one year.~~

~~F. Denial of application. The stewards shall deny the application, if they find that the approval of a permit for the person would not be in the best interests of the people of the Commonwealth, or the horse racing industry of the Commonwealth, or would reflect adversely on the honesty and integrity of the horse racing industry in the Commonwealth, or that the applicant:~~

- ~~1. Has knowingly made a false statement of a material fact in the application, or has deliberately failed to disclose any information requested by the commission;~~
- ~~2. Is or has been guilty of any corrupt or fraudulent practice or conduct in connection with any horse race meeting in this or any other state;~~
- ~~3. Has knowingly failed to comply with the provisions of the Act or the regulations of the commission;~~
- ~~4. Has had a permit to engage in activity related to horse racing denied for just cause, suspended or revoked in any other jurisdiction, and such denial, suspension or revocation is still in effect;~~
- ~~5. Is not qualified to perform the duties required for the permit sought; or~~
- ~~6. Has been convicted in any jurisdiction of a misdemeanor or felony involving unlawful conduct or wagering, fraudulent use of a credential, unlawful transmission of information, touting, bribery, administration or possession of drugs or any misdemeanor or felony considered by the commission to be detrimental to horse racing in the Commonwealth.~~

~~G. Denial is final. The denial of an application by the stewards as a participant in horse racing shall be final unless an appeal is made by the applicant under the provisions of these regulations.~~

C. Reciprocity. The commission shall conduct a review of the statutes of other jurisdictions pertaining to horse racing with pari-mutuel wagering to ascertain which jurisdictions have substantially the same standards as those of Virginia. Upon submission of an application and payment of the prescribed fee by a holder of a permit, license or other similar document from those jurisdictions whose standards for permits, licenses or similar documents are substantially the same, the commission may, in its discretion, grant reciprocity to the applicant provided that the applicant has not been convicted of a misdemeanor or felony.

D. Fingerprinting. The applicant shall be fingerprinted upon making his initial application in the Commonwealth and at least once every five years thereafter. The commission may waive this requirement in connection with an application for a permit by reciprocity with another jurisdiction provided that the applicant was fingerprinted and was subjected to a criminal history record information check in a jurisdiction

whose laws governing fingerprinting and background investigations are substantially the same as required by Virginia and that he has not been convicted of a misdemeanor or a felony. However, the commission, in its discretion, may require fingerprints from any applicant or holder of a permit at any time.

E. Consideration of application. The commission, acting through its executive secretary or other designee, shall promptly consider any application for a permit and issue the permit based on the information contained in the application and all other information before it, including any investigation it deems appropriate. If an application for a permit is approved, the commission shall issue the permit.

F. Denial of application. If from the face of the application, an applicant appears ineligible because of the requirements specified in § 59.1-389 B of the Code of Virginia, his application shall be denied by the commission, acting through its executive secretary or other designee. The commission may deny an application for a permit for the reason specified in § 59.1-389 C of the Code of Virginia. Absent mitigating circumstances, the application for a permit shall be denied if the applicant has been convicted for solicitation/prostitution within five years next preceding the application date or has three or more misdemeanor convictions, regardless of offense, within five years preceding the application date. If the applicant has multiple convictions of the same offense on the same day, it shall not constitute three or more misdemeanor convictions for purposes of this regulation. The applicant may withdraw his application prior to denial.

G. Ineligible applicant. If it appears that the applicant may be ineligible because he has committed a felony or misdemeanor that may be detrimental to horse racing in the Commonwealth, he shall be afforded the opportunity to withdraw his application or request a hearing before a steward regarding his application. However, the commission, in its discretion, may issue a permit to an applicant providing the felony or misdemeanor is not one of those listed in § 59.1-389 B 6 of the Code of Virginia.

H. Renewal of permit. A holder of a currently valid permit may renew the permit annually by making application for a renewal on a form prescribed by the commission. The application for a renewal of a permit shall be accompanied by a fee prescribed by the commission. The applicant may be photographed with each application for a renewal.

I. Knowledge of regulations. A holder of a permit shall be familiar with and knowledgeable of the regulations of the commission. Every holder of a permit is presumed to know the regulations.

J. Reporting violations. A holder of a permit shall report immediately to the ~~stewards~~ commission every observed violation of these regulations as well as all violations of state and federal laws during the race meeting.

K. Multiple participation. A holder of a permit may participate in horse racing in more than one capacity, with the exception of those capacities specifically prohibited by these regulations. A holder of a permit shall ~~declare~~ submit,

in writing on a form prescribed by the commission, a request for approval of his multiple participation in horse racing. The stewards ~~may~~ shall deny a request for multiple participation where it would, in their discretion, pose a potential conflict of interest. Where approval is granted to a holder of a valid permit, ~~the~~ all applicable ~~fee~~ fees shall be paid by the participant.

L. Employment of unauthorized participants. A holder of a permit shall not employ for participation within the enclosure any person who does not possess the appropriate permit issued by the commission or has not made application for the appropriate permit.

M. Financial responsibility. A holder of a permit, who obtains food, shelter, medicine, transportation, veterinary services or other goods and services for himself or for others shall be responsible for paying for those goods and services. The stewards shall neither be obligated to collect debts nor intervene where there is a dispute over a debt, unless in receipt of a judgment from a duly constituted court in the Commonwealth.

N. Possession of permit. A holder of a permit shall have in his possession at all times his permit issued by the commission and shall be responsible for its safekeeping. The holder shall display his permit to gain entry to the enclosure or upon the request of appropriate racing officials, commission personnel or security personnel.

O. Duplicate permit. A holder of a permit shall report immediately to the stewards the loss of his permit and immediately make application for a duplicate. The stewards shall notify the appropriate security personnel of the loss of the permit.

P. Misuse of permit. A holder of a permit shall not allow another person to use his permit for the purpose of obtaining any benefits or privileges pertaining to the permit.

Q. Search and seizure. ~~An applicant for~~ A holder of a permit shall consent upon application and for the duration of the permit, ~~if issued,~~ to personal inspections (searches) of the ~~applicant~~ holder, inspections (searches) of the ~~applicant's~~ holder's personal property, and inspections (searches) of the premises and property *located within the enclosure of the racetrack* related to his participation in a race meeting by persons authorized by the commission, and to seizure of such property as is determined by the commission's designee conducting the search to be in violation of Chapter 29 (§ 59.1-364 et seq.) of Title 59.1 of the Code of Virginia, or this chapter. The following provisions shall apply to searches and seizures:

1. Any drug, stimulant, narcotic, controlled substance, drug paraphernalia, hypodermic needle, hypodermic syringe, battery or other electrical or mechanical appliance or any other device or substance which could be used to affect the speed or action of a horse, or any other device prohibited by this chapter that is in the possession of an ~~applicant,~~ a holder of a permit ~~or a holder of a provisional permit~~ may be seized;

2. Commission personnel have the right to enter into, or upon buildings, stables, rooms (other than residences), private vehicles or other places within the enclosure, and ~~shall~~ may examine them, and inspect and examine personal property and effects of a holder of a permit ~~or holder of a provisional permit~~ for the purpose of determining that the items listed in subdivision 1 of this subsection are not in the possession of a permit holder, ~~applicants or holders of provisional permits~~ unless authorized by Chapter 29 of Title 59.1 of the Code of Virginia or this chapter; ~~and.~~

3. In addition, commission personnel shall visit, investigate, and have free access to the office, track, facilities, or other places of business of any licensee or permit holder and may compel the production of any of the books, documents, records, or memoranda of any licensee or permit holder for the purpose of satisfying themselves that Chapter 29 of Title 59.1 of the Code of Virginia and this chapter are being strictly complied with;

4. Failure to submit to any inspection or search described above or to any production of documents or seizure of property resulting therefrom, may subject a licensee, or a holder of a permit ~~or a holder of a provisional permit~~ to disciplinary action. In the event that such licensee or permit holder, ~~applicant, or holder of a provisional permit~~ refuses to submit, the following procedure shall apply:

Such refusal shall be immediately reported to the stewards by the person attempting to conduct the search. Such refusal, and the basis therefor, shall be provided in writing to the stewards by the permit ~~or provisional permit~~ holder ~~or applicant~~ and shall state the date, time and circumstances of the attempted search, and his reason(s) for refusing to submit to it. Upon receipt of such report, the stewards may take appropriate disciplinary action ~~in conformity with the provisions of these regulations including suspension or, which may include the revocation or suspension of the permit or referral to the appropriate law-enforcement authorities, but in no event shall the search or seizure proceed of the permit holder or any of his property be detained at that time~~ neither the search nor any seizure of the property shall proceed.

5. The foregoing shall not preclude commission personnel from conducting searches and seizures when they have reasonable suspicion that a ~~person~~ permit holder is in the act of violating a regulation or evidence of a violation of a regulation may be destroyed, in which event the provisions of these regulations dealing with consent, refusal to consent, scope of search and disciplinary action shall apply.

R. Workers' compensation. An applicant for a permit, ~~where the person acts as an employer of three or more persons within the enclosure, shall purchase and maintain workers' compensation insurance, and shall submit, with his application, a copy of the declaration page or certificate of~~

Proposed Regulations

~~insurance. Should workers' compensation insurance coverage be terminated or canceled, the permit of the person may be suspended or revoked who is subject to the compensation provisions of the Virginia Workers' Compensation Act (§ 65.2-100 et seq. of the Code of Virginia) shall comply with the provisions of the Virginia Workers' Compensation Act regarding insurance and self-insurance and shall submit proof of his compliance with his application for a permit. Failure to remain in compliance with the insurance and self-insurance provisions of the Virginia Workers' Compensation Act throughout the duration of the permit shall constitute grounds for its revocation or suspension.~~

S. Supervision of employees. A holder of a permit who is an employer shall supervise his employees so that their participation in horse racing is in accordance with these regulations, and shall be held jointly responsible for the actions of his employees as they relate to racing matters.

T. Human drug testing. The use, possession or transportation of any controlled substance or drug as those terms are defined in the Virginia Drug Control Act (§ 54.1-3400 et seq. of the Code of Virginia) is prohibited *within the enclosure of the racetrack* unless the controlled substance or drug was obtained pursuant to a valid prescription or order from a duly licensed physician who is acting in the course of his professional practice or is otherwise authorized by these regulations. It shall be the responsibility of the holder of a permit to provide proof that he is using, possessing or transporting the controlled substance or drug pursuant to a valid prescription or order from a duly licensed physician or that such use, possession or transportation is otherwise authorized by these regulations.

In addition, the following provisions shall apply to the use or possession of controlled substances or drugs:

1. Any apprentice jockey, assistant starter, assistant trainer, clerk of scales, *driver of Standardbreds*, driver of starting gate, exercise rider, farrier, groom, hotwalker, identifier, jockey, outrider, ~~owner~~, paddock judge, patrol judge, placing judge, pony rider, starter, steward, trainer, valet, veterinarian or veterinarian's assistant at any horse racing facility licensed by the commission may be subjected by the commission or its designee to a urine test or other fluid test, including a blood test, for the purpose of detection of the presence of controlled substances, in the *following manner prescribed below*:

a. At least once per week during the course of every unlimited race meeting, the executive secretary of the commission, or his designee, shall direct that the above-described testing be conducted. The day of each such testing shall be selected by the executive secretary or his designee at random and shall not be announced to the persons affected until the day so selected shall have arrived; and

b. Each sample shall be provided in the presence of the licensee's physician or other representative appointed by the executive secretary or his designee

and in sufficient quantity to provide a split sample whenever possible. Such sample(s) shall be immediately sealed and tagged ~~on the form provided by the commission~~. Evidence of such sealing shall be indicated by the signature of the tested permit holder, but the portion of the form which is provided to the laboratory for analysis shall not identify the individual permit holder by name. Only laboratories approved by the commission may be used in obtaining analysis reports or urine or other specimens. The commission and the stewards shall receive reports directly from the laboratory. If the permit holder so requests in writing to the stewards within 48 hours of notice of a positive lab report on the test sample submitted, the second portion shall be sent for further testing to a drug testing laboratory designated and approved by the commission. All costs for the transportation and testing of the second sample portion shall be the financial responsibility of the requesting permit holder, and payment shall be due from the requesting permit holder within 30 days of receipt of notice of the costs. The licensee's physician or other representative appointed by the executive secretary or his designee shall have overall responsibility for the preservation, storage and safeguarding of the second sample portion.

2. Notwithstanding the foregoing, any steward, acting with reasonable suspicion, may direct any holder of a permit, whether or not listed in the categories above, to submit a specimen of urine, or to submit to any other fluid test including a blood test for the detection of controlled substances or drugs, in which event the provisions of these regulations dealing with collection of sample(s), failure to provide a sample, positive sample test(s), and disciplinary action shall apply.

3. The presence in a sample of metabolites of ~~opoid~~ *opiod*, barbiturate, cannabis, cocaine, amphetamine, hallucinogen, phencyclidine-type drugs, volatile solvents or volatile nitrates, or other mood-altering or dependency-causing controlled substances or drugs will be considered a positive test. A positive test result shall be reported, in writing, to the executive secretary or his designee, who shall notify the permit holder involved in writing as quickly as possible.

4. In the event of a positive test, the following shall also apply:

a. For an initial positive test, a holder of a permit shall undergo a professional evaluation, at his own expense, by a physician approved by the stewards. If the evaluation indicates that the person's condition is nonaddictive and not detrimental to the best interests of horse racing, the person shall be allowed to participate in horse racing; after producing a negative test and agreeing to undergo random testing for a period of ~~no~~ *not* greater than six months at the discretion of the stewards;

b. If the evaluation indicates the person's condition is addictive or detrimental to the best interests of horse

racing, the person shall not be allowed to participate in horse racing until he can produce a negative test, has successfully completed a drug rehabilitation program acceptable to the commission, and agrees to undergo random testing for a period of not greater than six months at the discretion of the stewards; and

c. For a second positive test, a holder of a permit shall be suspended indefinitely by the stewards and may only apply for reinstatement after having successfully completed a drug rehabilitation program acceptable to the commission and agreeing to undergo random testing for a period of not greater than one year at the discretion of the stewards.

5. Notwithstanding the foregoing, a holder of a permit whose sample is positive may be subject to disciplinary action including but not limited to revocation or suspension of his permit.

U. Human alcohol testing. ~~On any racing day, any holder of a permit may not have present within his system an amount of alcohol which would constitute being under the influence of alcohol, defined as .10% alcohol content or more, or being impaired, defined as between .09% and .05% alcohol content. No holder of a permit shall have present within his system an amount of alcohol which would give rise to the presumption that he was under the influence of alcohol intoxicants as specified in § 18.2-269 A 3 of the Code of Virginia while performing or liable to perform those duties for which a permit is required.~~ In addition, the following provisions shall apply to the consumption of alcoholic beverages:

1. The commission hereby adopts breath testing as its approved method of testing for the presence of alcohol in humans and adopts the following procedure for such testing:

a. Any apprentice jockey, assistant ~~starters~~ starter, assistant trainer, clerk of scales, ~~driver of Standardbreds~~, driver of a starting gate, exercise rider, farrier, groom, hotwalker, identifier, jockey, outrider, ~~owner~~, paddock judge, patrol judge, placing judge, pony rider, starter, steward, trainer, valet, veterinarian or veterinarian's assistant at any horse racing facility licensed by the commission may be required to take a breath alcohol test ~~no later than one hour before~~ prior to his participation in horse racing commences;

b. Testing devices shall be selected by the commission from among those listed on the Conforming Products List of Evidential Breath Measurement Devices amended and published in the Federal Register from time to time by the National Highway Traffic Safety Administration (NHTSA), United States Department of Transportation;

c. Each device shall be properly maintained and shall be calibrated by the use of calibrating unit listed on the NHTSA Conforming Products List of Calibrating Units for Breath Alcohol Testers (as amended) with

sufficient frequency to ensure the accuracy of the device (within plus or minus .01%), but not less ~~frequent~~ frequently than provided in the manufacturer's instructions;

d. Tests shall be conducted by a trained and qualified operator. The operator shall have received training on the operational principles of the particular instrument employed and practical experience in the operation of the device and use of the breath alcohol calibrating unit; and

e. Tests shall be conducted in accordance with procedures specified by the manufacturer of the testing device, consistent with sound technical judgment, and shall include appropriate restrictions on ambient air temperature.

2. Notwithstanding the foregoing, any steward, acting with reasonable suspicion, may direct any holder of a permit, whether or not listed in the categories above, to submit to a breath alcohol test, in which event the provisions of ~~these regulations dealing with refusal to undergo a breath test, positive test(s), and disciplinary action~~ subdivision 4 of this subsection shall apply.

3. A holder of a permit *listed in subdivision 1 a of this subsection* who is impaired shall not participate in horse racing on that day, but for the first occurrence, shall not be subject to further disciplinary action; a second or subsequent occurrence shall subject such permit holder to disciplinary action.

4. A holder of a permit who is under the influence of alcohol or refuses to take a breath alcohol test at the direction of the stewards, is subject to disciplinary action.

V. Reciprocity of rulings. ~~Any person who has been issued a permit by the commission and has a holder of a permit whose permit or license to engage in any activity related to horse racing denied for just cause, suspended or revoked in any other jurisdiction, and such denial, suspension or revocation is still in effect in any other jurisdiction has been denied, suspended or revoked for just cause in that jurisdiction shall not be permitted to participate in horse racing with pari-mutuel wagering in the Commonwealth of Virginia if such denial, suspension or revocation is still in effect.~~

W. Official address. All notices required by law and by regulations of the commission to be mailed by the commission to any holder of a permit shall be validly given when mailed to the latest address on file with the commission. Each holder of a permit shall maintain a record of his current mailing address with the commission. Any change of address by a holder of a permit shall be submitted in writing to the commission within 30 days of such change.

X. Disorderly conduct. A holder of a permit shall not engage in disorderly conduct, which shall include but not be limited to using profane, abusive or insulting language, or

Proposed Regulations

assaulting or threatening to assault other participants, racing officials, commission employees or the public.

Y. Unwarranted objection. A holder of a permit may be subject to disciplinary action by the stewards if they determine that the objection or protest is unwarranted and without merit.

11 VAC 10-60-15. Fee schedule for permit holders.

Type of Permit	Fee
Apprentice Jockey	\$10
Assistant General Manager	\$10
Assistant Racing Secretary	\$10
Assistant Starter	\$5
Assistant Trainer	\$10
Authorized Agent	\$10
Claims Clerk	\$10
Clerk of Scales	\$10
Clerk of the Course	\$10
Clocker	\$10
Concessionaire/Vendor	\$25
Concessionaire/Vendor Employee	\$5
Corporate Horse Owner	\$25
Custodian of Jockeys' Room	\$10
Director of Security	\$10
Driver	\$10
Entry Clerk	\$10
Exercise Rider	\$10
Farrier	\$10
Foreman	\$10
Gap Attendant	\$10
General Manager	\$10
Groom/Hotwalker	\$5
Horse Identifier	\$10
Horsemen's Bookkeeper	\$10
Horse Owner	\$10
Jockey	\$10
Jockey Agent	\$10
Lease	\$25
Licensee-Administrative Employee	\$10
Licensee-Marketing Employee	\$10
Licensee-Medical Employee	\$10
Licensee-Operations Employee	\$10
Licensee-Plant Employee	\$10
Licensee-Staff Employee	\$10
Mutuel Clerk	\$10
Mutuel Manager	\$10
Night Watchman	\$10
Other	\$10
Outrider	\$10
Paddock Judge	\$10
Partnership	\$25
Patrol Judge	\$10
Photo-Finish Camera Operator	\$10
Placing Judge	\$10
Pony Rider	\$10
Program Director	\$10

Racing Secretary	\$10
Security Officer	\$10
Stable Name	\$25
Stall Superintendent	\$10
Starter	\$10
Timer	\$10
Track Superintendent	\$10
Trainer	\$10
Valet	\$5
Veterinarian (Licensee)	\$10
Veterinarian (Private Practice)	\$10
Video Patrol Personnel	\$10

11 VAC 10-60-20. Practicing veterinarian.

A. Qualifications. A holder of a permit allowing the person to participate as a practicing veterinarian *in Virginia* shall possess a full and unrestricted license from the Virginia Board of Veterinary Medicine.

B. Prohibitions. A practicing veterinarian shall be prohibited from engaging in the following activities:

1. Owning, directly or indirectly, entirely or a portion of any horse racing at the race meeting where he is practicing veterinary medicine;
2. Wagering on the outcome of any race, either directly or indirectly, at the race meeting where he is practicing veterinary medicine; and
3. Furnishing any injection device, injectable substance or any other medication to another permit holder without the written permission of the stewards.

C. Duties. In the exercise of his duties, the practicing veterinarian shall:

1. Treat all horses under his care in a humane manner and report all instances of animal abuse or neglect immediately to the stewards;
2. Report immediately to the commission veterinarian and stewards any illness in a horse presenting unusual or unknown symptoms;
- ~~3. Submit daily written reports to the commission veterinarian of any treatment or medication prescribed or administered to a horse and the reports shall include the name of the horse, its trainer, the treatment performed, medication prescribed or administered, the dosage, and time and date of administration;~~
3. Retain duplicate copies of bills or statements issued to trainers or owners for at least one year;
- ~~4. Make available to the commission veterinarian, stewards or other commission personnel, upon request, copies of any written records or billing to trainers or owners; and~~
5. Use only single-use disposable syringes and infusion tubes, and whenever using a hypodermic needle or syringe, the practicing veterinarian shall destroy the needle and syringe and remove it from the enclosure.

11 VAC 10-60-30. Pharmaceutical representative. (Repealed.)

~~A person shall submit an application to participate in horse racing as a pharmaceutical representative. A pharmaceutical representative may sell only those substances authorized by the Virginia Drug Control Act (§ 54.1-3400 et seq. of The Code of Virginia) and horse care products within the enclosure. A pharmaceutical representative shall submit a list of all medications or preparations to the commission veterinarian for approval prior to their sale, and sell only those approved by the commission veterinarian. The pharmaceutical representative shall only sell medications and preparations to practicing veterinarians and vendors of horse care products, and shall not sell, either directly or indirectly, to other permit holders.~~

11 VAC 10-60-40. Horse owner.

A. Generally. No horse may start in a race at a race meeting licensed by the commission unless the owner, or part owner who has an interest of 5.0% or more in the horse, has been issued a permit by the commission, or unless an application has been submitted by the owner or part owner, or by their trainer or authorized agent, and the approval of the stewards has been obtained. If the trainer or authorized agent submits a partially completed application on behalf of an owner, the applicant shall complete the application within 30 days. The applicant shall be subject to disciplinary action for failure to complete the application. In any event, all purse moneys earned shall be held until the application is completed.

B. Husband and wife. For the purposes of these regulations, a husband and a wife *who enter their horse or horses as a single entity* shall not be considered a partnership ~~when they enter their horse or horses as a single entity. However, a husband and wife~~ but shall make separate applications for permits as owners.

C. Registration of ownership. ~~Every certificate of registration or eligibility paper shall reflect the true ownership of the horse. The true ownership of the horse shall be listed by the trainer with the racing secretary and the ownership of the horse printed in the daily program shall conform to the ownership listed on the certificate of registration or eligibility paper with the racing secretary.~~

1. ~~Before a horse can start in a race, its true ownership must be recorded the trainer must list its ownership with the racing secretary and the appropriate breed registry, e.g., thoroughbred: The Jockey Club; standardbred: United States Trotting Association; quarter horse: American Quarter Horse Association; and arabian: Arabian Horse Registry of America;~~
2. In the event ownership of a horse is a syndicate, corporation, partnership or other joint venture, the name of the *managing owner*, ~~which is shall be printed in the daily program, shall be the person designated as the managing owner;~~ and
3. In the event of a change in ownership of a horse, it shall be the responsibility of the new owner to record the

~~change in ownership with the racing secretary and the appropriate breed registry.~~

D. Qualifications of owners. In addition to all of the qualifications applying to all applicants in these regulations, applicants for permits as horse owners shall meet the following additional requirements:

1. Shall be 18 years old or older, if a natural person;
2. Shall present a copy of a declaration page or certificate of insurance for workers' compensation as required by these regulations; *and*
3. Shall own or have under lease a horse eligible to race and shall be able to prove ownership of a horse eligible to race to the satisfaction of the stewards; *and*.
4. ~~Shall designate in writing a trainer who will have care and supervision for each horse.~~

E. Disclosure of ownership. ~~All holders of permits allowing them to participate in horse racing as owners shall make full disclosure of the entire ownership of each horse owned by them, and the Trainers shall be held jointly responsible for the full disclosure of ownership of all horses under their care to the racing secretary. This disclosure shall be in writing and include:~~

1. All persons, who directly or indirectly, through lien, lease, partnership, corporate stockholding, syndication, or other joint venture, hold any present or reversionary right, title, or interest in the horse; *and*
2. All persons who by virtue of any form of ownership interest might exercise control over the horse or derive benefit from the racing of the horse as well as the degree and type of ownership held in the horse; *and*.

~~3. The full disclosure shall be made to the racing secretary, with a copy submitted to the stewards, upon the horse's arrival within the enclosure or at the time of entry, whichever event occurs first, and the racing secretary and stewards shall be notified immediately upon any subsequent change in ownership.~~

F. Joint ownership. No more than five persons may be ~~issued permits listed~~ as owners of a single horse. In the event more than five persons own interests in a single horse, through partnership, corporation, syndication or other joint venture, the owners shall designate, in writing, a member of the partnership, corporation, syndication or joint venture to represent the entire ownership and be responsible for the horse as the managing owner. Before the horse may be entered to race, the following requirements must be met:

1. A written designation of a managing owner to represent the entire joint venture must be submitted to the ~~stewards~~ *racing secretary* and signed by every person having an interest of 5.0% or more in any horse entered to race, the chief executive officer of any corporation involved, and the general partner of any limited partnership;

Proposed Regulations

2. Each person having an interest of 5.0% or more in a horse shall apply for a permit as an owner;

3. Each person having an interest of less than 5.0% need not apply for a permit as an owner, unless he intends to participate at the race meeting; however, a complete list of names and addresses of persons having an interest of less than 5.0% shall be provided to the stewards for their approval; and

4. A horse shall not be entered where a person, who has any ownership interest in the horse, would be ineligible for a permit under these regulations.

G. Estates, partnerships, corporations and other legal entities. Every estate, partnership, corporation and other legal entity shall make application for a permit to the commission and all ~~parties to persons having a 5.0% or more ownership interest in the estate, partnership, corporation or legal entity~~ shall also make application to the commission for permits as owners.

1. A written designation of a managing owner to represent the estate, partnership, corporation or other legal entity must be submitted to the stewards and signed by every person having an interest of 5.0% or more in any horse entered to race, by the chief executive officer of any corporation involved, and by the general partner of any limited partnership;

2. The managing owner shall be responsible for submitting to the stewards a copy of the partnership papers or articles of incorporation which shall ~~including~~ include the following information:

a. The name or names of the horse or horses involved in the estate, partnership, corporation or other legal entity;

b. The name and address of every person having any interest in the horse or horses involved in the estate, partnership, corporation or other legal entity;

c. The relative proportions of such interests;

d. In whose name the horse or horses shall run, and whose name shall be printed in the daily program;

e. The person who may enter the horse in races *if other than the trainer*;

f. The terms of any contingency, lease or any other arrangement; and

g. All partnership papers, articles of incorporation or other appropriate documents must be signed by all parties to the estate, partnership, corporation or other legal entity.

3. All parties in the estate, partnership, corporation or other legal entity shall be jointly and severally liable for all stakes, fees and other obligations.

H. Leases. When a horse is held under a lease, the lease agreement must be submitted to the stewards for their approval, and when approved by the stewards, the lease

shall be attached to the certificate of foal registration or eligibility certificate. Before the stewards may approve a lease agreement, the following conditions must be fulfilled:

1. The lessee is a permit holder as an owner;

2. The lessor is eligible for a permit;

3. The signatures of the lessors and lessees on the lease agreement are subscribed and sworn to before a notary public;

4. The term of the lease is not less than one year, unless sooner terminated by claim or retirement of the horse;

5. The conditions of the lease specify whether the horse can be entered in a claiming race, and if so, the minimum price for which the horse can be entered, and the name of the payee in the event the horse is claimed;

6. The conditions of the lease specify that upon the horse being claimed, the lease shall terminate and all rights to the horse shall pass to the claimant as a bona fide purchaser;

7. The conditions of the lease divest lessors or sublessors of control or direction of the racing performance of the horse while held under the lease agreement; and

8. The program listing of the lessee would not mislead the public by reason of the absence in the daily program of the name of a person or persons possessing a beneficial interest in the horse.

I. Stable names. A holder of a permit as an owner may register a "stable name" with the commission. All names that do not reveal the actual identity or identities of the owner or owners of the horse or horses shall be considered stable names. The following conditions shall apply to stable names:

1. In making an application for a stable name, the applicant shall make a full disclosure of all of the parties to the stable name regardless of the proportion of their interest;

2. All parties, who have an interest of 5.0% or more, in the stable name must be holders of permits as owners;

3. If a partnership or corporation is involved in the stable name, then all of the provisions of these regulations applicable to partnerships or corporation must be complied with as well;

4. Any changes in the parties to the stable name must be reported to the racing secretary and the stewards prior to the horse being entered;

5. Any person, who has been a party to a stable name, may cancel his participation in the stable name upon giving a notarized statement to the stewards and racing secretary, and the notice must be received before time ~~of~~ of entry;

6. A stable name shall not be used that is identical to one registered with the commission or with The Jockey Club, the National Steeplechase Association, the United

States Trotting Association or the American Quarter Horse Association;

7. A stable name shall not be used which is the name of another owner of horses or the name of another prominent person;

8. A trainer may use a stable name only if he is a party to the stable name and trains all of the horses racing under the stable name;

9. The stable name must be clearly distinguishable from other stable names, and when appearing in the daily program, the stable name must be accompanied by the legal name of owner. If the stable name has more than one owner, one legal name of a party to the stable name must appear followed by the term "et al";

10. A corporate name may be used as a stable name, but under no circumstances shall a stable name be used for advertising purposes; and

11. A stable name may be canceled when all parties to the stable name submit to the stewards and racing secretary written notice of the cancellation, and a stable name may be changed by registering a new stable name with the commission.

J. Racing colors. For thoroughbred, jump steeplechase and other flat races, a holder of a permit as an owner shall register a set of racing colors when submitting an application for an owner's permit. The following provisions shall regulate the registration of racing colors:

1. Owners shall be responsible for designing and providing racing colors, consisting of jackets and caps of distinctive colors and patterns, to be worn by jockeys during a race;

2. Racing colors shall be registered annually by the owner;

3. Racing colors that are not readily distinguishable from those already registered by the commission or from those already registered with The Jockey Club or the National Steeplechase Association shall be prohibited;

~~4. Racing colors including advertising, promotional, cartoon symbols or words are prohibited;~~

~~5.~~ 4. No jockey may wear the racing colors except those registered by the owner; however, in emergency situations, the jockey may wear substitute racing colors with the permission of the stewards; and

~~6.~~ 5. Owners and trainers shall be jointly responsible for providing the clerk of scales with racing colors that are neat, clean and in good repair.

K. Registration requirements. No owner may start his horse in any race unless the certificate of registration or eligibility certificate has been presented to the racing secretary, and the registration documents are properly completed showing the name, color, sex, age, pedigree and true ownership of the horse.

~~L. Change of trainer. An owner may make a change in a trainer of his horse or horses upon the submission of a written notice to the stewards and the racing secretary.~~

~~M. L. Prohibitions on owners. No owner shall enter a horse that is ineligible. Only a practicing veterinarian possessing the appropriate permit may treat a horse that is entered in a race on which pari-mutuel wagering shall be conducted.~~

11 VAC 10-60-60. Bloodstock agent. (Repealed.)

~~A person shall submit an application for a permit to participate in horse racing as a bloodstock agent who for gain, gratuity, commission or reward in either money or goods, acts as an agent for the sale or purchase of any horse, which is not his own, stabled within the enclosure and eligible to race at a meeting licensed by the commission. The following provisions shall apply to bloodstock agents:~~

~~1. All bloodstock agents shall apply for the appropriate permit before participating in any transaction involving a horse stabled within the enclosure and eligible to race;~~

~~2. A bloodstock agent who participates in a transaction where any warranty of soundness, condition or racing ability is expressed or implied shall submit to the stewards, within five days of the date of the sale, a written statement of the warranty setting forth the warranties expressed or implied, and signed by the seller and buyer or by the bloodstock agents acting on their behalf;~~

~~3. A bloodstock agent who participates in a transaction, which includes any lien upon the horse, shall file a written statement within five days of the sale with the stewards; and~~

~~4. No bloodstock agent shall either misrepresent any material fact, nor withhold any material fact which he knows, from any person connected with the sale of a horse or misrepresent his personal interest in any horse.~~

11 VAC 10-60-70. Trainer.

A. Generally. No horse may be entered to race at a race meeting licensed by the commission unless the horse is under the care and supervision of a person holding a permit from the commission as a trainer. A trainer may represent the owner in entering of a horse, declaring the horse out of a race or retaining a jockey.

B. Qualifications. A permit may be issued to a person to participate in horse racing as a trainer, if the person possesses a currently valid permit as a trainer in *Virginia* or another jurisdiction or if the person satisfactorily completes a trainer's test, administered under the supervision of the stewards. A person shall not be issued a permit as a trainer unless he meets the following requirements:

1. The person must be 18 years old or older;

~~2. Shall present a copy of the declaration page or certificate of insurance for workers' compensation as required by these regulations. If the applicant for the permit is subject to the compensation provisions of the~~

Proposed Regulations

Virginia Workers' Compensation Act (§ 65.2-100 et seq. of the Code of Virginia), he must submit proof of his compliance with the insurance and self-insurance provisions of that Act with his application for the permit;

3. The person must be qualified by experience or competence to care for and train racehorses; and
4. The person must have in his charge a horse eligible to race.

C. Trainer's test. The stewards may require any person, whether or not he holds a currently valid permit ~~from the commission in Virginia~~ or another jurisdiction as a trainer, to satisfactorily complete a trainer's test to demonstrate that he is qualified by experience or competence to care for and train racehorses. The test shall consist of a written test administered by the stewards and a barn test administered by representatives of the horsemen, under the supervision of the stewards.

D. Prohibitions. A holder of a permit ~~allowing the person to may not~~ participate in horse racing as a trainer ~~is prohibited from also participating in horse racing and as a jockey or apprentice jockey with the exception of jump races,~~ jockey agent, veterinarian, veterinarian's assistant, ~~equine dentist,~~ farrier, or farrier's assistant, ~~or as an employee of the licensee.~~ In addition, a trainer:

1. Shall not train horses under an assumed name or stable name; and
2. Shall not engage in any activity, directly or indirectly, involving the care, supervision or racing of horses other than those he has registered with the racing secretary as being in his charge.

E. Suspension. All horses in the charge of a trainer whose permit is suspended for more than 10 days or revoked shall not be allowed to race. When a trainer's permit is suspended or revoked, it shall be the responsibility of the owners of the horses to designate in writing to the stewards to whom the responsibilities for training the horses shall be transferred. This written notice shall be presented to the stewards for approval. The stewards, in their discretion, may withhold approval of a transfer of horses to another trainer, if they believe that the transfer of the horses to another trainer would in any way circumvent the intent of the ruling of the commission.

F. Duties. A person holding a permit allowing him to participate in horse racing as a trainer shall be responsible for the proper care, health, training, safety and protection of horses under his care against administration of all substances foreign to the natural horse, except those specifically permitted by the regulations of the commission. In the exercise of his duties, a trainer shall:

1. Register with the stewards all persons in his employ and ensure that all of his employees have made application for the appropriate permits from the commission ~~within 24 hours of arriving within the enclosure or being employed;~~

2. Promptly notify the stewards and the licensee's director of security of any employee he discharges;

~~3. Provide workers' compensation insurance coverage for all of his employees. Comply with the insurance and self-insurance provisions of the Virginia Workers' Compensation Act (§ 65.2-100 et seq. of the Code of Virginia) if he is subject to the compensation provisions of that Act;~~

4. Register all horses in his charge and present to the racing secretary the certificates of registration, certificates of eligibility or other registration documents;

5. Enter horses, with the permission of the owner, and bear primary responsibility as to the horse's eligibility, weight allowances, racing fitness, proper shoes, bandages, and other equipment;

6. Ensure that the horse is in the paddock at the time prescribed by the stewards;

~~7. Be responsible, jointly with the owner, for horses he enters as to stakes payments and jockey fees due;~~

~~8. 7. Furnish the name of the jockey engaged to ride the horse, if possible, at time of entry, but in no event later than scratch time at the time designated by the racing secretary;~~

~~9. 8. Attend the horse in the paddock and supervise the saddling of the horse, and in his absence, provide an assistant trainer or other trainer to attend the saddling of horses and assume responsibility for the horses already entered;~~

~~10. 9. Witness himself, or assign one of his employees to witness, the collection of samples of blood, urine, or other bodily substances in the ~~detention~~ test barn;~~

~~11. 10. Maintain the stable area assigned to his horses in a neat, clean and sanitary condition at all times, and ensure that all fire prevention measures are taken; and~~

~~12. 11. Report promptly to the commission veterinarian any serious illness or death of a horse in his charge.~~

G. Standardbred trainer. A permit may be issued to a person desiring to participate in horse racing as a trainer of Standardbreds, if the person possesses a currently valid trainer's *permit in Virginia* or license from the United States Trotting Association.

H. Steeplechase trainer. A permit may be issued to a person desiring to participate in horse racing as a trainer of horses utilized in ~~jump~~ *steeplechase* races, if the person possesses a currently valid trainer's license issued by the stewards of the National Steeplechase Association or a currently valid permit as a trainer of horses utilized in ~~jump~~ *steeplechase* races in *Virginia* or another jurisdiction.

I. Substitute trainer. When a trainer is absent from his stable or the enclosure and a horse under his care is scheduled to race, he must provide a licensed trainer or assistant trainer to assume joint responsibility for the horses he is training. The substitute trainer or assistant trainer shall

sign, in the presence of the stewards, a statement accepting responsibility for those horses.

J. Assistant trainer. A person holding a permit allowing him to participate in horse racing as a trainer may employ an assistant trainer with the approval of the stewards. Any assistant trainer shall be qualified to assume the duties and responsibilities imposed upon the holder of a trainer's permit, and the trainer shall be jointly responsible for the assistant trainer's acts and omissions involving racing matters and this chapter.

K. Trainer responsibility. The trainer shall be the absolute insurer of, and responsible for, the condition of each horse he enters in a race, regardless of the acts of third parties. A trainer shall not start a horse or permit a horse in his custody, care or control to be started if he knows, or through the exercise of reasonable care he might have known or has cause to believe, that the horse has received a substance foreign to the natural horse, except those specifically permitted by the regulations of the commission. The trainer shall guard, or caused to be guarded, each horse in his charge in a manner and for a period of time before racing so as to prevent any person from administering a substance foreign to the natural horse, except those specifically permitted by the regulations of the commission.

11 VAC 10-60-120. Jockey.

A. Generally. A person shall submit an application to participate in horse racing as a jockey. The applicant shall submit to the stewards sufficient evidence that he is either a journeyman or apprentice jockey in *Virginia* or another jurisdiction and demonstrates sufficient horsemanship to ride in a race without jeopardizing the safety of horses or other jockeys.

B. Examinations. A jockey may be required to take a physical examination from a physician appointed by the stewards to establish that he possesses the physical ability to safely ride in races. A jockey may also be required to take an eye examination from a physician appointed by the stewards to establish he has eyesight sufficient to safely ride in races.

~~C. Prohibitions. A jockey or apprentice jockey may not be an owner or trainer of any racehorse with the exception of horses starting in jump races.~~

~~D. C. Apprentice jockey. If the person does not possess a currently valid permit from in *Virginia* or another jurisdiction as an apprentice jockey or, has not ridden satisfactorily in three races at a pari-mutuel meeting, or has never held a thoroughbred journeyman jockey permit, then the stewards may allow the person to ride probationary mounts in three races at a race meeting licensed by the commission under the following conditions:~~

1. That he is at least 16 years old;
2. That he has ~~been employed~~ held a permit for at least one year as an exercise rider under the supervision of a person holding a permit as a trainer;

3. A trainer submits a notarized statement to the stewards that the person has been employed by him and has demonstrated sufficient horsemanship to be allowed to ride in three races at a race meeting licensed by the commission;

4. The starter has schooled the person from the starting gate with other horses and approves the person as capable of breaking a horse properly from the starting gate;

5. The stewards retain sole discretion of whether or not the person possesses the physical ability and has demonstrated sufficient horsemanship to ride in a race without jeopardizing the safety of horses or other jockeys; and

6. The stewards, in their discretion, may at any time deny the person the opportunity to ride in more races for cause.

If the person possesses a currently valid permit from another jurisdiction as an apprentice jockey or has ridden satisfactorily in three races at a pari-mutuel meeting, then the person must submit sufficient evidence to the stewards:

- a. That he is at least 16 years old;
- b. That he has ridden satisfactorily in at least three races at a pari-mutuel meeting; and
- ~~c. That he has been employed for at least one year under the supervision of a person holding a permit as a trainer; and~~
- ~~d.~~ c. That he has demonstrated to the stewards sufficient horsemanship to ride in a race without jeopardizing the safety of horses or other jockeys.

~~E. D. Amateur jockey. A permit may be issued to a person desiring to participate in horse racing as an amateur jockey. The person shall compete on even terms when riding against professional jockeys, but he shall not accept any fees or gratuities. The person must meet all of the requirements for an apprentice jockey, and his amateur status must be noted on the program.~~

~~F. Jump E. Steeplechase jockey. A permit may be issued to a person desiring to participate in horse racing as a jockey riding horses in jump steeplechase races. A person shall submit an application for the appropriate permit, meet all of the requirements pertaining to holders of permits as jockeys, and hold a currently valid license issued by the stewards of the National Steeplechase Association.~~

~~G. F. Foreign jockey. Whenever a jockey from a foreign country, excluding Mexico and Canada, rides in the United States, he must submit an application for a permit and declare that he is a holder of a valid permit and currently not under suspension. To facilitate this process, the jockey shall present a declaration sheet stating:~~

1. That he is the holder of a valid permit to ride;
2. That he is not currently under suspension; and

Proposed Regulations

3. That he agrees to be bound by the rules and regulations of the jurisdiction in which he is riding.

This sheet shall be retained by the stewards and at the conclusion of the jockey's participation in racing, it shall be returned to the jockey, properly endorsed by the stewards, stating he has not incurred any penalty or had a fall. If a penalty has been assessed against the jockey, the stewards shall notify the racing authority issuing the original permit to extend the penalty for the same period of time.

~~H. G. Apprentice allowance. An apprentice jockey or jockey riding probationary mounts may claim in all overnight races, except handicaps, a five-pound apprentice allowance. The jockey may claim the five-pound apprentice allowance for a period of one year from the date he rides his fifth winner. He shall be entitled for the five-pound apprentice allowance beyond the one-year limit until he rides a total of 45 winners. However, he shall not be entitled to the five-pound apprentice allowance beyond two years from the date of riding his fifth winner.~~ *may claim the following weight allowances in all overnight races except stakes and handicaps:*

1. A 10-pound allowance beginning with the first mount and continuing until the apprentice has ridden five winners.

2. A seven-pound allowance until the apprentice has ridden an additional 35 winners.

3. If an apprentice has ridden a total of 40 winners prior to the end of a period of one year from the date of riding his fifth winner, he shall have an allowance of five pounds for one year from the date of the fifth winning mount.

4. If, after a period of one year from the date of the fifth winning mount, the apprentice jockey has not ridden 40 winners, the applicable weight allowance shall continue for one more year or until the apprentice rides his 40th winning mount, whichever comes first. But in no event may a weight allowance be claimed for more than two years from the date of the fifth winning mount, unless an extension has been granted under the provisions of this regulation.

5. An apprentice who possesses a contractual agreement may claim an allowance of three pounds for an additional one year when riding horses owned or trained by the original contract employer.

~~I. H. Extension of apprentice allowance. The stewards, in their discretion, may extend the apprentice allowance because of time lost by disability arising out of an accident and injury incurred while plying his trade or by military service, disabling illness or restrictions on horse racing. In order to qualify for the extension, he shall have been rendered unable to ride for a period of not less than 14 consecutive days during the period in which he was entitled to an apprentice allowance. The commission or its designee may extend the weight allowance of an apprentice jockey when an apprentice jockey is unable to continue riding due to~~

(i) physical disablement or illness, (ii) military service, (iii) attendance in an institution of secondary or higher education, (iv) restriction on racing, or (v) other valid reasons.

1. *In order to qualify for an extension, an apprentice jockey shall have been rendered unable to ride for a period of not less than seven consecutive days during the period in which the apprentice was entitled to an apprentice weight allowance. Under exceptional circumstances, the commission or its designee will give consideration to the total days lost collectively.*

2. *The commission or its designee shall have the authority to grant an extension to an eligible applicant, but only after the apprentice jockey has submitted documentation to them verifying the days lost as defined by this regulation.*

3. *An apprentice jockey may petition the commission or its designee for an extension of time for claiming apprentice weight allowances, and the apprentice jockey shall be bound by the decision of the commission or its designee. If the apprentice jockey has been denied an extension in another jurisdiction, the commission or its designee shall deny the application for an extension.*

~~J. I. Jockey contracts. An apprentice jockey may enter into a contract with an owner or trainer, who holds an appropriate permit issued by the commission, for a period not less than three years nor more than five years. The following provisions shall apply to contracts for apprentice jockeys:~~

1. The original contract is to be submitted to the stewards with copies made available to the parties to the contract;

2. A written extension may be made to a contract, if the original was for less than five years;

3. The original contract shall be kept in full force and in effect throughout its contract period. Any and all amendments to the contract shall be made a part of and either added to or attached to copies in the possession of the parties and a copy of the amendments submitted to the stewards;

4. An owner or trainer may not enter into a contract with an apprentice jockey unless he has control or possession of a stable of horses as would, in the discretion of the stewards, warrant the employment of an apprentice;

5. An apprentice jockey may not acquire his own contract;

6. All apprentice jockey contracts must be submitted to the stewards within 30 days of their execution or upon filing an application for a permit;

7. The contract shall provide for fair remuneration, adequate medical attention, suitable board and lodging, workers' compensation insurance coverage, and provision for conserving the savings out of the earnings of the apprentice; and

8. Any apprentice or contract rider shall be entitled to the regular jockey fees, except when riding a horse owned in part or solely by his contract holder. An interest in the winnings only, e.g., a trainer's commission, does not constitute ownership.

~~K. J. Apprentice certificate. An apprentice jockey may be granted an apprentice certificate issued by the stewards commission or its designee, in lieu of a traditional apprentice contract. The apprentice certificate shall be for three years, from the date of issuance, and shall grant to an apprentice all allowances and conditions that are granted to an apprentice jockey who is under contract. An apprentice jockey who loses his weight allowances shall obtain a jockey permit before being permitted to ride again.~~

~~L. K. Restrictions of jockeys under contract. Any apprentice or journeyman jockey, who is under a contract to an owner or trainer, shall not:~~

- ~~1. Ride any horse not owned or trained by his contract employer in a race against a horse owned or trained by his contract employer;~~
- ~~2. Ride or agree to ride any horse in a race without consent of his contract employer; and~~
- ~~3. Share any money earned from riding with his contract employer; and.~~
- ~~4. Accept any present, money or reward of any kind in connection with his riding of any race except through his contract employer.~~

~~M. L. Calls and engagements. Any jockey, who is not prohibited by a contract, may agree to give first or second calls on his services to any owner or trainer. If the agreement is for more than 30 days, then the agreement must be in writing and a copy of the agreement submitted to the stewards for approval. Any jockey employed by an owner or trainer on a regular salaried basis may not ride against the stable. No owner or trainer shall employ or engage a jockey to prevent him from riding another horse.~~

~~N. M. Naming of jockeys. A jockey shall be named to ride a horse in a race no later than scratch time of the day of the race at a time designated by the racing secretary, and a subsequent change of a jockey shall be approved by the stewards. The following provisions shall apply to the naming of a jockey:~~

- ~~1. After a jockey gives a call to ride a horse in a race, either personally or through his agent, and fails to fulfill the engagement, he shall not accept another engagement in that race or be assigned by the stewards to another horse in that race;~~
- ~~2. In races where a jockey has more than one engagement, the jockey agent shall be requested to specify a first and second call on the jockey's services; and~~
- ~~3. A jockey may be named on no more than two horses in the body of a race and named on no more than three~~

~~horses including "also eligibles," scheduled for the dirt surface.~~

~~O. N. Fee earned. A jockey's fee shall be considered earned when the jockey is weighed out by the clerk of scales. The fee shall not be considered earned if the jockey, of his own free will, takes himself off of his mount, where injury to the horse or rider is not involved. Any conditions or considerations not covered by the above regulation shall be at the discretion of the stewards.~~

~~P. O. Multiple engagements. If any owner, or his trainer or authorized agent, engages two or more jockeys after scratch time to ride the same horse in the same race after the time designated by the racing secretary to name jockeys, the owner shall pay the unplaced fee to the jockey not riding his horse in the race jockey taken off the horse a matching fee equal to that earned by the jockey who rode the horse. No owner shall be held liable for multiple engagements where such engagements are the results of actions taken by jockeys or their agents. An owner or trainer who elects to remove a jockey from his mount after the time designated by the racing secretary for naming jockeys may be subject to disciplinary action by the stewards.~~

~~Q. P. Duty to fulfill engagements. A jockey shall fulfill his duly scheduled riding engagements, unless excused by the stewards. No jockey shall be forced to ride a horse he believes to be unsound or over a racing surface that he believes to be unsafe. If the stewards find that a jockey's refusal to fulfill a riding engagement is unwarranted, then the jockey may be subject to disciplinary action.~~

~~R. Q. Presence in jockey room. A jockey, who has an engagement to ride in a race, shall report his weight and be physically present in the jockeys' room at a time appointed by the stewards, unless excused by the stewards, and upon arrival shall report all of his engagements for the program to the clerk of scales. The following provisions shall apply:~~

- ~~1. In the event a jockey does not report to the clerk of scales at the appointed time, the clerk of scales shall advise the stewards who may name a substitute jockey and any substitution shall be publicly announced prior to the opening of wagering;~~
- ~~2. After reporting to the clerk of scales, a jockey shall remain in the jockeys' room until he has fulfilled all of his engagements for the program. A jockey may only leave to ride in a race or to view the races from a location approved by the stewards;~~
- ~~3. A jockey shall have no communication with any person outside the jockeys' room other than an owner or trainer for whom he is riding, a racing official, his jockey agent or a representative of the media; and~~
- ~~4. A jockey, who intends to discontinue riding at a race meeting prior to its conclusion, shall notify the stewards no later than upon fulfilling his final engagement of the day he intends to depart.~~

~~S. R. Attire. A jockey shall wear traditional attire and shall be neat and clean in appearance. A jockey shall wear the~~

Proposed Regulations

cap and jacket in the owner's racing colors, white breeches, top boots, protective helmet, *safety vest which meets the minimum specifications as defined by the British Equestrian Trade Association*, and a number on his right shoulder corresponding to the horse's number as shown on the saddle cloth and daily program.

~~F.~~ S. Weighing out. A jockey shall report to the clerk of scales for weighing out, not more than one hour and not less than 15 minutes before post time for each race in which he is engaged to ride, and at the time of weighing out shall declare overweight, if any. The following provisions shall apply to weighing out:

1. A jockey shall not carry more than ~~one pound two pounds~~ of overweight; without the consent of the owner or trainer of the horse which he is engaged to ride; however, a jockey shall not carry more than ~~five seven~~ pounds of overweight;
2. ~~Whip, blinkers, number cloth, bridle, goggles and protective helmet~~ *Bit, blinkers, bridle, number cloth, reins, safety helmet, safety vest, whip, goggles, overgirth, chamois and breastplate* shall not be included in a jockey's weight;
3. All overweights shall be promptly reported to the stewards; and
4. No horse shall be disqualified because of overweight carried.

~~U.~~ T. Weighing in. Following the completion of the race, a jockey shall ride his horse to the ~~finish, salute the stewards before dismounting,~~ *designated area, salute the stewards, dismount*, remove from the horse his equipment, without assistance, which is to be included in a jockey's weight, and move ~~promptly directly~~ to the scales where he may be weighed in by the clerk of scales. No person shall throw any covering over any horse until a jockey has removed from the horse his equipment which is to be included in a jockey's weight. Due to injury to either horse or jockey, the stewards may excuse the jockey from weighing in. ~~A jockey shall weigh out and weigh in at the same weight~~ *No jockey shall weigh in at more than four pounds over the weight at which he weighed out*, unless affected by the elements.

~~V.~~ U. Wagering. A jockey may only have a wager placed for him through an owner or trainer of the horse he is riding in the race, and the jockey's wager shall only be on his horse to win. The owner or trainer placing the wager shall keep precise records of all wagers placed for a jockey and the record shall be available to the stewards upon request.

~~W.~~ V. Viewing films. ~~A jockey shall be responsible for checking the film list posted by the stewards in the jockeys' room the day after riding in a race.~~ *The stewards shall attempt to notify all jockeys who are requested to attend the reviewing of the films, and their names shall be posted on the film list.* A jockey, whose name is on the film list, shall be present at the designated time and place to view the films of the race, *unless excused by the stewards.* A jockey may be accompanied by a representative of his choosing.

~~X.~~ Jockey suspensions. ~~The stewards, with the approval of the commission, may designate the stakes races, futurities or other special events at the race meeting in which a jockey will be permitted to compete, notwithstanding the fact that the jockey is under suspension for 10 days or less for a riding infraction at the time the designated race is to be run. The following provisions shall apply:~~

1. ~~The ruling issued by the stewards for jockeys shall state: "The term of this suspension shall not prohibit participation in designated races;"~~
2. ~~A listing of the designated races shall be posted in the jockeys' room, the racing secretary's office and any other place deemed appropriate by the stewards;~~
3. ~~A suspended jockey must be named at time of entry to participate in any designated race; and~~
4. ~~A day in which a jockey participated in one designated race while under suspension shall count as a suspension day.~~

~~W.~~ Designated races. *A jockey who is serving a suspension of 10 days or less will be permitted to ride in a designated race during the suspension if:*

1. *The race has been specified as a designated race by the racing secretary before opening day of the race meeting.*
2. *The race has been approved as a designated race by the stewards.*
3. *The jockey is named not later than at the time designated by the racing secretary.*
4. *The jockey agrees to serve an additional day of suspension in place of the day on which the jockey rides in a designated race.*

Reciprocity of this regulation will apply only to those jurisdictions which have adopted the designated race regulation.

11 VAC 10-60-130. Jockey agent.

A person shall submit an application to participate in horse racing as a jockey agent. The jockey agent acts as an agent for the jockey he represents in securing riding engagements. The stewards, in their discretion, may ask a person to take a written or oral examination to determine his fitness to participate in horse racing as a jockey agent. In addition to all of the requirements imposed upon all holders of permits, the following shall apply to jockey agents:

1. A jockey agent shall designate in writing those jockeys for whom he is making engagements;
2. A jockey agent shall have in his possession at all times an engagement book, approved by the stewards, and all engagements made for a jockey by the agent shall be recorded in the book. The book shall be presented to the stewards upon request;

- 3. A jockey agent shall not make or assist in making of any engagement for a jockey other than those he has designated in writing;
- 4. A jockey agent may make engagements for only two jockeys, one of which must be an apprentice jockey;
- 5. A jockey agent may make engagements for two journeyman jockeys only with the permission of the stewards;
- 6. If a jockey agent relinquishes the making of engagements for any jockey, the jockey agent shall immediately notify the stewards and clerk of scales and turn over to the stewards a list of any unfilled engagements he may have made for that jockey;
- 7. A jockey agent may give only one "first call" and ~~two "second calls"~~ one "second call" per race for each jockey he represents, and conflicting claims for the services of a jockey shall be decided by the stewards;
- 8. A jockey agent shall be able to explain, to the satisfaction of the stewards, rival claims for the services of a jockey or that the rival claims are the result of bona fide error;
- 9. No jockey shall have more than one agent;
- 10. An owner, trainer or authorized agent may make engagements for an apprentice jockey or jockey; and
- 11. A jockey not represented by an agent may make his own engagements.

11 VAC 10-60-140. Exercise rider.

A person shall submit an application to participate in horse racing as an exercise rider. If the applicant for a permit as an exercise rider is not employed by an owner or trainer or does not possess a similar permit from another jurisdiction, then the stewards may, in their discretion, require the applicant to demonstrate his horsemanship before issuing a permit to the applicant. The exercise rider shall wear a protective helmet and a safety vest which meets the minimum specifications as defined by the British Equestrian Trade Association when exercising horses.

11 VAC 10-60-150. Pony rider.

A person shall submit an application to participate in horse racing as a pony rider. If the applicant for a permit as a pony rider is not in possession of a similar permit from another jurisdiction, then the stewards may, in their discretion, require the applicant to demonstrate his horsemanship before issuing a permit to the applicant. The pony rider shall wear a protective helmet, a safety vest which meets the minimum specifications as defined by the British Equestrian Trade Association, and attire prescribed by the licensee. The attire shall be neat, clean and in good repair.

11 VAC 10-60-290. Clocker.

A person shall submit an application to participate in horse racing as a clocker for flat race meetings. The clocker shall be present at his assigned location at the opening of training

hours each morning and remain there until training hours are concluded. The clockers shall keep a listing of the name of each horse working out, distance, time, manner in which the workout was accomplished, condition of the racing surface, and any other information deemed appropriate. At the conclusion of training hours, the clocker shall submit the listing to the stewards, racing secretary and any other personnel deemed appropriate.

11 VAC 10-60-300. Gap attendant.

A person shall submit an application to participate in horse racing as a gap attendant for flat race meetings. The gap attendant shall be present at his assigned location at the opening of training hours each morning and remain there until training hours are concluded. The gap attendant shall obtain the name of each horse working out, distance, and the starting point and finishing points of the workout, and report this information to the clocker. The gap attendant shall report to the stewards any exercise rider or trainer who refuses to supply this information.

11 VAC 10-60-310. Stall superintendent.

A person shall submit an application to participate in horse racing as a stall superintendent. The stall superintendent shall assist the racing secretary in seeing that the horses are quartered in their assigned stalls, establish a system where horses may not leave or enter the stabling area without the racing secretary's permission, and ensure that the stabling area is maintained in a clean, neat and sanitary condition.

11 VAC 10-60-320. Track superintendent.

A person shall submit an application to participate in horse racing as a track superintendent. The track superintendent shall be (i) responsible for the maintenance of the racing surfaces in a safe and humane condition, (ii) keep written records of the maintenance done on the racing surfaces and present the written records for inspection upon the request of the stewards or commission, and (iii) keep the necessary equipment and personnel to maintain the racing surfaces in a safe and humane condition.

NOTICE: The forms used in administering 11 VAC 10-60-10 et seq., Regulations Pertaining to Horse Racing with Pari-Mutuel Wagering: Participants, are listed below. Any amended or added forms are reflected in the listing and are published following the listing.

FORMS

- Apprentice Jockey Certificate, DLLR/MRC/P/#6/97-786, 9/98.*
- Authorized Agent Form, 9/98.*
- ~~Application for Participant.~~
- ~~Fee Schedule for Permit Holders.~~
- Multi-State Form, 9/98.*
- Racing Commission Permit, 1991.*
- ~~Multiple Participation Form.~~
- ~~Private Practitioner Reporting Form.~~

AUTHORIZED AGENT FORM

Fee: \$10

Date: _____

Dear Sir:

I have this day appointed _____ as an
 whose address is _____
 agent to act for me for the year 19 _____ in all matters pertaining
 to the racing of horses, other than collection of purses and
 moneys due me at race meetings licensed by the Virginia Racing
 Commission.

Owner: _____
 Address: _____
 City, State, Zip: _____

Witness: _____

I further authorize _____ whose
 address is _____ to collect all
 purses and other money due from race meetings licensed by the
 Virginia Racing Commission for the 19 _____ with authority to
 endorse checks from licensees of the Virginia Racing Commission
 payable to me.

Owner: _____
 Address: _____
 City, State, Zip: _____

Witness: _____

State of _____ day of _____
 County or City of _____

I hereby certify that on this _____ day of _____
 before me the subscriber, a notary public of the State of _____
 in and for the _____ aforesaid, personally
 appeared _____ and he made oath in due form
 of law that the matters and facts set forth in the foregoing
 application of appointment are true to the best of his knowledge
 and belief.

AS WITNESS my hand and seal.

_____ Notary Public
 Social Security Number _____

<h2>APPRENTICE JOCKEY CERTIFICATE</h2> <p>ISSUED BY THE VIRGINIA RACING COMMISSION</p>	
Apprentice Name _____	S.S. No. _____
Permanent Address _____	
Date and Place of Birth _____	
Parent or Guardian (if applicable) _____	
Permanent Address (of Parent or Guardian) _____	
Signature of Applicant (Apprentice) _____	
Date Issued _____	Steward's Approval _____
Notary _____	
Apprentice copy - white Steward copy - canary Commission copy - pink	Winning Record on Reverse Side
FORM DLE/RMRC/PW697786	

Original _____ Renewal _____
 MULTI-STATE FORM

FOR COMMISSION USE ONLY

ALL APPLICANTS MUST FULLY COMPLETE THIS ENTIRE PAGE

FORM: DELMAR/CT/PA/VA/97

STANDARDJUREI	OWNER	DE	MD	NJ	NY	PA	VA
THOROUGHBRED	TRAINER						
ARABIAN	ASST TRAINER						
	COLORS REG.						
	STABLE NAME						
	PARTNERSHIP						
	MULTIPLE OWNER						
	CORPORATION						

ALL QUESTIONS MUST BE ANSWERED

1. Has your (or spouse's) license ever been denied, suspended or revoked or is a complaint pending in any racing jurisdiction? YES NO
2. Have you (or spouse) ever been arrested for any crime in which action is still pending (except traffic violations) including driving while intoxicated or vehicular homicide? YES NO
3. Have you (or spouse) been convicted of any crime (except minor traffic violations)? YES NO
4. Are you (or spouse) presently on parole or probation?
5. Have you (or spouse) ever been ruled off, suspended or otherwise barred from participating in racing by any racing organization, commission, or other recognized turf body? If so, state when, where and by whom the ruling(s) were made and the offense(s) charged. YES NO
6. Are you a stockholder in any racing association? YES NO
7. Are you a public employee, an elected public officer, or a political party officer? YES NO
8. Have you had your fingerprints submitted to the F.B.I. YES NO

If yes, when and in what state.

If you answered YES to ANY of questions 1-8 you MUST GIVE COMPLETE DETAILS BELOW. USE EXTRA PAPER IF NEEDED.

DATE OF ISSUE _____
 LICENSE NO. () _____

APPLICANT'S NAME (please print) LAST FIRST MIDDLE

PERMANENT MAILING ADDRESS at which service of all papers may be made upon you

NUMBER AND STREET OR RURAL ROUTE/BOX NUMBER

CITY, TOWN, OR POST OFFICE AND STATE (PROVINCE) POSTAL ZIP COUNTRY

PRESENT ADDRESS

CITY STATE POSTAL ZIP COUNTRY

TELEPHONE - Home _____ Business _____
 Citizen of _____
 Immigrants I.D. No. _____

MAIDEN NAME _____

SOCIAL SECURITY*, FEDERAL IDENTIFICATION OR SOCIAL INSURANCE NUMBER	PLACE OF BIRTH	SEX
U.S.T.A. MEMBERSHIP NUMBER	WEIGHT	HAIR
DATE OF BIRTH	HEIGHT	EYES
How is ownership to be listed in the program:	MARITAL STATUS	Are you married? <input type="checkbox"/> Yes <input type="checkbox"/> No

If applicant is married, please furnish the following information concerning your spouse:

Full Name LAST FIRST MIDDLE (OR JR. etc.)
 Date of Birth _____
 Employer _____
 LICENSING HISTORY

WHEN, WHERE WERE YOU FIRST GRANTED A LICENSE?
 CURRENTLY LICENSED? LAST STATE AND TYPE OF LICENSE

*Voluntary provision of Social Security Numbers is requested and will be used as a secondary identifier for credit, background and other such investigations.

New York Applicable: The authority to request personal information from you, including identifying numbers such as Federal social security and Federal employer identification numbers, and the authority to maintain such information as found in Section 5 of the New York Tax Law. Disclosure of this information by you is mandatory. The principal purpose for which the information is collected is to enable the Department of Taxation and Finance to identify individuals, businesses and others who have been delinquent in filing tax returns or who may have underserved their tax liabilities and to generally identify persons affected by the taxes administered by the Commission of Taxation and Finance. The information will be used for identification and locating purposes and for any other purpose authorized by the New York State Racing and Wagering Board which may include use in a multi-state licensing database. An investigative consumer report may be requested in connection with this application. Your signature authorizes the Racing and Wagering Board to obtain such a report, you may ask in writing whether or not a report was requested and the name and address of the company reporting agency used.

Proposed Regulations

APPLICANTS FOR OWNER'S LICENSE ONLY COMPLETE THE FOLLOWING

Employer's Name: _____
 Employer's Address: _____
 Name of your Bank: _____
 Address of Bank: _____
 How is Ownership to be listed on program? _____
 Who is your Trainer: _____

List all horses owned or leased by you, wholly or in part. Specify lease (L) or purchase (P) in the appropriate space. A copy of the lease agreement(s) must be attached to the application. (Use additional page if necessary.)

HORSE'S NAME	NAME AND ADDRESS OF LESSOR OF THE HORSE OR FROM WHOM PURCHASED	LP

If in co-ownership, (entity fees may apply) list name, license and social security numbers and % ownership held by each.

Name _____ License # _____ SS# _____ % Share _____
 Name _____ License # _____ SS# _____ % Share _____
 Name _____ License # _____ SS# _____ % Share _____

All winnings credited to _____ Lic.# _____ SS# _____
 If incorporated, copy of Cert. of Incorporation must be attached.

Pennsylvania and Virginia Owners Only - Colors Registration

Jacket Color _____ Additional Jacket Description _____
 Sleeves Color _____ Collar Color _____ Cap Color _____

OWNERS AND TRAINERS COMPLETE THE FOLLOWING WORKERS' COMPENSATION INSURANCE

Are you obligated to have Workers' Compensation Insurance covering employees in connection with racing? _____
 If yes, indicate company name _____ Policy Number _____
 Expiration Date _____ Name of Policyholder _____

ASSISTANT TRAINERS COMPLETE THE FOLLOWING

Name of Employer (Trainer) _____

ALL APPLICANTS MUST READ THE FOLLOWING AND SIGN BELOW

In making this application for a license to participate in racing, it is understood that an investigative report may be made whereby information is obtained through personal interviews with third parties, such as family members, business associates, financial sources, friends, neighbors, or others with whom you are acquainted. This inquiry includes information as to your character, general reputation, personal characteristics, and mode of living, which may be applicable. You have the right to make a written request within a reasonable period of time for a complete and accurate disclosure of additional information concerning the nature and scope of the investigation.

By submitting this application I, the undersigned, do hereby (i) agree to abide by the rules and regulations of the state horse racing commission, the laws of the United States of America, state government, municipalities and other subdivisions thereof; and (ii) agree to abide by any provision regarding search and seizure which may be contained in any of the above-mentioned laws, rules and regulations, and I consent and waive any right I have to object in the search, within the grounds of a racing association, of any premises which I may occupy or control or have the right to occupy or control and of my person, property and effects and in the seizure of any article the having of which may be forbidden.

I understand that participation in racing is a privilege, not a right, that any license issued pursuant to this form is subject to condition precedent as set out in the Rules of Racing, and that my failure to comply therewith shall be grounds for immediate voidance or revocation of such license. By acceptance of said license, I agree to abide by the Rules of Racing and rulings or decisions of the Stewards and Judges with the knowledge that rulings or decisions of the Stewards and Judges shall remain in force until reversed or modified only by the authorized regulatory agency.

I hereby certify, under penalty of perjury, that I have read the foregoing form and affirm that every statement contained therein is true and correctly set forth. I do hereby agree that my license may be removed at any time for misstatement or omissions in the foregoing form. I also agree to abide by and obey the rules and regulations and conditions of the authorized regulatory agency in the jurisdictions in which I am granted a license.

I expressly agree to be subject to the subpoena powers of the authorized regulatory agency or a written request issued in lieu of a subpoena and to provide the agency with any and all such information or documents which it may so request. This agreement shall extend to anything which relates to any matter which is the subject of an agency hearing or investigation.

STEWARDS/JUDGES RECOMMENDATION _____ SIGNATURE OF APPLICANT _____ DATE _____

VA.R. Doc. No. R97-248; Filed September 18, 1998, 9:28 a.m.

FINAL REGULATIONS

For information concerning Final Regulations, see Information Page.

Symbol Key

Roman type indicates existing text of regulations. *Italic type* indicates new text. Language which has been stricken indicates text to be deleted. [Bracketed language] indicates a change from the proposed text of the regulation.

TITLE 4. CONSERVATION AND NATURAL RESOURCES

DEPARTMENT OF MINES, MINERALS AND ENERGY

Title of Regulation: **4 VAC 25-150-10 et seq. Virginia Gas and Oil Regulation (amending 4 VAC 25-150-10, 4 VAC 25-150-50, 4 VAC 25-150-60, 4 VAC 25-150-80 through 4 VAC 25-150-130, 4 VAC 25-150-160 through 4 VAC 25-150-360, 4 VAC 25-150-380 through 4 VAC 25-150-460, 4 VAC 25-150-500 through 4 VAC 25-150-530, 4 VAC 25-150-560, 4 VAC 25-150-580 through 4 VAC 25-150-610, and 4 VAC 25-150-650 through 4 VAC 25-150-740; adding 4 VAC 25-150-135, 4 VAC 25-150-435 and 4 VAC 25-150-711; repealing 4 VAC 25-150-70, 4 VAC 25-150-540, 4 VAC 25-150-570, 4 VAC 25-150-640 and 4 VAC 25-150-710).**

Statutory Authority: §§ 45.1-161.3 and 45.1-361.27 of the Code of Virginia.

Effective Date: November 11, 1998.

Summary:

The amendments incorporate recommendations resulting from the Executive Order 15 (94) review, and reflect legislative changes to the Virginia Gas and Oil Act and public comments. The amendments:

- 1. Allow original permits to address plugging of wells, eliminating the need for a later permit modification for plugging;*
- 2. Add flexibility to how the department may handle cases when gas is found in holes not permitted as gas wells;*
- 3. Change some requirements for information in permit applications such as requiring listing the location where spill prevention and countermeasure plans are available instead of providing the plan, and eliminating the regulatory authority for the department to request any other information;*
- 4. Replace prescriptive operating plan requirements with a requirement that operators indicate how the risk to the public safety and to the site and adjacent lands are to be managed consistent with the requirements of the Virginia Gas and Oil Act;*
- 5. Remove the requirement that public advertisements be taken out by companies wishing to transfer permits;*

6. Allow persons to waive the 15-day period in which they may raise objections to permit applications;

7. Clarify the time limits when temporary signs may be used, and eliminate the duplicative requirement for signs when gathering pipelines are in public highway rights-of-way;

8. Change the requirement for backfilling pipeline trenches to allow more than 500 feet of trench to be open for more than 48 hours if ditchline barriers are used for slopes longer than 500 feet;

9. Clarify the standards for quality of water used in drilling wells;

10. Amend the technical requirements to better match accepted, safe industry practices for casing across underground voids, for coal protection strings, and for plugging wells; and

11. Allow wells to be located closer than 200 feet, and gathering pipelines to be located closer than 50 feet, to inhabited buildings when the building owner has given permission and when site conditions warrant permission of a lesser distance.

Summary of Public Comment and Agency Response: A summary of comments made by the public and the agency's response may be obtained from the promulgating agency or viewed at the office of the Registrar of Regulations.

Agency Contact: B. Thomas Fulmer, Department of Mines, Minerals and Energy, Division of Gas and Oil, P.O. Box 1416, Abingdon, VA 24212, telephone (540) 676-5423.

CHAPTER 150.

VIRGINIA GAS AND OIL REGULATION.

4 VAC 25-150-10. Definitions.

The following words and terms, when used in this chapter, shall have the following meaning unless the context clearly indicates otherwise:

"Act" means the Virginia Gas and Oil Act of 1990, Chapter 22.1 (§ 45.1-361.1 et seq.) of Title 45.1 of the Code of Virginia.

"Adequate channel" means a watercourse that will convey ~~a chosen~~ the designated frequency storm event without overtopping its banks or causing erosive damage to the bed, banks and overbank sections.

"Approved" means accepted as suitable for its intended purpose when included in a permit issued by the director or determined to be suitable in writing by the director.

"Berm" means a ridge of soil or other material constructed along an active earthen fill to divert runoff away from the

Final Regulations

unprotected slope of the fill to a stabilized outlet or sediment trapping facility.

"*Bridge*" means an obstruction intentionally placed in a well at any a specified depth.

"*Cased completion*" means a technique used to make a well capable of production in which production casing is set through the productive zones.

"*Cased/open hole completion*" means a technique used to make a well capable of production in which at least one zone is completed through casing and at least one zone is completed open hole.

"*Casing*" means all pipe set in wells except conductor pipe and tubing.

"*Causeway*" means a temporary structural span constructed across a flowing watercourse or wetland to allow construction traffic to access the area without causing erosion damage.

"*Cement*" means hydraulic cement properly mixed with water.

"*Channel*" means a natural stream or man-made waterway.

"*Chief*" means the Chief of the Division of Mines of the Department of Mines, Minerals and Energy.

"*Coal protection string*" means a casing designed to protect a coal seam by excluding all fluids, oil, gas or gas pressure from the seam, except such as may be found in the coal seam itself.

"*Cofferdam*" means a temporary structure in a river, lake or other waterway for keeping the water from an enclosed area that has been pumped dry so that bridge foundations, pipelines, etc., may be constructed.

"*Completion*" means the process which results in a well being capable of producing gas or oil.

"*Conductor pipe*" means the short, large diameter string used primarily to control caving and washing out of unconsolidated surface formations.

"*Corehole*" means any shaft or hole sunk, drilled, bored or dug, that breaks or disturbs the surface of the earth as part of a geophysical operation for the purpose of exploration for gas or oil. The term shall not include a borehole used solely for the placement of an explosive charge or other energy source for generating seismic waves.

"*Days*" means calendar days.

"*Denuded area*" means land that has been cleared of vegetative cover.

"*Department*" means the Department of Mines, Minerals and Energy.

"*Detention basin*" means a stormwater management facility which temporarily impounds and discharges runoff through an outlet to a downstream channel. Infiltration is

negligible when compared to the outlet structure discharge rates. The facility is normally dry during periods of no rainfall.

"*Dike*" means an earthen embankment constructed to confine or control fluids.

"*Directional survey*" means a well survey that measures the degree of deviation of a hole, or distance, from the vertical and the direction of deviation.

"*Director*" means the Director of the Department of Mines, Minerals and Energy or his authorized agent.

"*Diversion*" means a channel constructed for the purpose of intercepting surface runoff.

"*Diverter*" or "*diverter system*" means an assembly of valves and piping attached to a gas or oil well's casing for controlling flow and pressure from a well.

"*Division*" means the Division of Gas and Oil of the Department of Mines, Minerals and Energy.

"*Erosion and sediment control plan*" means a document containing a description of materials and methods to be used for the conservation of soil and the protection of water resources in or on a unit or group of units of land. It may include appropriate maps, an appropriate soil and water plan inventory and management information with needed interpretations, and a record of decisions contributing to conservation treatment. The plan shall contain a record of all major conservation decisions to ensure that the entire unit or units of land will be so treated to achieve the conservation objectives.

"*Expanding cement*" means any cement approved by the director which expands during the hardening process, including but not limited to regular oil field cements with the proper additives.

"*Form prescribed by the director*" means a form issued by the division, or an equivalent facsimile, for use in meeting the requirements of the Act or this chapter.

"*Firewall*" means an earthen dike or fire resistant structure built around a tank or tank battery to contain the oil in the event a tank ruptures or catches fire.

"*Flume*" means a constructed device lined with erosion-resistant materials intended to convey water on steep grades.

"*Flyrock*" means any material propelled by a blast that would be actually or potentially hazardous to persons or property.

"*Gas well*" means any well which produces or appears capable of producing a ratio of 6,000 cubic feet (6 Mcf) of gas or more to each barrel of oil, on the basis of a gas-oil ratio test.

"*Gob well*" means a coalbed methane gas well which is capable of producing coalbed methane gas from the de-stressed zone associated with any full-seam extraction of coal that extends above and below the mined-out coal seam.

"*Groundwater*" means all water under the ground, wholly or partially within or bordering the Commonwealth or within its jurisdiction, which has the potential for being used for domestic, industrial, commercial or agricultural use or otherwise affects the public welfare.

"*Highway*" means any public street, public alley, or public road.

"*Inclination survey*" means a well or corehole survey, using the surface location of the well or corehole as the apex, to determine the deviation of the well or corehole from the true vertical beneath the apex on the same horizontal subsurface plane.

"*Inhabited building*" means a building, regularly occupied in whole or in part by human beings, including, but not limited to, a private residence, church, school, store, public building or other structure where people are accustomed to assemble except for a building being used on a temporary basis, on a permitted site, for gas, oil, or geophysical operations.

"*Intermediate string*" means a string of casing that prevents caving, shuts off connate water in strata below the water protection string, and protects strata from exposure to lower zone pressures.

"*Live watercourse*" means a definite channel with bed and banks within which water flows continuously.

"*Mcf*" means, when used with reference to natural gas, 1,000 cubic feet of gas at a pressure base of 14.73 pounds per square inch gauge and a temperature base of 60°F.

"*Mud*" means any mixture of water and clay or other material as the term is commonly used in the industry.

"*Natural channel*" or "*natural stream*" means nontidal waterways that are part of the natural topography. They usually maintain a continuous or seasonal flow during the year, and are characterized as being irregular in cross section with a meandering course.

"*Nonerodible*" means a material such as riprap, concrete or plastic that will not experience surface wear due to natural forces.

"*Oil well*" means any well which produces or appears capable of producing a ratio of less than 6,000 cubic feet (6 Mcf) of gas to each barrel of oil, on the basis of a gas-oil ratio test.

"*Open hole completion*" means a technique used to make a well capable of production in which no production casing is set through the productive zones.

"*Person*" means any individual, corporation, partnership, association, company, business, trust, joint venture or other legal entity.

"*Plug*" means the stopping of, or a device used for the stopping of, the flow of water, gas or oil from one stratum to another.

"*Pre-development*" means the land use and site conditions that exist at the time that the operations plan is submitted to the division.

"*Produced waters*" means water or fluids produced from a gas well, oil well, coalbed methane gas well or gob well as a byproduct of producing gas, oil or coalbed methane gas.

"*Producer*" means a permittee operating a well in Virginia that is producing or is capable of producing gas or oil.

"*Production string*" means a string of casing or tubing through which the well is completed and may be produced and controlled.

"*Red shales*" means the undifferentiated shaley portion of the bluestone formation normally found above the Pride Shale Member of the formation, and extending upward to the base of the Pennsylvanian strata, which red shales are predominantly red and green in color but may occasionally be gray, grayish green and grayish red.

"*Retention basin*" means a stormwater management facility which, similar to a detention basin, temporarily impounds runoff and discharges its outflow through an outlet to a downstream channel. A retention basin is a permanent impoundment.

"*Sediment basin*" means a depression formed from the construction of a barrier or dam built to retain sediment and debris.

"*Sheet flow*," also called overland flow, means shallow, unconcentrated and irregular flow down a slope. The length of strip for sheet flow usually does not exceed 200 feet under natural conditions.

"*Slope drain*" means tubing or conduit made of nonerosive material extending from the top to the bottom of a cut or fill slope.

"*Special diligence*" means the activity and skill exercised by a good businessman in his particular specialty, which must be commensurate with the duty to be performed and the individual circumstances of the case; not merely the diligence of an ordinary person or nonspecialist.

"*Stabilized*" means able to withstand normal exposure to air and water flows without incurring erosion damage.

"*Stemming*" means the inert material placed in a borehole after an explosive charge for the purpose of confining the explosion gases in the borehole or the inert material used to separate the explosive charges (decks) in decked holes.

"*Storm sewer inlet*" means any structure through which stormwater is introduced into an underground conveyance system.

"*Stormwater management facility*" means a device that controls stormwater runoff and changes the characteristics of that runoff, including but not limited to, the quantity, quality, the period of release or the velocity of flow.

"*String of pipe*" or "*string*" means the total footage of pipe of uniform size set in a well. The term embraces conductor

Final Regulations

pipe, casing and tubing. When the casing consists of segments of different size, each segment constitutes a separate string. A string may serve more than one purpose.

"Sulfide stress cracking" means embrittlement of the steel grain structure to reduce ductility and cause extreme brittleness or cracking by hydrogen sulfide.

"Surface mine" means an area containing an open pit excavation, surface operations incident to an underground mine, or associated activities adjacent to the excavation or surface operations, from which coal or other minerals are produced for sale, exchange, or commercial use; and includes all buildings and equipment above the surface of the ground used in connection with such mining.

"Target formation" means the geologic gas or oil formation identified by the well operator in his application for a gas, oil or geophysical drilling permit.

"Temporary stream crossing" means a temporary structural span installed across a flowing watercourse for use by construction traffic. Structures may include bridges, round pipes or pipe arches constructed on or through nonerodible material.

"Ten-year frequency storm" means a storm that is capable of producing rainfall expected to be equaled or exceeded on the average of once in 10 years. It may also be expressed as an exceedance probability with a 10% chance of being equaled or exceeded in any given year.

"Tubing" means the small diameter string set after the well has been drilled from the surface to the total depth and through which the gas or oil or other substance is produced or injected.

"Two-year frequency storm" means a storm that is capable of producing rainfall expected to be equaled or exceeded on the average of once in two years. It may also be expressed as an exceedance probability with a 50% chance of being equaled or exceeded in any given year.

"Vertical ventilation hole" means any hole drilled from the surface to the coal seam used only for the safety purpose of removing gas from the underlying coal seam and the adjacent strata, thus, removing the gas that would normally be in the mine ventilation system.

"Water bar" means a small obstruction constructed across the surface of a road to interrupt the flow of water down the grade of the road and divert the water to provide for sediment control.

"Water protection string" means a string of casing designed to protect groundwater bearing strata.

4 VAC 25-150-50. Gas or oil in holes not permitted as a gas or oil well.

~~A. Gas or oil shall not be captured and used for any purpose from any well, shaft or hole, other than a permitted gas or oil well.~~

~~B. If gas or oil is captured and used from any well in place on September 25, 1991, and not permitted by the~~

~~department as a gas or oil well and the gas or oil is used near the well and not transported to a pipeline regulated by the Federal Energy Regulatory Commission or the State Corporation Commission or the oil is not otherwise marketed, the owner or operator of such well shall meet the following standards.~~

~~1. The owner or operator may apply for a permit for a well in accordance with § 45.1-361.29 of the Code of Virginia. The owner or operator may apply to the director for a variance to the casing standards of this chapter. The request must document that the proposed variance provides comparable protection. The variance request shall address, but not be limited to, the following:~~

- ~~a. The method of wellbore completion, whether cased, open or cased/open hole;~~
- ~~b. Coal seams to be left uncased;~~
- ~~c. Mining activity currently being conducted within 750 feet of the location;~~
- ~~d. Depth of the water protection string; and~~
- ~~e. The pressure tests to document the integrity of the casing program; or~~

~~2. In the case of gas, the owner or operator may, with the director's approval, vent the well in such a manner as to allow for the passage of the gas out to the atmosphere without a build up of pressure, but not allow passage of water, insects, or foreign materials into the well. In cases where other regulatory standards that govern the techniques for venting a well are in conflict with this subdivision, those other regulatory standards shall govern venting of the well, shaft or hole.~~

~~C. In the event the owner or operator of a well any person captures and uses gas or oil and does not permit or vent the shaft or hole as a gas or oil well as provided for in subsection B of this section chapter, the director shall take the necessary appropriate enforcement actions to ensure the well does not pose safety or environmental hazards, and may require that the well be plugged action.~~

~~D. The department shall notify coal interests of all wells in which the owner or operator is venting the gas rather than permitting or plugging the well as provided for in subsection B of this section.~~

4 VAC 25-150-60. Due dates for reports and decisions.

A. Where the last day fixed for (i) submitting a request for a hearing, holding a hearing or issuing a decision in an enforcement action under Article 3 (4 VAC 25-150-170 et seq.) of this chapter part, (ii) submitting a monthly or annual report under Article 4 (4 VAC 25-150-210 et seq.) of this chapter part, (iii) submitting a report of commencement of activity under 4 VAC 25-150-230 of this chapter, (iv) submitting a drilling report, a completion report or other report under 4 VAC 25-150-360 of this chapter, or (v) submitting a plugging affidavit under 4 VAC 25-150-460 of this chapter falls on a Saturday, Sunday, or any day on

which the Division of Gas and Oil office is closed as authorized by the Code of Virginia or the Governor, the required action may be done on the next day that the office is open.

B. All submittals to or notifications of the Division of Gas and Oil identified in subsection A of this section shall be made to the division office no later than 5 p.m. on the day required by the Act or by this chapter.

4 VAC 25-150-70. Documents incorporated by reference. (Repealed.)

~~No documents are incorporated by reference.~~

4 VAC 25-150-80. Application for a permit.

A. Applicability.

1. Persons required in § 45.1-361.29 of the Code of Virginia to obtain a permit or permit modification shall apply to the division on the forms prescribed by the director. All lands on which gas, oil or geophysical operations are to be conducted, ~~including all areas proposed to be used for land application of fluids~~ shall be included in a permit application.

2. In addition to specific requirements for variances in other sections of this chapter, any applicant for a variance shall, in writing, document the need for the variance and describe the alternate measures or practices to be used.

B. The application for a permit shall, as applicable, be accompanied by the fee in accordance with § 45.1-361.29 of the Code of Virginia, the bond in accordance with § 45.1-361.31 of the Code of Virginia, and the fee for the Orphaned Well Fund in accordance with § 45.1-361.40 of the Code of Virginia.

C. Each application for a permit shall include information on all activities, including those involving associated facilities, to be conducted on the permitted site. This shall include, ~~but is not limited to the following:~~

1. The name and address of:
 - a. The gas, oil or geophysical applicant;
 - b. The agent required to be designated under § 45.1-361.37 of the Code of Virginia; and
 - c. Each person whom the applicant must notify under § 45.1-361.30 of the Code of Virginia;
2. The certifications required in § 45.1-361.29 E of the Code of Virginia;
3. The proof of notice required in § 45.1-361.29 E of the Code of Virginia, which shall be:
 - a. A copy of a signed receipt of delivery of notice by certified mail;
 - b. A copy of a signed receipt acknowledging delivery of notice by hand; or

c. If all copies of receipt of delivery of notice by certified mail have not been signed and returned within 15 days of mailing, a copy of the mailing log or other proof of the date the notice was sent by certified mail, return receipt requested;

4. Identification of the type of well or other gas, oil or geophysical operation being proposed;

5. The plat in accordance with 4 VAC 25-150-90 ~~of this chapter;~~

6. The operations plan in accordance with 4 VAC 25-150-100 ~~of this chapter;~~

7. The information required for operations involving hydrogen sulfide in accordance with 4 VAC 25-150-350 ~~of this chapter;~~

8. ~~The location where the~~ Spill Prevention Control and Countermeasure (SPCC) plan *is available*, if one ~~has been developed for the site~~ *is required*;

9. The Department of Mines, Minerals and Energy, Division of Mined Land Reclamation's permit number for any area included in a Division of Mined Land Reclamation permit on which a proposed gas, oil or geophysical operation is to be located;

10. For an application for a conventional well, the information required in 4 VAC 25-150-500 ~~of this chapter;~~

11. For an application for a coalbed methane gas well, the information required in 4 VAC 25-150-560 ~~or 4 VAC 25-150-570 of this chapter;~~

12. For an application for a geophysical operation, the information required in 4 VAC 25-150-670 ~~of this chapter; and~~

13. For an application for a permit to drill for gas or oil in Tidewater Virginia, the environmental impact assessment meeting the requirements of § 62.1-195.1 ~~C B~~ of the Code of Virginia; ~~and.~~

~~14. Any other information required by the director.~~

4 VAC 25-150-90. Plats.

A. When filing an application for a permit for a well or corehole, the applicant also shall file an accurate plat certified by a licensed professional engineer or licensed land surveyor on a scale, to be stated thereon, of 1 inch equals 400 feet (1:4800). The scope of the plat shall be large enough to show all areas within the greater of 750 feet or one half of the distance specified in § 45.1-361.17 of the Code of Virginia from the proposed well or corehole, or within a unit established by the board for the subject well. The plat shall be submitted on a form prescribed by the director.

B. The known courses and distances of all property lines and lines connecting the permanent points, landmarks or corners within the scope of the plat shall be shown thereon. All lines actually surveyed shall be shown as solid lines.

Final Regulations

Lines taken from deed descriptions only shall be shown by broken lines.

C. A north and south line shall be given and shown on the plat, and point to the top of the plat.

D. Wells or coreholes shall be located on the plat as follows:

1. The proposed or actual surface elevation of the subject well or corehole shall be shown on the plat, within an accuracy of one vertical foot. The surface elevation shall be tied to either a government benchmark or other point of proven elevation by differential or aerial survey or by trigonometric leveling. The location of the government benchmark or the point of proven elevation and the method used to determine the surface elevation of the subject well or corehole shall be noted and described on the plat.

2. The proposed or actual horizontal location of the subject well or corehole determined by survey shall be shown on the plat. ~~Effective October 1, 1992, The proposed or actual well or corehole location shall be shown in accordance with the Virginia Coordinate System of 1927, as defined in Chapter 17 (§ 55-287 et seq.) of Title 55 of the Code of Virginia, also known as the State Plane Coordinate System. Until October 1, 1992, if the subject well or corehole is not located in accordance with the State Plane Coordinate System, the measured distance in feet from the well or corehole to the nearest 2.5 minute longitude line to the east, and the nearest 2.5 minute latitude line to the north on the 7.5 minute (1:24,000) topographic map shall be shown; with a notation of the 7.5 minute topographic map name and series. Applicants are encouraged to use the State Plane Coordinate System prior to October 1, 1992.~~

3. The courses and distances of the well or corehole location from two permanent points or landmarks on the tract shall be shown; such landmarks shall be set stones, iron pipes, T-rails or other manufactured monuments, including mine coordinate monuments, and operating or abandoned wells which are platted to the accuracy standards of this section and on file with the division. If temporary points are to be used to locate the actual well or corehole location as provided for in 4 VAC 25-150-290 of this chapter, the courses and distances of the well or corehole location from the two temporary points shall be shown.

4. Any other well, permitted or drilled, within the distance specified in § 45.1-361.17 of the Code of Virginia or the distance to the nearest well completed in the same pool, whichever is less, or within the boundaries of a drilling unit established by the board around the subject well shall be shown on the plat or located by notation. ~~The depth to which each well has been or is proposed to be drilled shall be shown.~~ The type of each well shall be designated by the following symbols:

- a. New drilling location ○
- ~~b. New stimulating location~~ ○ F/S
- e. b. Canceled application or permit ○ CNC
- d. c. Oil well ●
- ~~e. d.~~ Gas well [other than CBM] ☼
- f. e. Dry hole ☐ [⊖] &
- ~~g. f.~~ Enhanced oil recovery injection well ⊕ LI
- h. g. Waste disposal well ⊕ WD
- ~~i. h.~~ Underground gas storage well ⊖ ☼ GS
- ~~j. i.~~ Abandoned well 9 ☼ LI ☼ WD
- ~~k. j.~~ New coalbed methane drilling location ○ CBM
- ~~l. k.~~ Coalbed methane gas well ☼ CBM
- ~~m. l.~~ Abandoned coalbed methane gas well ☼

E. Plats shall also contain:

1. For a conventional gas and oil or injection well, the information required in 4 VAC 25-150-510 ~~of this chapter;~~
2. For a coalbed methane gas well, the information required in 4 VAC 25-150-590 of this chapter; or
3. For a corehole, the information required in 4 VAC 25-150-680 of this chapter.

F. Any subsequent application for a new permit or permit modification shall include an accurate copy of the well plat, updated as necessary to reflect any changes on the site, newly discovered data or additional data required since the last plat was submitted. Any revised plat shall be certified as required in subsection A of this section.

4 VAC 25-150-100. Operations plans.

A. Each application for a permit or permit modification shall include an operations plan, in a format approved by or on a form prescribed by the director. The operations plan and accompanying maps or drawings shall become part of the terms and conditions of any permit which is issued.

~~B. The operations plan shall sufficiently describe operations to be conducted, including how risks to the public safety or to the site and adjacent lands are to be managed. The plan shall include, but not be limited to: The applicant shall indicate how risks to the public safety or to the site and adjacent lands are to be managed, consistent with the requirements of § 45.1-361.27 B of the Code of Virginia, and shall provide a short narrative, if pertinent.~~

1. A description of the pre-development condition of the site, which shall include, but not be limited to:
 - a. ~~A description of the slope, vegetative cover, surface waters, wetlands, groundwater, public water supply intakes, existing land use, man-made~~

improvements, and if the site is in a 100-year floodplain;

~~b. A description of any feature on adjacent lands, including but not limited to the types of features identified in subdivision B 1 a of this section, that would be at risk should there be an accident on the permitted site; and~~

~~c. A description of the subsurface geology if drilling is proposed;~~

~~2. A description of construction to be undertaken on the site, including a statement of the acres to be disturbed, to the nearest 1/10 of an acre, information on blasting in accordance with 4 VAC 25-150-250 of this chapter and a map showing the location of all proposed new roads and existing access roads;~~

~~3. An erosion and sediment control plan and description of reclamation to be completed on the site in accordance with 4 VAC 25-150-260 of this chapter;~~

~~4. A description of all equipment and facilities, including tank batteries and wellhead equipment, to be used on site during and after drilling and completion of the well or corehole, or construction of a gathering pipeline or associated facilities; including a schematic drawing or drawings showing the placement of such equipment and facilities;~~

~~5. A description of the design and operation of any pits, in accordance with 4 VAC 25-150-300 of this chapter;~~

~~6. A description of the drilling and stimulating program, including information on the water and constituents of the drilling fluids to be used in the various stages of drilling and stimulating in accordance with 4 VAC 25-150-340 of this chapter;~~

~~7. A description of how pit fluids, produced waters, drill cuttings and solids are to be managed and disposed of in accordance with 4 VAC 25-150-420 and 4 VAC 25-150-430 of this chapter; including maps depicting the scope of any proposed on-site land application of pit fluids, and a description of how other fluids and wastes from gas and oil operations are to be managed;~~

~~8. For geophysical operations, the information required in 4 VAC 25-150-690 of this chapter; and~~

~~9. For gathering pipelines, the information required in 4 VAC 25-150-740 of this chapter.~~

~~C. Maps, drawings and plans shall be certified by a licensed professional engineer or licensed land surveyor.~~

4 VAC 25-150-110. Permit amendments supplements and permit modifications.

A. Permit amendments supplements.

1. Applicability. If circumstances arise which require a change to any activity which has previously been approved on the permitted site, then the permittee shall request an amendment to the permit. *Standard permit*

supplements. A permittee shall be allowed to submit a permit supplement when work being performed either:

a. Does not change the disturbance area as described in the original permit; or

b. Involves activities previously permitted.

The permittee shall submit written documentation of the changes made to the permitted area within seven working days [before after] completing the change. All other changes to the permit shall require a permit modification in accordance with § 45.1-361.29 of the Code of Virginia.

~~2. Notice and fees. Notice and fees are not required for a permit amendment.~~

~~3. Standard permit amendments. For any circumstance other than when an emergency amendment is allowed, the permittee shall submit a written request to amend the permit. The permittee may not undertake the proposed work until he has received written approval from the director. The request shall include, but not be limited to:~~

~~a. A description of the activity to be changed;~~

~~b. A description of the proposed new activity; and~~

~~c. Any data, maps, plats or other information required by the director.~~

4. 2. Emergency permit amendments supplements. If the proposed amendment a change must be implemented immediately due to actual or threatened imminent danger to the public safety or to the environment, the permittee shall:

a. Take immediate action to minimize the danger to the public or to the environment;

a. b. Orally request permission of and, if notify the director as soon as possible of actions taken to minimize the danger and, if the director determines an emergency still exists and grants oral approval, commence the change additional changes if necessary; and

b. c. Submit a written amendment supplement to the permit, within two seven working days of requesting notifying the amendment, containing director. The supplement shall contain a description of the activity which was changed, a description of the new activity, and any amended data, maps, plats, or other information required by the director.

~~The director shall forward written approval of the emergency permit amendment to the permittee, and include a copy of the approval with the division's records of the permit.~~

B. Permit modifications.

1. Applicability. A permittee shall obtain a permit modification whenever required in *All changes to the*

Final Regulations

permit which do not fit the description contained in subsection A of this section shall require a permit modification in accordance with § 45.1-361.29 of the Code of Virginia.

2. Notice and fees. Notice of a permit modification shall be given in accordance with § 45.1-361.30 of the Code of Virginia. The application for a permit modification shall be accompanied, as applicable, by the fee in accordance with § 45.1-361.29 of the Code of Virginia and the bond in accordance with § 45.1-361.31 of the Code of Virginia.

3. *Waiver of right to object.* Upon receipt of notice, any person may, on a form approved by the director, waive the time requirements and their right to object to a proposed permit modification. The department shall be entitled to rely upon the waiver to approve the permit modification.

~~3.~~ 4. Permit modification. The permittee shall submit a written application for a permit modification on a form prescribed by the director. The permittee may not undertake the proposed work until ~~he has received written approval from the director~~ the permit modification has been issued. The application shall include, but not be limited to:

- a. The name and address of:
 - (1) The permittee; and
 - (2) Each person whom the applicant must notify under § 45.1-361.30 of the Code of Virginia;
- b. The certifications required in § 45.1-361.29 E of the Code of Virginia;
- c. The proof of notice required in § 45.1-361.29 E of the Code of Virginia, as provided for in ~~4 VAC 25-150-180 C 3 of this chapter~~ 4 VAC 25-150-80 C 3;
- d. Identification of the type of work for which a permit modification is requested;
- e. The plat in accordance with ~~§ 1.9 of this chapter~~ 4 VAC 25-150-90;
- f. All data, maps, plats and plans in accordance with 4 VAC 25-150-100 ~~of this chapter~~ necessary to describe the activity proposed to be undertaken;
- g. When the permit modification includes abandoning a gas or oil well as a water well, a description of the plugging to be completed up to the water bearing formation and a copy of the permit issued for the water well by the Virginia Department of Health;
- h. The information required for operations involving hydrogen sulfide in accordance with 4 VAC 25-150-350 ~~of this chapter~~ if applicable to the proposed operations;
- i. The location where the Spill Prevention Control and Countermeasure (SPCC) plan is available, if one has

been developed for the site of the proposed operations;

j. The Department of Mines, Minerals and Energy, Division of Mined Land Reclamation's permit number for any area included in a Division of Mined Land Reclamation permit; and

k. The information, as appropriate, required in ~~4 VAC 25-150-490~~ 4 VAC 25-150-500, 4 VAC 25-150-560, ~~4 VAC 25-150-570~~, or 4 VAC 25-150-670 ~~of this chapter~~; and

~~l. Any other information required by the director.~~

4 VAC 25-150-120. Transfer of permit rights.

A. Applicability.

1. No transfer of rights granted by a permit shall be made without prior approval from the director.
2. Any approval granted by the director of a transfer of permit rights shall, ~~after September 25, 1991~~, be conditioned upon the proposed new operator complying with all requirements of the Act, this chapter and the permit.

B. Application. Any person requesting a transfer of rights granted by a permit shall submit a written application on a form prescribed by the director. The application shall be accompanied by a fee of \$50 and bond, in the name of the person requesting the transfer, in accordance with § 45.1-361.31 of the Code of Virginia. The application shall contain, but is not limited to:

1. The name and address of the current permittee, the current permit number and the name of the current operation;
2. The name and address of the proposed new operator and the proposed new operations name;
3. Documentation of approval of the transfer by the current permittee;
4. ~~Certification that the proposed new operator has the right to conduct the operations and will comply with all of the requirements of the Act and this chapter, and conditions of the permit;~~

~~5.~~ 4. If the permit was issued on or before September 25, 1991, an updated operations plan, in accordance with 4 VAC 25-150-100 ~~of this chapter~~, showing how all permitted activities to be conducted by the proposed new permittee will comply with the standards of this chapter;

~~6.~~ 5. If the permit was issued on or before September 25, 1991, for a well, a plat meeting the requirements of 4 VAC 25-150-90 ~~of this chapter~~ updated to reflect any changes on the site, newly discovered data or additional data required since the last plat was submitted, including the change in ownership of the well; and

~~7.~~ 6. If the permit was issued on or before September 25, 1991, if applicable, the docket number and date of

recordation of any order issued by the board for a pooled unit, pertaining to the current permit.

~~C. Notification.~~

~~The proposed new operator shall, within one day of the day on which the application is filed, publish a notice of the application for transfer of the permit rights in a newspaper of general circulation in the locality where the operation subject to the application is located. The notice shall contain, at a minimum, the name and address of the proposed new operator, the name and address of the current permittee, the current permit number, the current operations name, and the name of the city or county where the operation subject to the application is located.~~

~~D. C. Standards for approval.~~

The director shall not approve the transfer of permit rights unless the proposed new permittee:

1. Has registered with the department in accordance with § 45.1-361.37 of the Code of Virginia;
2. Has posted acceptable bond in accordance with § 45.1-361.31 of the Code of Virginia; *and*
- ~~3. Has no outstanding violations of or outstanding penalties under the Act, this chapter or conditions of a permit on any other permitted gas or oil operation in the Commonwealth; and~~
4. 3. Has no outstanding debt pursuant to § 45.1-361.32 of the Code of Virginia.

~~E. The current permittee shall be responsible for any violations of or penalties under the Act, this chapter, or conditions of the permit prior to the director's approval of the transfer of permit rights. No transfer of permit rights may occur if there are unabated violations under the permit to be transferred.~~

~~F. D. The new permittee shall be responsible for any violations of or penalties under the Act, this chapter, or conditions of the permit after the director has approved the transfer of permit rights.~~

4 VAC 25-150-130. Notice of permit applications and modifications.

A. Gas, oil or geophysical operators shall provide notice of an application for a permit or permit modification in accordance with § 45.1-361.30 of the Code of Virginia, as identified on the "Technical Data Sheet for Permit Applications Under § 45.1-361.29," prescribed by the director.

B. If notice required under § 45.1-361.30 of the Code of Virginia has been sent by certified mail, return receipt requested, and the notice has not been delivered within 15 days of mailing the notice, the director shall consider notice to be given *as of the end of the 15-day period and the objection period specified in § 45.1-361.35 shall commence.*

4 VAC 25-150-135. Waiver of right to object to permit applications.

Upon receipt of notice, any person may, on a form approved by the director, waive the time requirements and their right to object to a proposed permit application. The department shall be entitled to rely upon the waiver to approve the permit application.

4 VAC 25-150-160. Approval of permits, permit amendments and permit modifications.

A. Permits, ~~permit amendments~~, permit modifications and transfer of permit rights shall be granted in writing by the director.

B. The director may not issue a permit or permit modification prior to the end of the time period for filing objections pursuant to § 45.1-361.35 of the Code of Virginia-*unless, upon receipt of notice, any person may, on a form approved by the director, waive the time requirements and their right to object to a proposed permit application or permit modification application. The department shall be entitled to rely upon the waiver to approve the permit application or permit modification.*

C. The director may not issue a permit to drill for gas or oil in Tidewater Virginia until he has considered the findings and recommendations of the Department of Environmental Quality, as provided for in § 62.1-195.1 of the Code of Virginia; and, where appropriate, has required changes in the permitted activity based on the ~~council's~~ *Department of Environmental Quality's* recommendations.

D. The provisions of any order of the Virginia Gas and Oil Board that govern a gas or oil well permitted by the director shall become conditions of the permit.

4 VAC 25-150-170. Enforcement.

A. The director shall enforce the provisions of the Act, this chapter, *4 VAC 25 Chapter 160 (4 VAC 25-160-10 et seq.) entitled "The Virginia Gas and Oil Board Regulation," any board order, or any condition of a permit, and may use the following methods:*

1. *Obtaining voluntary compliance through conference, warning or other means prior to issuing any enforcement notice or order;*
- ~~4.~~ 2. *Issuing notices of violation in accordance with 4 VAC 25-150-180 of this chapter;*
- ~~2.~~ 3. *Issuing closure orders in accordance with 4 VAC 25-150-190 of this chapter;*
- ~~3.~~ 4. *Issuing show cause orders in accordance with 4 VAC 25-150-200 of this chapter;*
4. 5. *Issuing emergency orders in accordance with § 45.1-361.27 D of the Code of Virginia; or*
- ~~5.~~ 6. *Any other action in accordance with the Code of Virginia.*

Final Regulations

~~B. Nothing in this chapter shall prevent the director from taking any action or from making efforts to obtain voluntary compliance through conference, warning or other means prior to issuing any enforcement notice or order.~~

~~G. B.~~ The purpose of taking enforcement actions under this section is to obtain compliance with the provisions of the Act, this chapter, 4 VAC 25 Chapter 160 (4 VAC 25-160-10 et seq.) entitled "The Virginia Gas and Oil Board Regulation," any board order, or conditions of a permit.

~~D. C.~~ Reclamation operations and other activities intended to protect the public health and safety and the environment shall continue during the period of any notice or order unless otherwise provided in the notice or order.

~~E. D.~~ Any person found to be conducting a gas, oil or geophysical operation without a permit from the director shall be subject to enforcement for operating without a permit and for not meeting any other standards of the Act or this chapter which would be required if the person was operating under a permit.

~~F. E.~~ Decisions of the director may be appealed to the Virginia Gas and Oil Board pursuant to § 45.1-361.23 of the Code of Virginia.

4 VAC 25-150-180. Notices of violation.

A. The director may issue a notice of violation if he finds a violation of any of the following:

1. Chapter 22.1 (§ 45.1-361.1 et seq.) of Title 45.1 of the Code of Virginia;
2. This chapter;
3. 4 VAC 25 Chapter 160 (4 VAC 25-160-10 et seq.) entitled "The Virginia Gas and Oil Board Regulation";
4. Any board order; or
5. Any condition of a permit, which does not create an imminent danger or harm for which a closure order must be issued under 4 VAC 5-150-190 of this chapter.

B. A notice of violation shall be in writing, signed, and set forth with reasonable specificity:

1. The nature of the violation, including a reference to the section or sections of the Act, applicable regulation, order or permit condition which has been violated;
2. A reasonable description of the portion of the operation to which the violation applies, including an explanation of the condition or circumstance that caused the portion of the operation to be in violation, if it is not self-evident in the type of violation itself;
3. The remedial action required, which may include interim steps; and
4. A reasonable deadline for abatement, which may include a deadline for accomplishment of interim steps.

C. The director may extend the deadline for abatement or for accomplishment of an interim step, if the failure to meet

the deadline previously set was not caused by the permittee's lack of diligence. The total time for abatement under a notice of violation, including all extensions, shall not exceed 20 days from the date of issuance, except upon a showing by the permittee and approval by the director that it is not feasible to abate the violation within 20 days, or if the deadline is extended by the director during an appeal. An extension of the deadline for abatement may not be granted when the permittee's failure to abate within 20 days has been caused by a lack of diligence or intentional delay by the permittee in completing the remedial action required.

D. If the permittee fails to meet the deadline for abatement or for completion of any interim steps, the director shall issue a closure order under 4 VAC 25-150-190 of this chapter.

E. The director shall terminate a notice of violation by written notice to the permittee when he determines that all violations listed in the notice of violation have been abated.

F. A permittee issued a notice of violation may request, in writing to the director, an informal fact-finding hearing to review the issuance of the notice, in writing to the director, within the deadline established for abatement of the violation. This written request should be made within 10 days of receipt of the notice. The permittee may request, in writing to the director, an expedited hearing.

G. A permittee is not relieved of the duty to abate any violation under a notice of violation during an appeal of the notice. A permittee may apply for an extension of the deadline for abatement during an appeal of the notice.

H. The director shall issue a decision on any request for an extension of the deadline for abatement under a notice of violation within five days of receipt of such request. The director shall conduct an informal fact-finding hearing, in accordance with the Administrative Process Act, § 9-6.14:11 of the Code of Virginia, no later than 10 days after receipt of the hearing request.

I. The director shall affirm, modify, or vacate the notice in writing to the permittee within five days after of the date of the hearing.

4 VAC 25-150-190. Closure orders.

A. The director shall immediately order a cessation of operations or of the relevant portion thereof, when he finds any condition or practice which:

1. Creates or can be reasonably expected to create an imminent danger to the health or safety of the public, including miners; or
2. Causes or can reasonably be expected to cause significant, imminent, environmental harm to land, air or water resources.

B. The director may order a cessation of operations or of the relevant portion thereof, when:

1. A permittee fails to meet the deadline for abatement or for completion of any interim step under a notice of violation;
2. Repeated notices of violations have been issued for the same condition or practice; or
3. Gas, oil or geophysical operations are being conducted by any person without a valid permit from the Division of Gas and Oil.

C. A closure order shall be in writing, signed and shall set forth with reasonable specificity:

1. The nature of the condition, practice or violation;
2. A reasonable description of the portion of the operation to which the closure order applies;
3. The remedial action required, if any, which may include interim steps; and
4. A reasonable deadline for abatement, which may include deadline for accomplishment of interim steps.

D. A closure order shall require the person subject to the order to take all steps the director deems necessary to abate the violations covered by the order in the most expeditious manner physically possible.

E. If a permittee fails to abate a condition or practice or complete any interim step as required in a closure order, the director shall issue a show cause order under 4 VAC 25-150-200 of this chapter.

F. The director shall terminate a closure order by written notice to the person subject to the order when he determines that all conditions, practices or violations listed in the order have been abated.

G. A person issued a closure order may request, *in writing to the director*, an informal fact-finding hearing to review the issuance of the order, ~~in writing to the director~~, within 10 days ~~from~~ of receipt of the order. The person may request, *in writing to the director*, an expedited hearing, ~~in writing to the director~~, within three days of receipt of the order.

H. A person is not relieved of the duty to abate any condition under, or comply with, any requirement of a closure order during an appeal of the order.

I. The director shall conduct an informal fact-finding hearing, in accordance with the Administrative Process Act, § 9-6.14:11 of the Code of Virginia, no later than 15 days after the order was issued, or in the case of an expedited hearing, no later than five days after the order was issued.

J. The director shall affirm, modify, or vacate the closure order in writing to the person the order was issued to no later than five days after the date of the hearing.

4 VAC 25-150-200. Show cause orders.

A. The director may issue a show cause order to a permittee requiring justification for why his permit should not be suspended or revoked whenever:

1. A permittee fails to abate a condition or practice or complete any interim step as required in a closure order; ~~or~~

2. A permittee fails to ~~diligently pursue activity in accordance with 4 VAC 25-150-230 of this chapter. comply with the provisions of 4 VAC 25 Chapter 160 (4 VAC 25-160-10 et seq.) entitled "The Virginia Gas and Oil Board Regulation"; or~~

3. A permittee fails to comply with the provisions of an order issued by the Virginia Gas and Oil Board.

B. A show cause order shall be in writing, signed, and set forth with reasonable specificity:

1. The permit number of the operation subject to suspension or revocation; and
2. The reason for the show cause order.

C. The permittee shall have five days from receipt of the show cause order to request *in writing* an informal fact-finding hearing ~~in writing~~.

D. The director shall conduct an informal fact-finding hearing, in accordance with the Administrative Process Act, § 9-6.14:11 of the Code of Virginia, no later than five days after receipt of the request for the hearing.

E. The director shall issue a written decision within five days ~~after~~ of the date of the hearing.

F. If the permit is revoked ~~or suspended~~, the permittee shall immediately cease operations on the permit area and ~~shall complete reclamation within the deadline specified in the order.~~

~~1. If the permit is revoked, complete reclamation within the deadline specified in the order; or~~

~~2. If the permit is suspended, complete all actions to abate all conditions, practices or violations, as specified in the order.~~

G. *If the permit is suspended, the permittee shall immediately commence cessation of operations on the permit area and complete all actions to abate all conditions, practices or violations, as specified in the order.*

4 VAC 25-150-210. Monthly reports.

A. Each producer shall submit a monthly report, on a form prescribed by the director or in a format approved by the director, to the division no later than 45 days after the last day of each month.

B. Reports of gas production.

1. Every producer of gas shall report *in Mcf* the amount of production ~~in Mcf~~, from each well ~~and a summary of the volumes of in-field use, reserved or used by lessors and deliveries to pipelines.~~

2. Reports shall be summarized by county or city.

Final Regulations

3. Reports shall provide the date of any new connection of a well to a gathering pipeline or other marketing system.

C. Reports of oil production.

1. Every producer of oil shall report *in barrels* the amount of oil production, oil on hand and oil delivered, ~~in barrels~~, from each well.

2. Reports shall be summarized county or city.

3. Reports shall provide the date of any new connection of a well to a gathering pipeline or other marketing system.

D. *Reports of shut-in wells. If a well is shut-in or otherwise not produced during any month, it shall be so noted on the monthly report.*

4 VAC 25-150-220. Annual reports.

A. Each permittee shall submit a calendar-year annual report to the ~~the~~ division by no later than March 31 of the next year.

B. The annual report shall include as appropriate:

1. A confirmation of the accuracy of the *permittee's* current registration filed with the division ~~for the permittee~~, or a report of any change in the information;

2. The name, address and phone number or numbers of the ~~person~~ *persons* to be contacted at any time in case of an emergency;

3. Production of gas or oil on a well-by-well and county-by-county or city-by-city basis for each permit or as prescribed by the director and the average price received for each MCF of gas and barrel of oil;

4. Certification by the permittee that the permittee has paid all severance taxes for each permit; and

5. When required, payment to the Gas and Oil Plugging and Restoration Fund as required in § 45.1-361.32 of the Code of Virginia.

4 VAC 25-150-230. Commencement of activity.

A. Gas, oil or geophysical activity commences with ground disturbing activity.

B. A permittee shall notify the division at least two working days prior to commencing ground disturbing activity, drilling a well or corehole, completing *or recompleting* a well or plugging a well or corehole, ~~giving~~. *The permittee shall notify the division, either orally or in writing, of the permit number and the date and time that the work is scheduled to commence. Notice may be given orally or in writing.*

~~C. After commencement of permitted activity, a permittee shall diligently pursue the permitted activity.~~

~~D. Permittees shall meet the requirements for commencement of activity as required in § 45.1-361.33 of the Code of Virginia. If a permittee fails to diligently pursue permitted activity which was commenced within 24 months~~

~~from the date the permit was issued, the director may issue a show cause order to revoke the permit. This subsection applies to permits issued on or after September 25, 1991.~~

C. For dry holes and in emergency situations, the operator may notify the division within two working days of commencing plugging activities.

4 VAC 25-150-240. Signs.

A. Temporary signs. Each permittee shall keep a sign posted at the point where the access road enters the permitted area of each well or corehole being drilled or tested, showing the name of the well or corehole permittee, the well name and the permit number, the ~~telephone number~~ *for the Division of Gas and Oil phone number* and a ~~phone~~ *telephone number to contact use in case of an emergency or for reporting problems.*

The sign shall be posted from the commencement of construction until:

- 1. The well is completed;*
- 2. The dry hole or corehole is plugged;*
- 3. The site is stabilized; or*
- 4. The permanent sign is posted.*

B. Permanent signs. ~~4.~~ Each permittee shall keep a permanent sign posted in a conspicuous place on or near every producing well or well capable of being placed into production and on every associated facility. For any well drilled *or sign replaced* after September 25, 1991, the sign shall:

- ~~a.~~ 1. Be a minimum of 18 inches by 14 inches in size;
- ~~b.~~ 2. Contain, at a minimum, the permittee's name, the well name and the permit number, the Division of Gas and Oil phone number and ~~a phone~~ *the telephone number to contact use in case of an emergency or for reporting problems;*
- ~~c.~~ 3. Contain lettering a minimum of 1¼ inches high ~~in a color contrasting with the background~~; and
- ~~d.~~ 4. For a well, be located on the well or on a structure such as a meter house or pole located within ~~45~~ 50 feet of the well head.

~~2. Each permittee operating a gathering pipeline shall keep a permanent sign posted where a gathering pipeline is placed within a highway right-of-way. The sign shall meet the requirements 24 VAC 30-150-870 and 24 VAC 30-150-1560 of the Virginia Department of Transportation "Land Use Permit Manual," January, 1983 for marking of underground utilities.~~

C. All signs shall be maintained or replaced as necessary to be kept in a legible condition.

4 VAC 25-150-250. Blasting and explosives.

A. Applicability. This section governs all blasting on gas, oil or geophysical sites, except for:

1. Blasting being conducted as part of seismic exploration where explosives are placed and shot in a borehole to generate seismic waves; or

2. Use of a device containing explosives for perforating a well.

B. Certification.

1. ~~On or after September 25, 1992,~~ All blasting on gas, oil and geophysical sites shall be conducted by a person who is certified by the Board of ~~Coal~~ *Mineral* Mining Examiners, Board of ~~Mineral~~ *Coal* Mining Examiners, or by the Virginia Department of Housing and Community Development.

2. The director may accept a certificate issued by another state in lieu of the certification required in subdivision B 1 of this section, ~~providing the blaster submits documentation that the requirements for certification in the other state are substantially equivalent to those of the boards of examiners provided the Board of Mineral Mining Examiners, the Board of Coal Mining Examiners, or the Department of Housing and Community Development has approved reciprocity with that state.~~

C. Blasting safety. Blasting shall be conducted in a manner designed to prevent injury to persons, or damage to features described in the operations plan under 4 VAC 25-150-100 B 1 ~~b~~ of this chapter.

~~1. When an operator applies for a permit under which blasting is proposed, he shall indicate in the operations plan the distance to the nearest inhabited building.~~

~~2.~~ 1. When blasting is conducted within 200 feet of a pipeline or high-voltage transmission line, the blaster shall take due precautionary measures for the protection of the pipeline or high-voltage transmission line, and shall notify the owner of the facility or his agent that such blasting is intended.

~~3.~~ 2. Flyrock shall not be allowed to fall farther from the blast than one-half the distance between the blast and the nearest inhabited building, and in no case outside of the permitted area.

4. 3. When blasting near a highway, the blaster must ensure that all traffic is stopped at a safe distance from the blast. Blasting areas shall be posted with warning signs.

~~5.~~ 4. All blasting shall be conducted during daylight hours, one-half hour before sunrise to one-half hour after sunset, unless approved by the director.

~~6.~~ 5. Misfires.

a. The handling of a misfired blast shall be under the direct supervision of a certified blaster.

b. When a misfire occurs, the blaster shall wait for at least 15 minutes, or the period of time recommended by the manufacturer of the explosives and the

detonator, whichever is longer, before allowing anyone to return to the blast site.

~~7.~~ 6. Blasting signals.

a. Before a blast is fired, a warning signal audible to a distance of at least one-half mile shall be given by the blaster in charge, who shall make certain that all surplus explosives are in a safe place and that all persons are at a safe distance from the blast site or under sufficient cover to protect them from the effects of the blast.

b. A code of warning signals shall be established and posted in one or more conspicuous places on the permitted site, and all employees shall be required to conform to the code.

~~8.~~ 7. Explosives and detonators shall be placed in substantial, nonconductive, closed containers (such as those containers meeting standards prescribed by the Institute of Makers of Explosives) when brought on the permitted site. Explosives and detonators shall not be kept in the same container. Containers shall be posted with warning signs.

~~9.~~ 8. Storage of explosives and detonators on gas, oil or geophysical sites is allowed only with prior approval by the director.

~~10.~~ 9. The permittee shall report to the Division of Gas and Oil by the quickest means possible any theft or unaccounted-for loss of explosives. When reporting such a theft or loss, the permittee shall indicate other local, state and federal authorities contacted.

~~11.~~ 10. Damaged or deteriorated explosives and detonators shall be destroyed by a certified blaster in accordance with the manufacturer's recommendations.

D. Ground vibration.

1. The ground-vibration limits in this subsection shall not apply on surface property owned or leased by the permittee, or on property for which the surface owner gives a written waiver specifically releasing the operator from the limits.

2. Blasting without seismographic monitoring. Blasting may be conducted by a certified blaster without seismographic monitoring provided the maximum charge is determined by the formula, ~~$W = D^2/D_s$~~ , $W = (D/D_s)^2$ where W is the maximum weight of explosive in pounds per delay (eight milliseconds or greater); D is the actual distance in feet from the blast location to the nearest inhabited building; and D_s is the scaled distance factor to be applied without seismic monitoring, as found in Table 1.25.D-1.

Final Regulations

TABLE 1.25.D-1: MAXIMUM ALLOWABLE PEAK VELOCITY

Distance (D), from blasting site in feet	Maximum allowable peak particle velocity (Vmax) for ground vibration, in inches/second	Scaled Distance Factor (Ds) to be applied without seismic monitoring
0 to 300	1.25	50
301 to 5000	1.00	55
5001 and beyond	0.75	65

3. Blasting with seismographic monitoring.

a. A permittee may use the ground-vibration limits in Table 1.25.D-2 to determine the maximum allowable peak particle velocity. If Table 1.25.D-2 is used, a seismographic record including both particle velocity and vibration-frequency levels shall be provided for each blast. The method for the analysis of the predominant frequency contained in the blasting records shall be approved by the director before implementation of this alternative blasting level.

b. The permittee may choose to record every blast. As long as the seismographic records indicate particle velocities have remained within the limits prescribed in Tables 1.25.D-1 or 1.25.D-2, the permittee shall be considered to be in compliance with this subsection.

Table 1.25.D-2: ALTERNATIVE BLASTING LEVEL CRITERIA

(Source modified from figure B-1, Bureau of Mines R(8507)

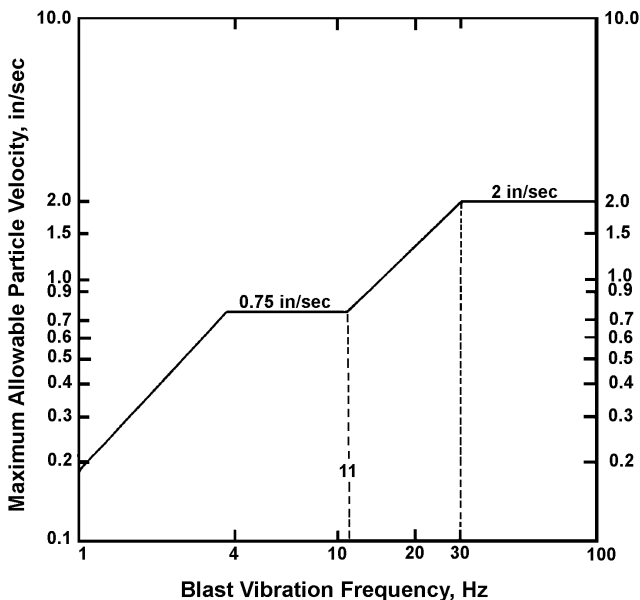

c. Ground vibration shall be measured as the particle velocity. Particle velocity shall be recorded in three mutually perpendicular directions. The maximum allowable peak particle velocity shall apply to each of the three measurements.

d. All seismic tests carried out for the purposes of this section shall be analyzed by a qualified seismologist.

e. All seismic tests carried out for the purposes of this section shall be conducted with a seismograph that has an upper-end flat frequency response of at least 200 Hz.

E. Airblast shall not exceed the maximum limits prescribed in Table 1.25.E-1 at the location of any inhabited building. The 0.1 Hz or lower, flat response or C-weighted, slow response shall be used only when approved by the director.

Table 1.25.E-1: AIRBLAST LIMITS

Lower Frequency Limit of measuring system, in Hz (+3db)	Measurement Level, in db
0.1 Hz or Lower Flat Response	134 Peak
2 Hz or Lower Flat Response	133 Peak
6 Hz or Lower Flat Response	129 Peak
C-weighted Slow Response	105 Peak

F. If the director concludes that blasting on a particular site has potential to create unsafe conditions, then he may:

1. Require the permittee to monitor ground vibration and airblast for all blasts on the site for a specified period of time;
2. Impose more-stringent limits on ground vibration and airblast levels than those specified in this section. The director may order the permittee to obtain an evaluation of the blast site by a vibration consultant or a technical representative of the explosives manufacturer before imposing a more-stringent limit. Blasting may not resume on the site being evaluated until the evaluation and recommendations are submitted to the director, and the director has approved given his approval.

G. Records.

1. The permittee shall keep records of all blasts, and these records shall contain the:
 - a. Name of company or contractor;
 - b. Location, date, and time of the blast;
 - c. Name, signature, and certification number of the blaster in charge;
 - d. Type of material blasted;
 - e. Number of holes; their burden; and spacing;
 - f. Diameter and depth of the holes;
 - g. Types of explosives used;
 - h. Total amount of explosives used per hole;
 - i. Maximum weight of explosives per delay period;
 - j. Method of firing and the type of circuit;

- k. Direction and distance in feet to *the* nearest inhabited building;
 - l. Weather conditions (including wind directions, etc.);
 - m. Height or length of stemming;
 - n. Description of any mats or other protection used;
 - o. Type of detonators used and delay periods used;
 - p. Any seismograph reports, including:
 - (1) *The* name and signature of *the* person operating the seismograph;
 - (2) *The* name of *the* person analyzing the seismograph record;
 - (3) The exact location of the seismograph in relation to the blast;
 - (4) The date and time of the reading; and
 - (5) The seismograph reading.
2. The permittee shall retain all records of blasting, including seismograph reports, at least three years, and. On request, *the permittee shall* make these records available for inspection by the director.

4 VAC 25-150-260. Erosion, sediment control and reclamation.

A. Applicability. Permittees shall meet the erosion and sediment control standards of this section whenever there is a ground disturbance for a gas, oil or geophysical operation. Permittees shall reclaim the land to the standards of this section after the ground disturbing activities are complete and the land ~~is~~ will not ~~to~~ be used for further permitted activities.

B. Erosion and sediment control plan. Applicants for a permit shall submit an erosion and sediment control plan as part of their operations plan. The plan shall describe how erosion and sedimentation will be controlled and how reclamation will be achieved.

C. Erosion and sediment control standards. Whenever ground is disturbed for a gas, oil or geophysical operation, the following erosion and sediment control standards shall be met.

1. All trees, shrubs and other vegetation shall be ~~removed~~ cleared as necessary before any blasting, drilling, or other site construction, including road construction, begins.

[*a. Cleared vegetation shall be either removed from the site, properly stacked on the permitted site for later use, burned, or placed in a brush barrier if needed to control erosion and sediment control. Only that material necessary for the construction of the permitted site shall be cleared. When used as a brush barrier the cleared vegetation shall be cut and windowed below a disturbed area so that the brush barrier will effectively control sediment migration from*

the disturbed area. The material shall be placed in a compact and uniform manner within the brush barrier and not perpendicular to the brush barrier. Brush barriers shall be constructed so that any concentrated flow created by the barrier is released into adequately protected outlets and adequate channels. Large diameter trunks, limbs, and stumps that may render the brush barrier ineffective for sediment control shall not be placed in the brush barrier.]

[*b.]* During construction of the project, topsoil sufficient to provide a suitable growth medium for permanent stabilization with vegetation shall be segregated and stockpiled. Soil stockpiles shall be stabilized in accordance with the standards of subdivisions C 2 and C 3 of this section to prevent erosion and sedimentation.

2. Except as provided for in subdivisions ~~C 7~~ C 5 and ~~C 44~~ C 12 c of this section, permanent or temporary stabilization measures shall be applied to denuded areas within ~~seven~~ 30 days ~~after~~ of achievement of final grade on ~~any portion~~ of the site unless the area will be redisturbed within 30 days.

a. If no activity occurs on a site for a period of 30 consecutive days, then stabilization measures shall be applied to denuded areas within seven days of the last day of the 30-day period.

~~a.~~ *b. Temporary stabilization measures shall be applied to denuded areas that may not be at final grade but will be left inactive for one year or less.*

~~b.~~ *c. Permanent stabilization measures shall be applied to denuded areas that are to be left inactive for more than one year.*

3. A permanent vegetative cover shall be established on denuded areas to achieve permanent stabilization on areas not otherwise permanently stabilized. ~~The vegetative cover shall be:~~ *Permanent vegetation shall not be considered established until a ground cover is uniform, mature enough to survive and will inhibit erosion.*

~~a. Diverse, effective and permanent;~~

~~b. Composed of species compatible with area; and~~

~~c. Capable of stabilizing the soil surface to prevent erosion.~~

~~4. Success of the permanent vegetative cover shall be judged on the effectiveness of the vegetation and the extent of cover compared to the cover occurring in similar natural vegetation of the area. Ground cover shall be considered successful if it has 90% or greater of the rate of coverage achieved by similar naturally occurring vegetation. Statistically valid sampling techniques, using a 90% statistical confidence interval such as a one-sided test with a 0.10 alpha error, shall be used for measuring percentage of cover.~~

Final Regulations

~~5. Where a pre-development site was unable to support vegetation, the permittee may apply for a variance to use alternate stabilization techniques.~~

~~6. 4. Temporary sediment control structures such as basins, traps, perimeter dikes berms or sediment barriers shall be constructed prior to beginning other ground disturbing activity, and shall be maintained until the site is stabilized.~~

~~7. 5. Stabilization measures shall be applied to earthen structures such as pits, impoundments, dikes and diversions immediately after sumps, diversions, dikes, berms and drainage windows within 30 days of installation.~~

~~8. 6. Sediment basins.~~

a. Surface runoff from disturbed areas that is composed of flow from drainage areas greater than or equal to three acres shall be controlled by a sediment basin. The sediment basin shall be designed and constructed to accommodate the anticipated sediment loading from the ground disturbing activity. The spillway or outfall system design shall take into account the total drainage area flowing through the disturbed area to be served by the basin.

b. If surface runoff that is composed of flow from other drainage areas is separately controlled by other erosion and sediment control measures, then the other drainage area is not considered when determining whether the three acre limit has been reached and a sediment basin is required.

~~9. 7. Cut and fill slopes shall be designed and constructed in a manner that will minimize erosion. No trees, shrubs, stumps or other woody material shall be placed in fill.~~

~~10. 8. Concentrated runoff shall not flow down cut or fill slopes unless contained within an adequate temporary or permanent channel, flume or slope drain structure.~~

~~11. 9. Whenever water seeps from a slope face, adequate drainage or other protection shall be provided.~~

~~12. 10. All storm sewer inlets that are made operable during construction shall be protected so that sediment-laden water cannot enter the conveyance system without first being filtered or otherwise treated to remove sediment.~~

~~13. 11. Before newly constructed stormwater conveyance channels or pipes are made operational, adequate outlet protection and any required temporary or permanent channel lining shall be installed in both the conveyance channel and receiving channel.~~

~~14. 12. Live watercourses.~~

a. When any construction required for erosion and sediment control, reclamation or stormwater management must be performed in a live watercourse, precautions shall be taken to minimize

encroachment, control sediment transport and stabilize the work area to the greatest extent possible. Nonerrodible material shall be used for the construction of causeways and cofferdams. Earthen fill may be used for these structures if armored by nonerrodible cover materials.

b. When the same location in a live watercourse must be crossed by construction vehicles more than twice in any six-month period, a temporary stream crossing constructed of nonerrodible material shall be provided.

c. The bed and banks of a watercourse shall be stabilized immediately after work in the watercourse is completed.

~~15. Underground gathering pipelines and utility lines shall be installed in accordance with the following standards:~~

~~a. 13. If more than 500 linear feet of trench is to be open at any one time on any continuous slope, then the trench shall be backfilled within 48 hours of being opened and ditchline barriers shall be installed at [no more than 500 feet] intervals [no more than the distance in the following table] and prior to entering watercourses or other bodies of water.~~

[Distance Barrier Spacing

Percent of Grade	Spacing of Ditchline Barriers in Feet
3-5	135
6-10	80
11-15	60
16+	40]

~~b. Effluent from dewatering operations shall be filtered or passed through an approved sediment trapping device, or both, and discharged in a manner that does not adversely affect flowing streams or off-site property.~~

~~16. 14. Where construction vehicle access routes intersect a paved highway or public road, provisions, such as surfacing the road, shall be made to minimize the transport of sediment by vehicular tracking onto the paved highway surface. Where sediment is transported onto a paved or public highway road surface, the road surface shall be cleaned immediately at by the end of each the day. Sediment shall be removed from the highway by shoveling or sweeping and transported back to an approved area on the permitted site. Washing shall be allowed only after sediment is removed in this manner.~~

~~17. 15. The design and construction or reconstruction of roads shall incorporate appropriate limits for grade, width, surface materials, surface drainage control, culvert placement, culvert size, and any other necessary design criteria required by the director to ensure control of erosion, sedimentation and runoff, and safety appropriate for their planned duration and use. This shall include, at a minimum, that roads are to be~~

located, designed, constructed, reconstructed, used, maintained and reclaimed so as to:

- a. Control or prevent erosion and siltation by vegetating or otherwise stabilizing all exposed surfaces in accordance with current, prudent engineering practices;
- b. Control runoff to minimize downstream sedimentation and flooding; and
- c. Use nonacid or nontoxic-forming substances in road surfacing.

~~18-~~ 16. Unless approved by the director, all temporary erosion and sediment control measures shall be removed within 30 days after final site stabilization or after the temporary measures are no longer needed. Trapped sediment and the disturbed soil areas resulting from the disposition of temporary measures shall be permanently stabilized within the permitted area to prevent further erosion and sedimentation.

D. *Final reclamation standards.*

1. All equipment, structures or other facilities not required for monitoring the site or permanently marking an abandoned well or corehole shall be removed from the site, unless otherwise approved by the director.

2. *Each pipeline abandoned in place shall be disconnected from all sources of natural gas or produced fluids and purged.*

~~2-~~A 3. *If final stabilization measures are being applied to access roads or ground-disturbed pipeline rights-of-way, or if the rights-of-way will not be redisturbed for a period of 30 days, water bar bars shall be placed across roads them at approximately a 30-degree angle angles at the head of all pitched grades and at intervals no more than the distance in the following table:*

Percent of Road Grade	Spacing of Water Bars in Feet
0-2	250
3 - 5	135
6 - 10	80
11 - 15	60
15+ 16+	40

~~3-~~ 4. The permittee shall notify the division when the site has been graded and seeded for final reclamation in accordance with ~~subdivisions~~ *subdivision C 3 and C 4* of this section. Notice may be given orally or in writing. The vegetative cover shall be successfully maintained for a period of two years after notice has been given before the site is eligible for bond release.

4- 5. If the land disturbed during gas, oil or geophysical operations will not be reclaimed with permanent vegetative cover as provided for in subsection C of this section, the permittee or applicant shall, in the operations plan, request a variance to these reclamation

standards and propose alternate reclamation standards and an alternate schedule for bond release.

E. The director may waive or modify any of the requirements of this section that are deemed inappropriate or too restrictive for site conditions. A permittee requesting a variance shall, in writing, document the need for the variance and describe the alternate measures or practices to be used. Specific variances allowed by the director shall ~~be documented in~~ *become part of* the operations plan. The director shall consider variance requests judiciously, keeping in mind both the need of the applicant to maximize cost effectiveness and the need to protect off-site properties and resources from damage.

4 VAC 25-150-270. Stormwater management.

A. This section shall apply whenever an applicant or permittee must complete an erosion and sediment control plan under 4 VAC 25-150-260 ~~of this chapter~~. The erosion and sediment control plan shall also describe how stormwater runoff will be managed in accordance with the standards of this section.

B. Areas downstream from permitted sites shall be protected from sediment disposition, erosion and damage due to increases in volume, velocity and peak flow rates of stormwater runoff for the stated frequency storm of 24-hour duration in accordance with the following:

1. Increased volumes of sheet flows *or concentrated flows* that may cause erosion and sedimentation on adjacent property shall be diverted to a stable outlet, adequate channel or a sediment control, detention or retention facility.

2. Adequacy of all channels and pipes shall be verified in the following manner:

a. The applicant shall demonstrate that the total drainage area to the point of analysis within the channel is ~~one hundred~~ *100* times greater than the contributing drainage area of the site in question; or

b. The receiving channel or pipe shall be analyzed as follows:

(1) Natural channels shall be analyzed, using data for a two-year ~~frequency~~ storm, to verify that stormwater will not overtop channel banks ~~nor~~ *or* cause erosion of *the* channel bed or banks.

(2) All previously constructed man-made channels shall be analyzed, using data for a 10-year ~~frequency~~ storm, to verify that stormwater will not overtop its banks and, using data for a two-year ~~frequency~~ storm, to demonstrate that stormwater will not cause erosion of *the* channel bed or banks.

(3) Pipes and storm sewer systems shall be analyzed, using data from a 10-year ~~frequency~~ storm, to verify that stormwater will be contained within the pipe or system. A downstream stability analysis at the outfall of the pipe or storm sewer system shall *also* be performed.

Final Regulations

3. All hydrologic analyses shall be based on the existing watershed characteristics and the ultimate development condition of the site.

4. If the applicant chooses an option that includes stormwater detention or retention, then the plan must provide for maintenance of the detention or retention facilities. The plan shall set forth the maintenance requirements of the facility and the person responsible for performing the maintenance.

5. Outflows from a sediment basin, stormwater management facility or other concentrated runoff leaving a permitted site shall be discharged into an adequate channel.

~~6. If an existing natural receiving channel or previously constructed man-made receiving channel is not adequate, the applicant shall:~~

~~a. Improve the natural channel to a condition where a 10-year frequency storm will not cause the channel to overtop its banks and a two-year frequency storm will not cause erosion of the channel bed or banks;~~

~~b. Develop a site design that will not cause the pre-development peak runoff rate from a two-year storm to increase when runoff outfalls into a natural channel or will not cause the pre-development peak runoff rate from a 10-year storm to increase when runoff outfalls into a man-made channel; or~~

~~c. Provide a combination of channel improvement, stormwater detention or retention or other measures, approved by the division, to prevent downstream erosion.~~

C. Stormwater runoff which has been contaminated by or come into contact with overburden, raw material, intermediate products, finished products, byproducts or wastes from gas, oil or geophysical operations located on the permitted site shall be managed in accordance with a plan approved by the director.

D. The director may waive or modify any of the requirements of this section that are deemed inappropriate or too restrictive for site conditions. ~~A permittee requesting a variance shall, in writing, The permittee's written request for a variance shall~~ document the need for the variance and describe the alternate measures or practices to be used. Specific variances allowed by the director shall be documented in the operations plan. The director shall consider variance requests judiciously, keeping in mind both the need of the applicant to maximize cost effectiveness and the need to protect off-site properties and resources from damage.

4 VAC 25-150-280. Logs and surveys.

A. Each permittee drilling a well or corehole shall complete a driller's log, a gamma ray log or other log showing the top and bottom points of geologic formations and any other log required under this section. The driller's log shall state, at a minimum, the character, depth and thickness of geological formations encountered, including

groundwater bearing strata, coal seams, mineral beds and gas or oil bearing formations.

~~B. In any case where~~ *When* a permittee or the director ~~has identified~~ *identifies* that a well or corehole is to be drilled or deepened in an area of the Commonwealth which is known to be underlain by coal seams, the following shall be required:

1. The vertical location of coal seams in the borehole shall be determined and shown in the driller's log and gamma ray or other log.

2. The horizontal location of the borehole in coal seams shall be determined through an inclination survey from the surface to the lowest known coal seam. Each inclination survey shall be conducted as follows:

a. The first survey point shall be taken at a depth not greater than the ~~shallowest~~ *most shallow* coal seam; and

b. Thereafter shot points shall be taken at each coal seam or at intervals of 200 feet, whichever is less, to the lowest known coal seam.

3. Prior to drilling any borehole into a coal seam in which active mining is being conducted within 500 feet of where the borehole will penetrate the seam, the permittee shall conduct an inclination survey to determine whether the deviation of the bore hole exceeds one degree from true vertical. If the borehole is found to exceed one degree from vertical, then the permittee shall:

a. Immediately cease operations;

b. Immediately notify the coal owner and the division;

c. Conduct a directional survey to drilled depth to determine both horizontal and vertical location of the borehole; and;

d. Unless granted a variance by the director, correct the borehole to within one degree of true vertical.

4. Except as provided for in subdivision B 3 of this section, if the deviation of the borehole exceeds one degree from true vertical at any point between the surface and the lowest known coal seam, then the permittee shall:

a. Correct the borehole to within one degree ~~from~~ *from* true vertical; or

b. Conduct a directional survey to the lowest known coal seam and notify the coal owner of the actual borehole location.

5. The director may grant a variance to the requirements of subdivisions B 3 and B 4 of this section only after the permittee and coal owners have jointly submitted a written request for a variance stating that a directional survey or correction to the borehole is not needed to protect the safety of any person engaged in active coal mining or to the environment.

6. The director may, at any time until 30 days after a permittee has filed the completion report required in 4 VAC 25-150-360 of this chapter require that a directional survey be conducted by the permittee. If the director finds that the lack of assurance of the horizontal location of the bore of a well or corehole to a known coal seam poses a danger to persons engaged in active coal mining or the lack of assurance poses a risk to the public safety or the environment, the director may, until 30 days after a permittee has filed the completion report required in 4 VAC 25-150-360, require that a directional survey be conducted by the permittee.

7. The drillers' log shall be updated on a daily basis. The driller's log and results of any other required survey shall be kept at the site until drilling and casing or plugging a dry hole or corehole are completed.

4 VAC 25-150-290. Actual well or corehole location.

A. The actual horizontal surface location of the well shall be within three feet of the permitted location designated on the well plat, *except where an operator has stated that the location may vary up to 10 feet in the notice as required in § 45.1-361.30 of the Code of Virginia.*

~~B. The permittee shall submit written certification on a form prescribed by the director, within two days after inception of drilling, that the actual well location conforms to the location standards of this section.~~

~~B. The permittee shall survey the actual location of the well which may be made from a minimum of two temporary points not disturbed during development of the well or site and shown on the plat submitted with the permit application. The permittee shall submit an updated plat, certified by a licensed land surveyor or licensed professional engineer, showing the actual well location certified to be within three feet of the permitted location, or within 10 feet as provided for in subsection A of this section. This updated plat shall be included with the drilling report submitted in accordance with 4 VAC 25-150-360 of this chapter.~~

4 VAC 25-150-300. Pits.

A. General requirements.

~~1. All fluids from a well or corehole shall be handled in a properly constructed, lined pit. A pit may not be used for more than one well or corehole. The director may approve a variance if a permittee wishes to use another method to manage fluids from a well or corehole, or to place fluids from more than one well in a pit if comparable protection will be provided.~~

~~2. 1. Pits are to be temporary in nature, and are to be reclaimed when the operations using the pit are complete.~~

~~3. 2. Pits may not be used as erosion and sediment control structures or stormwater management structures, and surface drainage may not be directed into a pit unless the pit meets the requirements for erosion and sediment control structures in 4 VAC 25-~~

~~150-260 of this chapter or stormwater management structures in 4 VAC 25-150-270 of this chapter.~~

~~3. Pits shall have a properly installed and maintained liner or liners made of 10mil or thicker high-density polyethylene or its equivalent.~~

~~B. Operations plan requirements.~~

~~1. The operations plan shall contain sufficient information to adequately describe the location, specifications, operation, maintenance, draining and reclamation of the pit. The description shall show how the pit will meet the requirements of this section and the requirements for draining and reclaiming the pit of 4 VAC 25-150-420 and 4 VAC 25-150-430 of this chapter.~~

~~2. When a pit is to be used as an erosion and sediment control structure or as a stormwater management structure, the operations plan must show how the pit will meet the requirements of 4 VAC 25-150-260 and 4 VAC 25-150-270 of this chapter, and must contain detailed drawings of the pit, since pit size and design may need to be altered from that normally used in drilling.~~

~~C. B. Technical requirements.~~

1. Pits shall be constructed of sufficient size and shape to contain all fluids and maintain a two-foot freeboard.

2. Pits shall be lined in accordance with the requirements for liners in 4 VAC 25-150-430 of this chapter *subdivision A 3 of this section*. If drilling solids are not to be disposed of in the pit, the permittee may request a variance to the liner specifications in 4 VAC 25-150-430.

~~D. C. Operational requirements.~~

1. The integrity of lined pits must be maintained until the pits are reclaimed or otherwise closed. Upon failure of the lining or pit, the operation shall be shut down until the liner and pit are repaired or rebuilt. The permittee shall notify the division, by the quickest available means, of any failure of the lining or pit leak.

2. Motor oil and, to the extent practicable, crude oil shall be kept out of the pit. Oil shall be collected and disposed of properly. Litter and other solid waste shall be collected and disposed of properly and not thrown into the pit.

3. At the conclusion of drilling and completion operations or after a dry hole, well or corehole has been plugged, the pit shall be drained in a controlled manner and the fluids disposed of in accordance with 4 VAC 25-150-420 of this chapter. If the pit is to be used for disposal of solids, then the standards of 4 VAC 25-150-430 of this chapter shall be met.

4 VAC 25-150-310. Tanks.

A. All tanks installed on or after September 25, 1991, shall be designed and constructed to contain the fluids to be stored in the tanks and prevent unauthorized discharge of fluids.

Final Regulations

B. All tanks shall be maintained in good condition and repaired as needed to ensure the structural integrity of the tank.

C. Every permanent tank or battery of tanks shall be surrounded by a containment dike or firewall with a capacity of 1½ times the volume of the single tank or largest tank in a battery of tanks.

D. Dikes and firewalls shall be maintained in good condition, and the reservoir shall be kept free from brush, water, oil or other fluids.

E. Permittees shall inspect the structural integrity of tanks and tank installations, at a minimum, annually. The report of the annual inspection shall be maintained by the permittee for a minimum of three years and be submitted to the director upon request.

F. Load lines shall be properly constructed and operated on the permitted area.

4 VAC 25-150-320. Blowout prevention.

A. Applicability. All wells shall be equipped to control formation pressure during drilling and servicing as follows:

1. Blowout prevention equipment is required when formation pressures of 1,000 pounds or greater are encountered or are expected to be encountered, or when drilling in an area where there is no prior knowledge of the formation pressures to be encountered.

2. A diverter system is required when formation pressures are expected to be less than 1,000 pounds.

B. All blowout preventers, diverters, choke lines, kill lines and manifolds shall be installed above ground level. Casing heads and optional spools may be installed below ground level provided they are readily accessible.

C. The diverter, chokelines and kill lines shall be anchored, tied or otherwise secured to prevent whipping resulting from pressure surges.

D. Pressure ratings.

1. All pipe fittings, valves and unions placed on or connected with the well or corehole, as well as blowout prevention equipment, casing, casing head, drill pipe, or tubing shall have a minimum working pressure rating of 110% of the maximum anticipated pressure that the material will be exposed to and shall be in good working condition.

2. All ram type blowout preventers and related equipment shall be tested to 110% of the maximum anticipated formation pressure, not to exceed 70% of the rated burst pressure of the casing that the blowout preventers are connected to before being placed in service. Annular type blowout preventers shall be tested in conformance with the manufacturer's published instructions, or those of a licensed professional engineer, prior to use.

E. While in service, blowout prevention equipment shall be visually inspected daily. A preventer operating test shall be performed at least once on all the blowout prevention equipment except the blind rams which shall be tested on each round trip.

~~F. All employees on the rig shall be trained, knowledgeable and able to properly operate the blowout preventer system. In addition, when blowout prevention equipment is installed, at least one person who is certified in blowout prevention and well control procedures by a school of blowout prevention acceptable to the director shall be responsible for the proper testing and operations of the blowout preventers and related equipment, shall be on the well site at least once per day during all drilling or servicing operations and otherwise shall be present on the well site within one hour of any incident which involves well control.~~

~~G. Where blowout prevention and related equipment are installed, they shall be maintained in serviceable condition. When repairs or other work must be performed to the blowout prevention equipment, drilling and servicing operations must stop until the blowout prevention equipment is returned to service.~~

H. A record of all tests on the equipment shall be kept at the rig for inspection by the director until drilling or servicing operations have been completed.

4 VAC 25-150-330. Swabbing, perforating and wireline operations.

A. All wells and coreholes shall be cleaned into properly constructed pits or containers at a safe distance from the rig floor and from any potential fire hazard.

B. Possible sources of ignition, such as all engines and motors not essential to the swabbing operation, shall be shut down while swabbing operations are being conducted.

C. Swabbing operations shall be conducted only during daylight hours or with adequate illumination.

D. Swabbing shall be conducted so that fluids are routed through a closed-flow system to the maximum extent possible.

~~E. No employee shall be permitted in or on the derrick during the time the swabbing line or other wireline is being run within the hole.~~

~~F. When handling a wireline which will recoil when released, the loose end shall not be left unsecured.~~

~~G. E.~~ All oil savers shall be of the type that do not require a person to be near the lubricator or wellhead to control the oil saver.

~~H. F.~~ All swabbing lines, blow down lines or flow lines to pits or tanks shall be securely anchored. Whenever hydrocarbons or other volatile fluids may be expected, these lines shall extend a ~~minimum~~ safe distance of ~~50 feet~~ from the well and away from any other source of ignition.

~~I. G.~~ On wells where there is a possibility of flow during swabbing or other wireline operations, a lubricator shall be

used that will allow the removal of the swabbing or other tools without venting gas from the well.

~~↳~~ H. There shall be no radio or radio-phone transmitters operated where perforating operations are in progress. Warning signs shall be conspicuously placed at entrances to work sites, which shall be at a minimum, 200 feet from the operation where perforating is being done.

~~↳~~ I. Upon the conclusion of perforating operations, the work area shall be inspected and all explosive material and scraps shall be placed in containers and removed from the site.

~~↳~~ J. Electrical grounding between the well head, service unit, and rig structure shall be made prior to operating tools using explosives.

4 VAC 25-150-340. Drilling fluids.

A. Operations plan requirements. Applicants for a permit shall provide, ~~in the operations plan required in 4 VAC 25-150-100 of this chapter prior to commencing drilling,~~ documentation that the water meets the requirements of subsection B of this section, and a general description of the additives and muds to be used in all stages of drilling. Providing that the requirement in 4 VAC 25-150-340 C is met, variations necessary because of field conditions may be made with prior approval of the director and shall be documented in the driller's log.

B. Water quality in drilling.

1. Before the water protection string is set, permittees shall use one of the following sources of water in drilling that:

~~a. Is from a source meeting the requirements of the State Water Control Board regulations entitled "Groundwater Standards" and "Water Quality Criteria for Groundwater (9 VAC 25-260-10 et seq.);~~

~~b. a. Water that is from a water well at or spring located on the drilling site; or~~

~~c. Is from a source that equals or exceeds the quality of the water at the site, which shall be documented by:~~

~~(1) An analysis of water from the closest source (spring or well) within 500 feet of the proposed drilling location;~~

~~(2) An analysis of the water to be used; and if needed~~

~~(3) A plan for treating the drilling water prior to use to a level meeting the standards of this section.~~

~~b. Conduct an analysis of groundwater within 500 feet of the drilling location, and use:~~

~~(1) Water which is of equal or better quality than the groundwater; or~~

~~(2) Water which can be treated to be of equal or better quality than the groundwater. A treatment plan must be included with the application if water is to be treated.~~

If, after a diligent search, a groundwater source (such as a well or spring) cannot be found within 500 feet of the drilling location, the applicant may use water meeting the parameters listed in the Department of Environmental Quality's "Water Quality Criteria for Groundwater," 9 VAC 25-260-230 et seq. The analysis shall include, but is not limited to, the following items:

- (1) Chlorides;*
- (2) Total dissolved solids;*
- (3) Hardness;*
- (4) Iron;*
- (5) Manganese;*
- (6) PH;*
- (7) Sodium; and*
- (8) Sulfate.*

2. After the water-protection string is set, permittees may use waters that do not meet the standards of subdivision B 1 of this section.

C. Drilling muds. No permittee may use an oil-based drilling fluid or other fluid which has the potential to cause acute or chronic adverse health effects on living organisms unless a variance has been approved by the director. Permittees must explain the need to use such materials and provide the material data safety sheets. In reviewing the request for the variance, the director shall consider the concentration of the material, the measures to be taken to control the risks, and the need to use the material. Permittees shall also identify what actions will be taken to ensure use of the additives will not cause a lessening of groundwater quality.

4 VAC 25-150-350. Gas, oil or geophysical operations in hydrogen sulfide areas.

A. Applicability. ~~4.~~ This section shall apply to every permittee who drills or operates a well or drills a corehole:

- ~~a. 1. In areas of unknown hydrogen sulfide conditions;~~
- ~~b. 2. Below the base of the devonian shale; or~~
- ~~c. 3. In areas where the hydrocarbons contain gas with a concentration of 100 parts per million (ppm) or greater of hydrogen sulfide as a constituent of the gas.~~

B. Permittees shall not remove hydrocarbons with a hydrogen sulfide concentration of 100 parts per million or greater from the well site where they were produced unless:

- 1. The hydrocarbons have been cleaned on-site so that the hydrogen sulfide concentration is less than 100 parts per million; or
- 2. The permittee has received a variance from the director.

C. General requirements.

Final Regulations

1. Each permittee subject to this section shall determine the hydrogen sulfide concentration in the hydrocarbons by a test approved by the director such as a test in accordance with ASTM Standard D-2385-66, or GPA Plant Operation Test Manual C-1, GPA Publication 2265-68.

2. Automatic hydrogen sulfide detection and alarm equipment that will warn of the presence of hydrogen sulfide gas shall be utilized at the site.

~~3.~~ **D. Materials and equipment provision.**

~~a.~~ 1. For new construction or modification of facilities, including materials and equipment to be used in drilling and workover operations, permittees shall only use metal components, approved by the director, which have been selected and manufactured so as to be resistant to hydrogen sulfide stress cracking under the operating conditions for which their use is intended. This requirement may be met by use of components that satisfy the requirements of NACE Standard MR-01-75 and API RP-14E, §§ 1.7(c), 2.1(c) and 4.7. The handling and installation of materials and equipment used in hydrogen sulfide service are to be performed in such a manner so as not to induce susceptibility to sulfide stress cracking.

~~b.~~ 2. Other materials and equipment, including materials and equipment used in drilling and workover operations, may be used for hydrogen sulfide service provided such materials and equipment are proved, as the result of advancements in technology or as the result of control and knowledge of operating conditions such as temperature and moisture content, suitable for the use intended and where such usage is technologically acceptable as good engineering practice, and the director has approved a variance for the materials and equipment for the specific uses.

~~c.~~ 3. In the event of a failure of any element of an existing system as the result of hydrogen sulfide stress cracking, the compliance status of the system shall be determined by the director after the operator has submitted a detailed written report on the failure to the director.

~~D.~~ **E. Reporting provision.** The permittee shall report the hydrogen sulfide concentrations of the hydrocarbon in any well or corehole where the hydrogen sulfide concentration is equal to or exceeds 100 parts per million with the drilling report under 4 VAC 25-150-360 of this chapter, or with the plugging affidavit for coreholes under 4 VAC 25-150-460 of this chapter.

4 VAC 25-150-360. Drilling, completion and other reports.

A. Each permittee conducting drilling shall file, on a form prescribed by the director, a drilling report within 30 days after a well reaches total depth.

B. Each permittee drilling a well shall file, on a form prescribed by the director, a completion report within 30 days after the well is completed.

C. The permittee shall file the driller's log, the results of any other log or survey required to be run in accordance with this chapter *or by the director*, and the plat showing the actual location of the well with the drilling report, unless they have been filed earlier.

D. The permittee shall, within two years of reaching total depth, file with the division the results of [all any] gamma ray, density, neutron and induction logs, or their equivalent, that have been conducted on the wellbore in the normal course of activities [that have not previously been required to be filed].

4 VAC 25-150-380. Accidents, spills and unpermitted discharges.

A. Accidents. A permittee shall, by the quickest available means, notify the director in the event of any fire, blowout, pit failure, hydrogen sulfide release, unanticipated loss of drilling fluids, or other accident resulting in an actual or potential imminent danger to the environment, public safety or welfare, ~~and~~. *The permittee shall take immediate action to abate the actual or potential danger. The permittee shall submit a written report shall be submitted within seven days of the incident. The written report shall contain containing:*

1. A description of the incident and its cause;
2. The date, time and duration of the incident;
3. ~~What~~ *A description of the steps that have been taken to date; and*
4. ~~What~~ *A description of the steps are planned to be taken to prevent a recurrence of the incident.*

B. On-site spills.

1. A permittee shall take all reasonable steps to prevent, minimize, or correct any spill or discharge of fluids on a permitted site which has a reasonable likelihood of adversely affecting human health or the environment. All actions shall be consistent with the requirements of an abatement plan, if any has been set, in a notice of violation or closure, emergency or other order issued by the director.

2. A permittee shall orally report on-site spills or unpermitted discharges of fluids which are not required to be reported in subsection A of this section to the division within 24 hours. The oral report shall provide all available details of the incident, including any adverse ~~effects~~ *effects* on any person or the environment. A written report shall be submitted within seven days of the spill or unpermitted discharge. The written report shall contain:

- a. A description of the incident and its cause;
- b. The period of release, including exact dates and times;

~~c. What A description of the steps have been taken to date; and~~

~~d. What A description of the steps are planned to be taken to reduce, eliminate and prevent a recurrence of the release.~~

C. Off-site spills. 4- Permittees shall submit a written report of any spill or unpermitted discharge of fluids that originates off of a permitted site with the monthly report under 4 VAC 25-150-210 ~~of this chapter~~. The written report shall contain:

~~a-~~ 1. A listing of all agencies contacted about the spill or unpermitted discharge; and

~~b-~~ 2. All actions taken to contain, clean up or mitigate the spill or unpermitted discharge.

4 VAC 25-150-390. Shut-in wells.

~~A. If a well is shut in or otherwise not produced during any month, it shall be so noted on the monthly report submitted by the permittee.~~

~~B.~~ A. If a well is shut-in or otherwise not produced for a period of 12 consecutive months, the permittee shall measure the shut-in pressure on the production string or strings. If the well is producing on the backside or otherwise through the casing, the permittee shall measure the shut-in pressure on the annular space.

~~C.~~ B. A report of the pressure measurements shall be maintained by the permittee for a minimum of three years and be submitted to the director upon request.

4 VAC 25-150-400. Measurement of gas and oil.

A. Natural gas.

1. Each producer shall measure all gas produced from each well, or as prescribed by the director, using a method permitting the computation of volumes, in Mcf. This requirement may be met by use of the standards in:

a. "Orifice Metering of Natural Gas," ANSI/API 2530, American Gas Association, 1978;

b. "AGA Gas Measurement Manual, Part 2: Displacement Measurement," American Gas Association, 1977; or

c. "AGA Gas Measurement Manual, Part 3: Gas Turbine Metering," American Gas Association, 1989.

2. The director may require use of meters at designated places to obtain accurate records of the production of gas.

B. Oil. Each permitted *oil* operation ~~with oil production shall be provided with and~~ use sufficient ~~tankage tanks~~ meters to measure ~~all the volume of~~ oil produced. In no case shall meters be the sole means of measuring oil, unless such metering ~~operation~~ is conducted in accordance with a method approved by the director such as the API Manual of Petroleum Measurement Standards, 1981, Chapter 6.1, LACT Systems. A permittee may request a variance from

the director to use a gauge tank to check the readings of meters.

4 VAC 25-150-410. Venting and flaring of gas; escape of oil.

A. It shall be unlawful for any permittee to allow crude oil or natural gas to escape from any well, gathering pipeline or storage tank except as provided for in this section or in an approved operations plan. The permittee shall take all reasonable steps to shut in the gas or oil in the well, or make the necessary repairs to the well, gathering pipeline or storage tank to prevent the escape. All actions shall be consistent with the requirements of an abatement plan, if any has been set, in a notice of violation or closure, emergency or other order issued by the director.

B. A permittee shall drill or repair a well with special diligence so that waste of gas or oil from the well shall not continue longer than reasonably necessary *under the following circumstances*:

~~1. When in the process of drilling a well, during drilling,~~ gas or oil is found in the well and the permittee desires to continue to search for gas or oil by drilling deeper; or

~~2. When it becomes necessary to make~~ making repairs to any well producing gas or oil, commonly known as cleaning out; and.

~~3. When in either event it is necessary for the gas or oil in the well to escape therefrom during the process of drilling or making repairs. The permittee shall take all reasonable steps to shut in the gas or oil well and prevent escape of gas or oil during any temporary suspension of the deeper drilling or repair.~~

C. No gas shall be flared or vented from a well for more than seven days after completion of the well except *in these circumstances*:

1. When a well must be blown to remove accumulated formation fluid which has restricted efficient production, or *the well must be* otherwise cleaned out as provided for in subsection B of this section;

2. For the safety of mining operations;

3. For any activity excluded in the definition of "waste" under § 45.1-361.1 of the Act; or

4. For any other operational reason approved in advance by the director.

D. In all cases where both gas and oil are found and produced from the same stratum, the permittee shall use special diligence to conserve and save as much of the gas as is reasonably possible.

E. Venting shall only be used when flaring is not safe or not feasible.

Final Regulations

4 VAC 25-150-420. Disposal of pit and produced fluids.

A. Applicability. ~~All fluids from a well, pipeline or corehole shall be handled in a properly constructed pit, tank or other type of container approved by the director.~~

A permittee shall not ~~produce gas or oil from any well dispose of fluids from a well, pipeline or corehole until the~~ director has approved the permittee's plan for permanent disposal of ~~pit or produced~~ the fluids. Temporary storage of pit or produced fluids is allowed with the approval of the director. Other fluids shall be disposed of in accordance with the operations plan approved by the director.

B. Application and plan. ~~The director must approve an operator's application, maps and narrative describing the method to be used for permanent disposal of fluids before the permittee may land apply any fluids on the permitted site or remove any fluids from a permitted site. An operator may submit the application on a form prescribed by the director and accompanied by maps and narrative with the original permit application, or with an application for a permit modification. The application, maps and narrative shall become part of the operator's operations plan. The permittee shall submit an application for either on-site or off-site permanent disposal of fluids on a form prescribed by the director. Maps and a narrative describing the method to be used for permanent disposal of fluids must accompany the application if the permittee proposes to land apply any fluids on the permitted site. The application, maps, and narrative shall become part of the permittee's operations plan.~~

C. Removal of free fluids. ~~Fluids shall be removed from the pit to the extent practical so as to leave no free fluids. In the event that there are no free fluids for removal, the permittee shall report this on the form provided by the director.~~

~~C. D.~~ D. On-site disposal. The following standards for on-site land application of fluids shall be met:

~~1. Permittees shall comply with the requirements of the "Antidegradation Policy for Groundwater," of the State Water Control Board "Groundwater Standards (9 VAC 25-260-10 et seq.)" Fluids to be land-applied shall meet the parameters listed in the Department of Environmental Quality's "Water Quality Criteria for Groundwater" (9 VAC 25-260-230 et seq.).~~

2. Land application of fluids shall be confined to the permitted area.

3. Fluids shall be applied in a manner which will not cause erosion or runoff. The permittee shall take into account site conditions such as slope, soils and vegetation when determining the rate and volume of land application on each site. ~~As part of the application narrative, the permittee shall show the calculations, in the application narrative, used to determine the maximum rate of application for each site.~~

~~4. Fluids shall not be applied to areas that are not stabilized.~~

~~5.~~ 4. Fluid application shall not be conducted when the ground is: *saturated, snow-covered or frozen.*

~~a. Saturated;~~

~~b. Snow covered; or~~

~~c. Frozen.~~

~~6.~~ 5. The following buffer zones shall be maintained unless a variance has been granted by the director:

a. Fluid shall not be applied closer than 25 feet from highways or property lines not included in the acreage shown in the permit.

b. Fluid shall not be applied closer than 50 feet from surface watercourses, wetlands, natural rock outcrops, or sinkholes.

c. Fluid shall not be applied closer than 100 feet from water supply wells or springs.

~~7.~~ 6. The permittee shall monitor vegetation for two years after the last fluid has been applied to a site. If any adverse effects are found, the permittee shall report the adverse effects in writing to the division.

~~8.~~ 7. The director may require monitoring of groundwater quality on sites used for land application of fluids to determine if the groundwater has been degraded.

~~D.~~ E. Off-site disposal of fluids.

1. Each permittee using an off-site facility for disposal of fluids shall submit:

a. A copy of a valid permit for the disposal facility to be used; and

b. Documentation that the facility will accept the fluids.

2. Each permittee using an off-site facility for disposal of fluids shall use a waste-tracking system to document the movement of fluids off of a permitted site to their final disposition. ~~The system shall meet the following standards: Records compiled by this system shall be available for inspection on request.~~

~~a. A form recording the names, addresses and phone numbers of the permittee, hauler and the disposal facility operator, a description of the volume and type of waste fluids, and the times and dates the fluids were collected, hauled and disposed of shall be used.~~

~~b. The form shall be completed as needed by the permittee, hauler and disposal facility operator.~~

~~c. The waste tracking form shall include certifications from the hauler and disposal facility operator that no wastes were dumped illegally or at a location or facility not designated in the approved off-site disposal plan, and that no hazardous wastes were mixed with the fluids during transport.~~

d. The permittee shall retain the records of disposal for three years after the shipment date and submit the records to the director upon request.

e. The permittee shall report any discrepancy in fluid descriptions or place of origin or any significant discrepancy in the volume that arise between collection and disposition of the fluids.

4 VAC 25-150-430. Disposal of solids.

A. Applicability. All drill cuttings and solids ~~remaining after completion or plugging~~ shall be disposed of in the on-site pit as provided in subsection C ~~or D~~ of this section or as approved by the director. All other solid waste from gas, oil or geophysical operations shall be disposed of in a facility permitted to accept the *that* type of waste being disposed of.

B. Plan. Each operator shall submit a description of how drill cuttings and solids will be disposed of in ~~his~~ *the* operations plan.

C. Disposal in a pit. Drill cuttings and solids ~~remaining after completion or plugging~~ may be disposed of on-site in an approved pit, without testing of the material, ~~as follows:~~

~~1. Pits shall have a properly installed and maintained liner or liners made of:~~

~~a. A single liner made of a 20 mil or thicker, high density polyethylene; or~~

~~b. A double liner system made of two, 10 mil thick, high density polyethylene sheets separated by 8 to 12 inches of dirt or other material.~~

~~2. Fluids shall be drained from the pit to leave no free liquids.~~

~~3. The remaining drill cuttings and solids shall be covered with a liner meeting the standards of subdivision C 1 of this section 4 VAC 25-150-300, or a low-permeability clay cap, and shall be covered by soil. The combination of soil and liner or cap shall be at least four feet thick, capable of shielding the ~~drill~~ cuttings and solids remaining in the pit, suitable for supporting vegetation, and sloped to prevent ponding.~~

~~D. Variance based on representative data.~~

~~An operator may propose alternative liner specifications based on test data representative of the site and type of operation. The test data may be used to support variance requests for more than one well. However, no variance based on representative instead of actual data may be granted for the disposal of drill cuttings and solids when the well is drilled using drilling muds or additives subject to the requirements of 4 VAC 25-150-340 C of this chapter. Before applying for this variance, the operator must first have obtained the approval of the director of the testing methodology proposed to support the variance request or requests. Requests for approval of the testing program must identify the testing protocols, reporting schedules, identification of the geographic area for which the results will~~

~~apply, and demonstration that the sample is of sufficient size and characterization to be representative of the area.~~

4 VAC 25-150-435. Plugging for abandonment or plug-back operations.

A. Permit requirements; variances.

1. *Plugging operations shall not commence until a detailed plugging plan has been submitted to and approved by the director. A permit modification is required if the well was not previously permitted for plugging.*

2. *Any person may file an application with the director to replug a previously plugged well in any manner permissible under provisions of this section to facilitate the safe mining-through of the well at a later date. The application shall be treated in all respects like any other application for a permit under § 45.1-361.29 of the Code of Virginia.*

3. *The director may, upon application by the permittee, approve a variance to the prescribed plugging methods for the following reasons if it is determined that the alternate plan meets the requirements of the Act:*

a. The coal owner or operator requests a special plugging program to facilitate mine safety, mining through the well, or to obtain approval from another governmental agency for the safe mining-through of a well. The application for a variance must include documentation of the request from the coal owner or operator.

b. The permittee has obtained written authorization from the coal owner or operator for alternate plugging of the coal-bearing section. The application for a variance must include documentation of approval by the coal owner or operator.

c. Downhole conditions such as junk in the hole, a stuck or collapsed casing, caving or other adverse conditions which would prevent proper execution of the prescribed plugging methods.

d. A permittee presents an alternate plugging plan which may differ in method from that prescribed herein, but which will achieve the desired result.

B. *Plugging in open hole. When a well or section of a well without casing is to be plugged or plugged back, it shall be sealed and filled as prescribed in this section.*

1. At a point approximately 20 feet above each oil, gas or water-bearing stratum in open hole, a plug shall be placed so as to completely seal the wellbore. Whenever two or more gas or oil stratum are not widely separated, they may be treated as a single stratum and plugged accordingly. Cement plugs shall be at least 100 feet in length. At least 20 feet of cement shall be placed on top of open hole bridge plugs.

Final Regulations

2. At each coal seam, a cement plug shall be placed from not less than [40 50] feet below the base of the coal to not less than [20 50] feet above the top of the coal. Whenever two or more coal seams are not widely separated, they may be treated as a single seam and plugged accordingly. This subsection applies only to coal seams which occur at a depth compatible with mining. Coal-bearing sections at greater depths may be plugged in accordance with subdivision B 1 of this section.

3. If a source of groundwater capable of having a beneficial use is exposed in open hole below surface (water-protection) casing, a cement plug at least 100 feet in length shall be placed below the base of the lowest such groundwater zone.

4. A cement plug of a minimum length of 100 feet shall be placed across the shoe of the surface (water-protection) casing. The plug shall be placed so as to have approximately equal lengths in open hole and inside casing. If the well is without surface casing, a continuous cement plug shall be placed from at least 50 feet below the base of the lowest known aquifer or 300 feet depth, whichever is deeper, to the surface.

5. All intervals below and between plugs shall be filled with drilling mud, bentonite gel, or other appropriately weighted materials approved by the director.

C. *Plugging in cased hole.* When a cased hole or section of a cased hole is to be plugged or plugged back, it shall be sealed and filled as prescribed in this section.

1. All perforated intervals shall be either squeeze-cemented or otherwise isolated from the wellbore by suitable plugs placed across or immediately above the perforated interval. Cement plugs placed across perforations shall extend to at least 50 feet above the top perforations. A cement plug shall be placed to at least 50 feet above squeezed perforations. Cement plugs placed entirely above perforations shall be at least 100 feet in length. At least 20 feet of cement shall be placed on top of bridge plugs, cement retainers, or other tools left in the hole.

2. At each coal seam which is behind a properly installed and cemented coal-protection casing, a cement plug shall be placed from not less than [40 50] feet below the base of the coal to not less than [20 50] feet above the top of the coal. Whenever two or more coal seams are not widely separated, they may be treated as a single seam and plugged accordingly.

3. If casing is not to be pulled, and there is uncemented annulus behind the pipe, plugging shall be as follows:

a. Each oil, gas or water-bearing stratum present behind the pipe in an uncemented annulus must be isolated by perforating the casing at each zone and squeezing cement up into the zone, or circulating cement up the annulus such that a cement fill-up of not less than 100 feet is achieved. When squeezing

or circulating the annulus, a cement plug of at least 50 feet shall be placed inside the casing above the perforations.

b. If the well penetrates a minable coal-bearing section, and no coal-protection casing was used, and if surface (water-protection) casing is either absent or not properly placed and cemented to surface, the production casing shall be converted to a coal-protection string by perforating at least [40 50] feet below the base of the lowest coal stratum, and circulating cement in the annulus from that point to the surface.

c. At each coal seam in a minable coal-bearing section which is protected by a properly installed and cemented coal-protection string, a cement plug shall be placed in casing from not less than [40 50] feet below the base of the coal to not less than [20 50] feet above the top of the coal. If there is uncemented annulus between the inner casing and the coal-protection string, the casing shall be perforated to allow cement to be circulated over the prescribed interval, and a plug of equal length shall be placed inside the inner casing.

d. If a fresh water aquifer is exposed to the wellbore in an uncemented annulus, it shall be isolated by perforating the casing at least 100 feet below the aquifer and squeezing cement into the annulus or circulating it up the annulus so that a fill-up of not less than 100 feet is achieved. When squeezing or circulating cement, a cement plug of at least 100 feet shall be placed inside the casing above the perforation.

e. At a point no less than 50 feet below the shoe of surface (water-protection) string, the casing shall be perforated and cement circulated up the annulus to a minimum fill-up of 100 feet. A plug of equal length shall be placed inside the casing.

f. From a point not less than 50 feet below surface, a cement plug shall be installed which reaches the surface. If any uncemented annuli are present at the surface, the voids should be filled and sealed to the greatest extent possible by introducing cement from the surface.

g. All intervals below and between plugs shall be filled with drilling mud, bentonite gel, or other appropriately weighted materials approved by the director.

4. If casing is to be pulled, plugging shall be as follows:

a. All perforated intervals shall be isolated as described in subdivision C 1 of this section.

b. Casing stubs shall be isolated by placing a plug across or above the cut-off point. Cement plugs shall be at least 100 feet in length and shall be placed so as to have approximately equal lengths inside and above the remnant casing. Permanent bridge plugs may be

placed above the stub and shall be capped by at least 20 feet of cement.

D. *Plugging operations involving uncemented water-protection casing or coal-protection casing.*

1. *If the annulus of the largest casing present across a minable coal-bearing section is not cemented across that section, then one of the two procedures listed below must be followed:*

a. *The casing must be perforated at least [40 50] feet below the lowest coal seam, and cement circulated in the annulus to the surface (if water-protection casing is absent or not properly placed and cemented to surface), or to at least 100 feet above the highest coal (if the casing is to be partially pulled to facilitate plugging operations in the fresh water zone). Plugging shall proceed according to cased hole requirements; or*

b. *The casing shall be pulled from the well, and plugging shall proceed according to open hole requirements.*

2. *If the annulus of the largest casing present across the fresh-water-bearing section is not cemented across that section, then one of the two procedures listed below must be followed:*

a. *The casing shall be perforated below the lowest known fresh-water zone or at a minimum depth of 300 feet. Cement shall be circulated in the annulus to the surface. Plugging shall proceed according to [~~open~~ cased] hole requirements; or*

b. *The casing shall be pulled from the well, and a continuous cement plug shall be placed from below the base of the lowest known fresh-water aquifer exposed to the wellbore, or 300-foot depth, whichever is deeper, to the surface.*

E. *Unfillable cavities. When an unfillable cavity such as a cavern, mine void, blast stimulation zone or gob completion is encountered, the section shall be plugged as follows:*

1. *If the stratum with the unfillable cavities is the lowest gas or oil stratum in the well, a plug shall be placed at the nearest suitable point not less than 20 feet above the stratum. Cement plugs shall be at least 100 feet long, and at least 20 feet of cement shall be placed on top of bridge plugs.*

2. *If the stratum with unfillable cavities is above the lowest gas or oil stratum, a plug shall be placed below the stratum and shall extend to within 20 feet of its base. A plug shall also be placed above the stratum as described in subdivision E 1 of this section.*

4 VAC 25-150-440. Abandonment of a gas or oil well or corehole as a water well.

A permittee wishing to develop a gas or oil well or corehole as a water well shall submit an application for a

permit modification in accordance with 4 VAC 25-150-110 of ~~this chapter.~~

4 VAC 25-150-450. Identification, plugging and control of wells or coreholes in which radioactive source logging tools have been abandoned.

A. Permittees shall, by the quickest available means, notify the division of the loss of a radioactive source in a well or corehole.

B. No radioactive source shall be declared abandoned until all reasonable effort has been expended to retrieve the radioactive source tool.

C. A well or corehole in which a radioactive source has been abandoned shall be mechanically equipped and plugged so as to prevent either accidental or intentional mechanical disintegration of the radioactive source, as follows:

1. Sources abandoned in the bottom of the hole shall be covered with a 100-foot standard color cement plug, dyed with red iron oxide, and an approved deflection device shall be placed on top of the plug. The dye is to alert any reentry operator prior to encountering the source. From this point to the surface, the well or corehole shall be plugged as provided in ~~4 VAC 25-150-540, 4 VAC 25-150-640 or 4 VAC 25-150-710 of this chapter~~ 4 VAC 25-150-435.

2. Sources lost in locations other than in the bottom of the hole shall be abandoned ~~meeting in accordance with~~ the following standards:

a. If a well or corehole with the lost radioactive source will be abandoned and plugged, then a 100-foot standard color cement plug, dyed with red iron oxide, shall be placed above the abandoned source and an approved deflection device shall be placed on top of the plug. From this point to the surface, the well or corehole shall be plugged as provided in ~~4 VAC 25-150-540, 4 VAC 25-150-640 or 4 VAC 25-150-710 of this chapter~~ 4 VAC 25-150-435.

b. If a well or corehole is to be deviated or sidetracked around a lost radioactive source, then a 100-foot standard color ~~dye~~ cement plug, dyed with red iron oxide, shall be placed above the abandoned source, and an approved deflection device shall be placed on top of the plug.

c. Upon abandoning a well in which a radioactive source has been cemented in place behind a casing string above total depth, a 100-foot standard color cement plug, dyed with red iron oxide, shall be placed opposite the abandoned source and an approved deflection device placed on top of the plug, in addition to the plugging standards provided in ~~4 VAC 25-150-540, 4 VAC 25-150-640 or 4 VAC 25-150-710 of this chapter~~ 4 VAC 25-150-435.

3. If a permittee finds, after expending a reasonable effort, that ~~it is not possible, because of~~ hole conditions,

Final Regulations

make it impossible to abandon the source as prescribed in subdivision C 1 or C 2 of this section, then the permittee shall apply for a variance from the director for an alternate abandonment procedure.

D. Upon plugging and abandoning any well or corehole in which a radioactive source has been left in the hole, and after removing the wellhead equipment, a permanent plaque shall be attached to the top of the casing left in the hole in such a manner that reentry cannot be accomplished without disturbing the plaque. The plaque shall serve as a visual warning to any person reentering the hole that a radioactive source has been abandoned in place in the well. The plaque shall contain the trefoil radiation symbol with a radioactive warning and shall be constructed of a long-lasting material such as monel, stainless steel or brass.

E. The permittee shall erect a permanent marker as a visual warning to any person who may reenter the hole for any reason, showing that the hole contains a radioactive source. In addition to meeting the requirements of 4 VAC 25-150-460 ~~of this chapter~~, any marker for a hole containing a radioactive source shall bear the following information:

1. Surface location of the well;
2. Name of the lease;
3. Source of material abandoned in the well;
4. Total depth of the well;
5. Depth at which the source has been abandoned;
6. Date of the abandonment of the source;
7. Activity of the source;
8. Plug-back depth; and
9. A warning not to drill below the plug-back depth.

F. The information required by subsection E of this section shall be provided with the plugging affidavit submitted pursuant to 4 VAC 25-150-460 ~~of this chapter~~.

4 VAC 25-150-460. Identifying plugged wells and coreholes; plugging affidavit.

A. Abandoned wells and coreholes shall be permanently marked in a manner as follows:

1. The marker shall extend not less than 30 inches above the surface and enough below the surface to make the marker permanent.
2. The marker shall indicate the permittee's name, the well name, the permit number and date of plugging.

~~B. Each permittee plugging a well or corehole shall, prior to the well being plugged, submit a copy of the format to be used under subdivision A 2 of this section to the director.~~

~~C. In an area where there are no known underlying coal seams, B. A permittee may apply for a variance from the director to use alternate permanent markers. Such alternate markers shall provide sufficient information for locating the abandoned well or corehole. Provisions shall also be made~~

to provide for the physical detection of the abandoned well or corehole from the surface by magnetic or other means.

~~D. C. When any well or corehole has been plugged or replugged in accordance with 4 VAC 25-150-540, 4 VAC 25-150-640 or 4 VAC 25-150-710 of this chapter 4 VAC 25-150-435, two persons, experienced in plugging wells or coreholes, who participated in the plugging of a well or corehole, shall complete the plugging affidavit designated by the director, setting forth the time and manner in which the well or corehole was plugged and filled, and the permanent marker was placed.~~

~~E. D. One copy of the plugging affidavit shall be retained by the permittee, one shall be mailed to any coal owner or operator on the tract where the well or corehole is located, and one shall be filed with the division within 30 days after the day the well was plugged.~~

4 VAC 25-150-500. Application for a permit.

In addition to the requirements of 4 VAC 25-150-80 or 4 VAC 25-150-110 ~~of this chapter~~, every application for a permit or permit modification for a conventional gas or oil well or a Class II injection well shall contain:

1. The approximate depth to which the well is proposed to be drilled or deepened, or the actual depth ~~if to which~~ the well has been drilled;
2. ~~The location~~ *approximate depth* and thickness, *if applicable*, of all known coal seams, known groundwater-bearing strata, and other known gas or oil strata between the surface and the depth to which the well is proposed to be drilled;
3. If casing or tubing is proposed to be or has been set, a description of the entire casing program, including the size of each string of pipe, the starting point and depth to which each string is to be or has been set, and the extent to which each string is to be or has been cemented;
- ~~4. If the proposed work is to drill, redrill or deepen a well, a plan showing the proposed manner of plugging the well immediately after drilling if the proposed well work is unsuccessful so that the well must be plugged and abandoned;~~
- ~~5. 4. If the proposed work is for a Class II injection well, a copy of either the permit issued by, or the permit application filed with the Environmental Protection Agency under the Underground Injection Control Program; and the applicant shall reference the appropriate sections of the application filed with the Environmental Protection Agency whenever the Environmental Protection Agency governs an activity otherwise governed by this chapter; and.~~
- ~~6. If the proposed work is to plug or replug an existing well:
 - a. A statement of the time at which the work of plugging or replugging is proposed to be commenced;~~

~~b. A copy of all logs required to be run in accordance with this chapter and not previously filed with the division; and~~

~~c. A work order showing in detail the proposed manner of plugging or replugging the well.~~

5. *In addition to the requirements of 4 VAC 25-150-80 and 4 VAC 25-150-100, every application for a permit or permit modification for a conventional gas or oil well or a Class II injection well may contain, if the proposed work is to drill, redrill or deepen a well, a plan showing the proposed manner of plugging the well immediately after drilling if the proposed well work is unsuccessful.*

4 VAC 25-150-510. Plats.

A. In addition to the requirements of 4 VAC 25-150-90 of ~~this chapter~~, every plat for a conventional gas or oil well shall show:

1. The boundaries of any drilling unit established by the board around the subject well;
2. The boundaries and acreage of the tract on which the well is located or is to be located;
3. The boundaries and acreage of all other tracts within one-half of the distance specified in § 45.1-361.17 of the Code of Virginia or within one-half of the distance to the nearest well completed in the same pool, whichever is less, or within the boundaries of a drilling unit established by the board around the subject well;
4. Surface owners on the tract to be drilled and on all other tracts *within the unit* where the surface of the earth is to be disturbed;
5. All gas, oil or royalty owners on any tract located within one half of the distance specified in § 45.1-361.17 of the Code of Virginia or within one-half of the distance to the nearest well completed in the same pool, whichever is less, or within the boundaries of a drilling unit established by the board around the subject well;
6. Coal owners and mineral owners on the tract to be drilled and on all other tracts located within 500 feet of the subject well location;
7. Coal operators who have registered operations plans with the department for activities located on the tract to be drilled, or who have applied for or obtained a coal mine license, coal surface mine permit or a coal exploration notice or permit from the department with respect to all tracts within 500 feet of a proposed gas or oil well;
8. Any inhabited building, highway, railroad, stream, surface mine or mine opening within 500 feet of the proposed well; *and*
9. If the plat is for an enhanced oil recovery injection well, any other well within ~~2,640~~ 2,500 feet of the proposed or actual well location, which shall be presumed to embrace the entire area to be affected by an enhanced oil recovery injection well in the absence of

a board order establishing units in the target pool of a different size or configuration; ~~and.~~

~~10. Any other data the director may require.~~

B. If the well location is underlain by known coal seams, or if required by the director, the well plat shall locate the well and two permanent points or landmarks with reference to the mine coordinate system if one has been established for the area of the well location, and shall in any event show all other wells, surface mines and mine openings within the scope of the plat.

4 VAC 25-150-520. Setback restrictions.

No permit shall be issued for any well to be drilled closer than 200 feet from any inhabited building, *unless site conditions as approved by the director warrant the permission of a lesser distance, and there exists a lease or agreement between the operator and the owner of the inhabited building. A copy of the lease or agreement shall accompany the application for a permit.*

4 VAC 25-150-530. Casing requirements for conventional gas or oil wells.

A. Water-protection string.

1. Except as provided in subdivision A 3 5. of this section, the permittee shall set a water-protection string to a point at least 300 feet below the surface or 50 feet below the deepest known groundwater horizon, whichever is deeper, circulated and cemented in to the surface. If the cement does not return to the surface, every reasonable attempt shall be made to fill the annular space by introducing cement from the surface.

~~2. The water protection string and cement shall be designed to withstand, and shall be tested to, 300 psig surface pressure. The water protection string and cement shall be allowed to stand for 12 hours before drilling out from under the casing, unless the director approves a shorter period of time. The operator shall test or require the cementing company to test the cement mixing water for pH and temperature prior to mixing the cement and to record the results on the cementing ticket.~~

~~3. A coal protection string may also serve as a water protection string. After the cement is placed, the operator shall wait a minimum of eight hours and allow the cement to achieve a calculated compressive strength of 500 psi before drilling, unless the director approves a shorter period of time. The wait-on-cement (WOC) time shall be recorded within the records kept at the drilling rig while drilling is taking place.~~

4. *When requested by the director, the operator shall submit copies of cement tickets or other documents that indicate the above specifications have been followed.*

5. *A coal-protection string may also serve as a water-protection string.*

Final Regulations

B. Coal-protection strings.

1. When any well penetrates coal seams that have not been mined out, the permittee shall, except as provided in subdivisions B 2 and B 3 of this section, set a coal-protection string. The coal-protection string shall exclude all fluids, oil, gas and gas pressure ~~from the coal seam, except such fluid, oil, gas and gas pressure as may be that~~ which is naturally present in each coal seam. The coal-protection string shall also exclude all injected material or disposed waste from the coal ~~seams and the wellbore~~. The string of casing shall be set to a point at least ~~30~~ 50 feet below the lowest coal seam, or as provided in subdivision B 3 of this section, and shall be circulated and cemented ~~in~~ from that point to the surface ~~or to a point not less than 50 feet into the water-protection string or strings which are cemented to the surface~~.

2. For good cause shown, either before or after the permit is issued, when the procedure specified in subdivision B 1 is demonstrated by the permittee as not practical, the director may approve a casing program involving the cementing of a coal-protection string in multiple stages, or the cementing of two or more coal-protection strings, or the use of other alternative casing procedures. ~~The director may approve the program provided the director he is satisfied that the result will be operationally equivalent to compliance with the provisions of subdivision B 1 of this section for the purpose of permitting the subsequent safe mining through of the well or otherwise protecting the seam coal seams as required by this section.~~ In the use of multiple coal-protection strings, each string below the topmost string shall be cemented at least ~~30~~ 50 feet into the next higher string or strings that are cemented to the surface and be verified by a cement ~~and~~ top log.

3. Depth of coal-protection strings:

a. A coal-protection string shall be set to the top of the red shales in any area underlain by them unless, on a showing by the permittee in ~~his~~ the permit application, the director has approved the casing point of the coal-protection string at some depth less than the top of the red shales. In such event, the permittee shall conduct a gamma ray/density ~~compensated~~ log survey on an expanded scale to verify whether the well penetrates any coal seam in the uncased interval between the bottom of the coal-protection string as approved and the top of the red shales.

b. If an unanticipated coal seam ~~is~~ or seams are discovered in the uncased interval, the permittee shall report the discovery in writing to the director. The permittee shall cement the next string of casing, whether a part of the intermediate string or the production string, in the applicable manner provided in this section for coal-protection strings, from a point ~~30~~ at least 50 feet below the lowest coal seam so discovered ~~or to the top of the red shales, whichever~~

~~is shallower a point at least 50 feet above the highest coal seam so discovered.~~

c. The gamma ray/density ~~compensated~~ log survey shall be filed with the director at the same time the driller's log is filed under 4 VAC 25-150-360 ~~of this chapter~~.

d. When the director believes, after reviewing documentation submitted by the permittee, that the total drilling in any particular area has verified the deepest coal seam higher than the red shales, so that further gamma ray/density ~~compensated~~ logs on an expanded scale are superfluous for the area, he may waive the constructing of a coal-protection string or the conducting of such surveys deeper than 100 feet below the verified depth of the deepest coal seam.

C. Coal-protection strings of wells drilled prior to July 1, 1982. In the case of wells drilled prior to July 1, 1982, through coal seams without coal-protection strings substantially as prescribed in subsection B of this section, the permittee shall retain such coal-protection strings as were set. During the life of the well, the permittee shall, consistent with a plan approved by the director, keep the annular spaces between the various strings of casing adjacent to coal seams open to the extent possible, and the top ends of all such strings shall be provided with casing heads, or such other approved devices as will permit the free passage of gas or oil and prevent filling of the annular spaces with dirt or debris.

D. Producing from more than one stratum. The casing program for any well designed or completed to produce from more than one stratum shall be designed in accordance with the appropriate standard practices of the industry.

E. ~~Liner when well or corehole is drilled through mined-out coal seams~~ Casing through voids.

1. ~~When a well or corehole is drilled through a coal seam from which the coal has been removed, the hole shall be drilled at least thirty feet below the mined-out seam and of a size sufficient to permit the placing of a liner which shall start at a point not less than 20 feet beneath the horizon of the mined-out coal seam and extend to a point not less than 20 feet above it. The liner shall be firmly attached to the string of casing used at that point, and the space between the liner and the casing shall be filled with cement as they are lowered into the hole. Cement shall be placed in the bottom of the hole to a height of 10 feet above the bottom of the liner to form a sealed seat for both liner and casing. When a well is drilled through a void, the hole shall be drilled at least 30 feet below the void, the annular space shall be cemented from the base of the casing up to the void and to the surface from the top of the ~~the~~ void, or it shall be cemented at least 30 50 feet into the next higher string or strings of casing that are cemented to the surface and be verified by a cement ~~and~~ top log.~~

2. For good cause shown, the director may approve alternative casing procedures proposed by the

permittee, provided that the director is satisfied that the alternative casing procedures are operationally equivalent to the requirements imposed by subdivision E 1 of this section.

~~3. Except as provided in subdivision E 4 of this section, when a well or corehole is drilled through two or more coal seams from which the coal has been removed, and only one coal protection string is planned, the liner shall be started not less than 20 feet below the deepest mined-out coal seam and shall extend to a point not less than 20 feet above the shallowest mined-out coal seam. The annular space shall then be cemented as provided in subdivision E 1 of this section.~~

4. 3. For good cause shown, the director may: ~~a.~~ impose special requirements on the permittee to prevent communication between two or more mined-out coal seams; or voids.

~~b. Permit a casing program which calls for some or all mined-out coal seams to be equipped each with its own liner in the manner required by subdivision E 1 of this section.~~

F. A well penetrating a mine other than a coal mine. In the event that a permit is *permittee has* requested to drill a well in such a location that it would penetrate any active or abandoned mine other than a coal mine, the director shall establish *approve* the safety precautions to be followed by the permittee *prior to the commencement of activity*.

~~G. When a well is drilled through caverns.~~

~~When a well is drilled through one or more natural or artificial caverns to which the provisions of subsection E or F of this section do not apply, the permittee shall propose, and upon approval of the director, follow safety precautions for drilling through the caverns.~~

~~H. Unanticipated caverns or groundwater.~~

~~The permittee shall report to the director, by the quickest available means, when an unanticipated cavern or groundwater horizon is encountered during drilling. The permittee shall propose a permit amendment to take the necessary actions to protect the cavern or groundwater. The permittee shall not proceed with drilling until the director has approved the permit amendment.~~

G. *Reporting of lost circulation zones. The permittee shall report to the director as soon as possible when an unanticipated void or groundwater horizon is encountered that results in lost circulation during drilling. The permittee shall take every necessary action to protect the lost circulation zone.*

4 VAC 25-150-540. Plugging conventional wells. (Repealed.)

~~A. Plugging a well that does not penetrate a coal seam.~~

~~1. When a well does not penetrate a coal seam, it shall be plugged and filled as prescribed in this subsection. Details of the plugging must be shown in an application~~

~~submitted by the permittee to the director. The plugging shall, subject to the exceptions in subdivision A 3 of this section, be as follows:~~

~~a. From the bottom of the well to a point 20 feet above the top of its lowest oil, gas or water-bearing stratum, the well shall either:~~

~~(1) Be filled with mud, clay or other impermeable material, or~~

~~(2) Have a permanent bridge anchored 30 feet below its lowest oil, gas or water-bearing stratum, and therefrom be filled with mud, clay or other impermeable material;~~

~~b. From a point 20 feet above the top of its lowest oil, gas or water-bearing stratum, a plug of cement or other suitable material shall be placed which will completely seal the hole;~~

~~c. Between this sealing plug and a point 20 feet above the next higher oil, gas or water-bearing stratum, if any, the hole shall be filled or bridged and filled as first provided, on top of which another plug of cement or other suitable material shall be placed as provided in subdivision A 1 b of this section;~~

~~d. If applicable due to the presence of additional oil, gas or water-bearing strata, the hole shall be filled and plugged as provided in subdivision A 1 c of this section through the uppermost plug of cement or other suitable material 20 feet above the highest such stratum;~~

~~e. Approximately 10 feet below the bottom of the largest casing left in the well, a cement plug shall be placed;~~

~~f. From the cement plug at the bottom of the largest casing left in the well to a point 50 feet below the surface, the well shall be filled with mud, clay or other impermeable material;~~

~~g. From the point 50 feet below the surface to the surface, a plug of cement shall be installed.~~

~~2. Notwithstanding the prescription in subdivision A 1 of this section, whenever two or more gas or oil strata are not widely separated and are free from water, they may be grouped and treated as a single stratum, and the filling and plugging prescribed in subdivision A 1 of this section may be performed as though the group of gas or oil strata were a single stratum.~~

~~3. If any gas or oil stratum in the well to be plugged has been stimulated by blasting, then the well may be filled and plugged as prescribed in subdivision A 1 of this section as long as the blasting did not result in cavities which cannot readily be filled. However, if there are blasted-out cavities in any gas or oil stratum which cannot be filled as prescribed in subdivision A 1 of this section, then they shall be filled as prescribed in subdivisions A 3 a and A 3 b of this section, and the~~

Final Regulations

remainder of the hole shall be plugged and filled as prescribed in subdivision A 1 of this section.

a. ~~If the stratum with unfillable cavities is the lowest gas or oil stratum in the well, one of the two plugging alternatives in subdivision A 3 a (1) or A 3 a (2) of this section shall be employed in the following order of preference:~~

~~(1) If reasonably possible, from a point not less than 20 feet below the stratum with unfillable cavities to a point not less than 20 feet above it, a liner shall be placed and compactly filled with cement, mud, clay or other impermeable sealing material; or~~

~~(2) Alternatively, if need be, at the nearest suitable point not less than 20 feet above the stratum, a plug of cement or other suitable material shall be placed which will completely seal the hole.~~

b. ~~If the stratum with unfillable cavities is above the lowest gas or oil stratum, then one of the two plugging alternatives in subdivisions A 3 b (1) or A 3 b (2) of this section shall be employed in the following order of preference:~~

~~(1) If reasonably possible, from a point not less than 20 feet below the shot stratum with unfillable cavities to a point not less than 20 feet above it, a liner shall be placed and compactly filled with cement, mud, clay or other impermeable sealing material; or~~

~~(2) Alternatively, if need be, a plug of cement or other suitable material shall be placed not less than 20 feet below the stratum which will completely seal the hole from the lower strata, and a second plug of cement or other suitable material shall be placed not less than 20 feet above the stratum which will completely seal the hole at that point.~~

~~B. Plugging a well penetrating a coal seam without a coal protection string.~~

~~1. When a well penetrates a coal seam and does not have a coal protection string installed in the manner required by 4 VAC 25-150-530 of this chapter, it shall be plugged and filled as prescribed in this subsection. Details of the plugging must be shown in an application submitted by the permittee to the director. The plugging shall be as follows:~~

~~a. From the bottom of the well to a point not less than 40 feet below the lowest coal seam, the well shall be plugged and filled as prescribed in subsection A of this section;~~

~~b. At the point not less than 40 feet below the lowest coal seam, a cement plug shall be securely placed in the well;~~

~~c. From the cement plug to a point 20 feet above the lowest coal seam, the well shall be filled with cement;~~

~~d. From the point not less than 20 feet above the lowest coal seam to a point 40 feet below the next~~

~~higher coal seam, if any, the well shall be filled with mud, clay or other impermeable material;~~

~~e. If applicable due to additional coal seams, the hole shall be filled and plugged as provided in the second, third, and fourth steps through the highest coal seam;~~

~~f. From a point 20 feet above the highest coal seam to a point 50 feet below the surface, filling and plugging of the well shall continue in the manner provided in subsection A of this section; and~~

~~g. From the point 50 feet below the surface to the surface, a plug of cement shall be installed.~~

~~C. Plugging a well with coal protection strings installed.~~

~~1. When a well penetrates a coal seam through which a coal protection string has been installed in the manner required by 4 VAC 25-150-530 of this chapter, the well shall be plugged and filled as prescribed in this subsection to facilitate the safe mining through of the well at a later date. Details of the plugging must be shown in an application submitted by the permittee to the director.~~

~~a. From the bottom of the well to a point approximately 100 feet below the lowest coal seam, the well shall be plugged and filled as prescribed in subsection A of this section, except that expanding cement shall be used instead of regular hydraulic cement;~~

~~b. At the point 100 feet below the lowest coal seam, a 100-foot plug of expanding cement shall be placed in the well so that the top of the plug is located at a point just below the coal protection string or the lowest coal seam;~~

~~c. After the plug has been securely placed in the well as provided in subdivision C 1 b of this section, the coal protection string, or innermost coal protection string if more than one coal protection string is set from that point to the surface, shall be emptied of liquid from the surface to a point 100 feet below the lowest coal seam or to the bottom of the coal protection string, whichever is closer to the surface; and~~

~~d. A vent or other device approved by the director shall be installed on the top of the coal protection string, or innermost coal protection string, a distance of not less than thirty inches above ground level in a manner that will exclude liquids and solids from the well and that will permit ready access when required to the full internal diameter of the coal protection string, or innermost coal protection string, of the well.~~

~~D. Special plugging at the coal owner or operator's request.~~

~~1. When a well penetrates a coal seam and does not have a coal protection string installed in the manner required by 4 VAC 25-150-530 or 4 VAC 25-150-610 of this chapter, in order to facilitate the safe mining through~~

~~of the well at a later time, the director may, upon application by the permittee, approve a variance to the plugging method provided in subsection B of this section. A permittee and coal owner or operator may jointly submit a request for a variance for special plugging as part of the permit modification application. The request for a variance shall include the permit number, well name and proposed plugging program. The request shall be filed with the director prior to the scheduled plugging of the well.~~

~~2. If under particular circumstances a specific method of plugging is required to obtain the approval of another governmental agency for the safe mining through of a well, then the director may approve a variance for the different method of plugging if he finds that:~~

- ~~a. The well will be adequately plugged to meet the purpose of the Act;~~
- ~~b. The well will be adequately plugged for the purpose of safely mining through; and~~
- ~~c. No gas, oil or other fluids can migrate into the mine workings.~~

~~E. Replugging a previously plugged well.~~

~~Any person may file an application with the director to replug a previously plugged well in any manner permissible under the provisions of this section to facilitate the safe mining through of the well at a later date. The application shall be treated in all respects like any other application for a permit under § 45.1-361.29 of the Code of Virginia.~~

4 VAC 25-150-560. Application for a permit.

In addition to the requirements of 4 VAC 25-150-80 or 4 VAC 25-150-110 of this chapter, every application for a permit or permit modification for a coalbed methane gas well shall contain:

1. An identification of the category of owner or operator, as listed in § 45.1-361.30 A of the Code of Virginia, that each person notified of the application belongs to;
2. The signed consent required in § 45.1-361.29 of the Code of Virginia;
3. Proof of conformance with any mine development plan in the vicinity of the proposed coalbed methane gas well, when the Virginia Gas and Oil Board has ordered such conformance;
4. The approximate depth to which the well is proposed to be drilled or deepened, or the actual depth if the well has been drilled;
5. The ~~location~~ *approximate depth* and thickness, *if applicable*, of all known coal seams, known groundwater-bearing strata, and other known gas or oil strata between the surface and the depth to which the well is proposed to be drilled;
6. If casing or tubing is proposed to be or has been set, a description of the entire casing program, including the

size of each string of pipe, the starting point and depth to which each string is to be or has been set, and the extent to which each string is to be or has been cemented together with any request for a variance under 4 VAC 25-150-580 of this chapter;

7. An explanation of the procedures to be followed to protect the safety of persons working in an underground coal mine for any coalbed methane gas well to be drilled within 200 feet of or into any area of an active underground coal mine; which shall, at a minimum, require that notice of such drilling be given by the permittee to the mine operator and the Chief at least two working days prior to drilling within 200 feet of or into the mine;

~~8. If the proposed work is to drill, redrill or deepen a coalbed methane gas well, a plan showing the proposed manner of plugging the well immediately after drilling if the proposed well work is unsuccessful so that the well must be plugged and abandoned; and~~

~~9. if the proposed work is to plug or replug an existing well:~~

- ~~a. A statement of the time at which the work of plugging or replugging is proposed to be commenced;~~
- ~~b. A copy of all logs required to be run in accordance with this chapter, not previously filed with the division; and~~
- ~~c. A work order showing in detail the proposed manner of plugging or replugging the well.~~

8. If the proposed work is for a Class II injection well, a copy of the Environmental Protection Agency permit, or a copy of the application filed with the Environmental Protection Agency under the Underground Injection Control Program; and

9. In addition to the requirements of 4 VAC 25-150-80 or 4 VAC 25-150-100, every application for a permit or permit modification for a coalbed methane well or a Class II injection well may contain, if the proposed work is to drill, redrill or deepen a well, a plan showing the proposed manner of plugging the well immediately after drilling if the proposed well work is unsuccessful so that the well must be plugged and abandoned.

4 VAC 25-150-570. Simultaneous applications for permits for a coalbed methane gas well and a vertical ventilation hole. (Repealed.)

~~A. Applicants who intend to operate a coalbed methane gas well for a period of time and then later convert that well to operation as a vertical ventilation hole may submit simultaneous applications for both permits prior to commencement of any activity on the proposed well site. This application process may also be used by applicants who plan to convert from a coalbed methane gas well to a vertical ventilation hole while mining through, and then later operate the hole as a gob well. Applications made under this section for coalbed methane gas wells or gob wells shall be~~

Final Regulations

~~in accordance with the requirements of the Act and of this chapter. Applications made under this section for vertical ventilation holes shall be in accordance with the requirements of Parts II and III of the Regulations Governing Vertical Ventilation Holes and Mining Near Gas and Oil Wells, 4 VAC 25-100-10 et seq.~~

~~B. Applications submitted simultaneously under this section shall contain, in addition to the information required for each type of permit when submitted separately, a detailed description of the nature of the activities to be conducted from the time activity commences on the site until final plugging of the holes takes place. The description shall include the estimated date for converting the well.~~

~~C. Applicants who submit simultaneous applications under this section shall fulfill the notice requirements for each type of permit at the time of the application. The notice shall inform all parties with standing to object to any permit of their right to object, and state the prescribed time limits for objections. Any person who objects to applications for permits filed under this section shall comply with the applicable requirements for filing objections to the type of permit being requested.~~

~~D. If there are timely objections made to permits proposed in simultaneously submitted applications, then the chief and the director shall determine who has authority to hear the objections and schedule a hearing according to applicable provisions of the laws and regulations pertaining to the permits for which objections are made. If objections are filed against more than one type of permit, then the objections may be heard jointly at a single hearing.~~

~~E. The director shall issue a permit for a coalbed methane gas well when a simultaneous application has been submitted for a vertical ventilation hole only after the chief has indicated to the director that the vertical ventilation hole application meets the requirements for a permit from the chief.~~

~~F. The operators of a coalbed methane gas well and a vertical ventilation hole so permitted shall jointly notify the chief and the director in writing at least two working days prior to commencement of activity on conversion of a coalbed methane well to a vertical ventilation hole or conversion of a vertical ventilation hole to a gob well.~~

4 VAC 25-150-580. Variance request to convert a vertical ventilation hole to a coalbed methane gas well.

A. An applicant may request a variance to the casing standards in 4 VAC 25-150-610 ~~of this chapter~~ when the applicant desires to convert a vertical ventilation hole drilled prior to September 25, 1991, to a coalbed methane gas well. All other standards for coalbed methane gas wells shall be met. The variance request must be included in the request for a permit, and shall address the following subjects:

1. Method of wellbore completion, whether cased, open or cased/open hole;
2. Coal seams to be left uncased;

3. Mining activity currently being conducted within 750 feet of the location;

4. Depth of the water-protection string *and information on how the casing was cemented*; *and*

5. In the case of a coalbed methane gas well drilled through a coal seam from which the coal has been removed, the protection provided to prevent the escape of any gases into the mined out seam; *and*

~~6. The pressure tests to document the integrity of the casing program. The production casing shall be tested to 300 psig surface pressure or the highest pressure anticipated to be placed on the casing, whichever is greater. If after 30 minutes, the pressure has dropped by 10% or more of the test pressure, corrective action shall be taken to ensure that the casing is so set and cemented that it will hold at least 90% of the test pressure for 30 minutes or more.~~

B. No variance to the casing standards in 4 VAC 25-150-610 ~~of this chapter~~ shall be allowed for the conversion of any vertical ventilation hole drilled on or after September 25, 1991, to a coalbed methane gas well.

4 VAC 25-150-590. Plats.

A. In addition to the requirements of 4 VAC 25-150-90 ~~of this chapter~~, every plat for a coalbed methane gas well shall show:

1. Boundaries and acreage of any drilling unit established by the board around the subject well;

2. Boundaries and acreage of the tract on which the well is located or is to be located;

3. Boundaries and acreage of all other tracts within one-half of the distance specified in § 45.1-361.17 of the Code of Virginia or within one-half of the distance to the nearest well completed in the same pool, whichever is less, or within the boundaries of a drilling unit established by the board around the subject well;

4. Surface owners on the tract to be drilled and on all other tracts *within the unit* where the surface of the earth is to be disturbed;

5. All gas, oil or royalty owners on any tract located within one-half of the distance specified in § 45.1-361.17 of the Code of Virginia or within one-half of the distance to the nearest well completed in the same pool, whichever is less, or within the boundaries of a drilling unit established by the board around the subject well;

6. Coal owners and mineral owners on the tract to be drilled and on all other tracts located within 750 feet of the subject well location;

7. Coal operators who have registered operations plans with the department for activities located on the tract to be drilled, or who have applied for or obtained a coal mine license, coal surface mine permit or a coal exploration notice or permit from the department with respect to all tracts within 750 feet of a proposed gas or oil well; *and*

8. Any inhabited building, highway, railroad, stream, surface mine or mine opening within ~~750~~ 500 feet of the proposed well; ~~and~~.

~~9. Any other data the director may require.~~

B. The well plat shall locate the well and two permanent points or landmarks with reference to the mine coordinate system if one has been established for the area of the well location, and shall show all other wells, ~~surface mines and mine openings~~ within the scope of the plat.

4 VAC 25-150-600. Setback restrictions.

No permit shall be issued for any well to be drilled closer than 200 feet from any inhabited building, *unless site conditions as approved by the director warrant the permission of a lesser distance, and there exists a lease or agreement between the operator and the owner of the inhabited building. A copy of the lease or agreement shall accompany the application for a permit.*

4 VAC 25-150-610. Casing requirements for coalbed methane gas wells.

~~A. The following minimum casing requirements shall be met for casing coalbed methane gas wells.~~

~~4.~~ A. Water protection string.

~~a. Unless otherwise granted in a variance from the director, all wells drilled in search of coalbed methane gas shall have~~ 1. *Except as provided in subdivision A 5 of this section, the permittee shall set a water protection string set to a point at least 300 feet below the surface or 50 feet below the lowest groundwater horizon, whichever is deeper, circulated and cemented in to the surface. If cement does not return to the surface, every reasonable effort shall be made to fill the annular space by introducing cement from the surface.*

~~b. If cement does not return to the surface, every reasonable attempt shall be made to fill the annular space by introducing cement from the surface. The water protection string and cement shall be designed to withstand, and shall be tested to, 300 psig surface pressure. The water protection string and cement shall be allowed to stand for 12 hours before drilling out from under the casing, unless the director approves a shorter period of time.~~

2. *The operator shall test or require the cementing company to test the cement mixing water for pH and temperature prior to mixing the cement and to record the results on the cementing ticket.*

3. *After the cement is placed, the operator shall wait a minimum of eight hours and allow the cement to achieve a calculated compressive strength of 500 psi before drilling, unless the director approves a shorter period of time. The wait-on-cement (WOC) time shall be recorded within the records kept at the drilling rig while drilling is taking place.*

4. *When requested by the director, the operator shall submit copies of cement tickets or other documents that indicate the above specifications have been followed.*

~~e.~~ 5. A coal-protection string may also serve as a water protection string.

B. Coal ~~protection~~ production strings.

~~Any coal seams that will not be produced from and that have not been mined out shall be cased and cemented in accordance with 4 VAC 25-150-530 B of this chapter.~~

1. *When any well penetrates coal seams that have not been mined out, the permittee shall, except as provided in subdivisions B 2 and B 3 of this section, set a coal-protection string. The coal-protection string shall exclude all fluids, oil, gas, and gas pressure, except that which is naturally present in each coal seam. The coal-protection string shall also exclude all injected material or disposed waste from the coal seams or the wellbore. The string of casing shall be set to a point at least 50 feet below the lowest coal seam, or as provided in subdivision B 3 of this section, and shall be circulated and cemented from that point to the surface, or to a point not less than 50 feet into the water-protection string or strings which are cemented to the surface.*

2. *For good cause shown, either before or after the permit is issued, when the procedure specified in subdivision B 1 is demonstrated by the permittee as not practical, the director may approve a casing program involving:*

a. *The cementing of a coal-protection string in multiple stages;*

b. *The cementing of two or more coal-protection strings; or*

c. *The use of other alternative casing procedures.*

3. *The director may approve the program, provided he is satisfied that the result will be operationally equivalent to compliance with the provisions of subdivision B 1 of this section for the purpose of permitting the subsequent safe mining through the well or otherwise protecting the coal seams as required by this section. In the use of multiple coal-protection strings, each string below the topmost string shall be cemented at least 50 feet into the next higher string or strings that are cemented to the surface and be verified by a cement top log.*

4. *Depth of coal-protection strings.*

a. *A coal-protection string shall be set to the top of the red shales in any area underlain by them unless, on a showing by the permittee in the permit application, the director has approved the casing point of the coal-protection string at some depth less than the top of the red shales. In such event, the permittee shall conduct a gamma-ray/density log survey on an expanded scale to verify whether the well penetrates any coal seam in the uncased interval between the*

Final Regulations

bottom the coal-protection string as approved and the top of the red shales.

b. If an unanticipated coal seam or seams are discovered in the uncased interval, the permittee shall report the discovery in writing to the director. The permittee shall cement the next string of casing, whether a part of the intermediate string or the production string, in the applicable manner provided in this section for coal-protection strings, from a point at least 50 feet below the lowest coal seam so discovered to a point at least 50 feet above the highest coal seam so discovered.

c. The gamma-ray/density log survey shall be filed with the director at the same time the driller's log is filed under 4 VAC 25-150-360.

d. When the director believes, after reviewing documentation submitted by the permittee, that the total drilling in any particular area has verified the deepest coal seam higher than the red shales, so that further gamma-ray/density logs on an expanded scale are superfluous for the area, he may waive the constructing of a coal-protection string or the conducting of such surveys deeper than 100 feet below the verified depth of the deepest coal seam.

C. ~~When a well is drilled through a mined-out coal seam, a liner shall be installed in accordance with 4 VAC 25-150-530 E of this chapter. Coal-protection strings of wells drilled prior to July 1, 1982. In the case of wells drilled prior to July 1, 1982, through coal seams without coal-protection strings as prescribed in subsection B of this section, the permittee shall retain such coal-protection strings as were set. During the life of the well, the permittee shall, consistent with a plan approved by the director, keep the annular spaces between the various strings of casing adjacent to coal seams open to the extent possible, and the top ends of all such strings shall be provided with casing heads, or such other approved devices as will permit the free passage of gas or oil and prevent filling of the annular spaces with dirt or debris.~~

D. ~~When a well is drilled through any active or abandoned mine other than a coal mine, the well shall be developed in accordance with the requirements of 4 VAC 25-150-530 F of this chapter. Producing from more than one stratum. The casing program for any well designed or completed to produce from more than one stratum shall be designed in accordance with the appropriate standard practices of the industry.~~

E. ~~When a well is drilled through any natural or artificial caverns to which the provisions of subsection C or D of this section do not apply, the well shall be developed in accordance with the requirements of 4 VAC 25-150-530 G of this chapter. Casing through voids.~~

1. ~~When a well is drilled through a void, the hole shall be drilled at least 30 feet below the void. The annular space shall be cemented from the base of the casing up to the void, and to the surface from the top of the void;~~

~~or it shall be cemented at least 50 feet into the next higher string or strings of casing that are cemented to the surface, and shall be verified by a cement top log.~~

2. ~~For good cause shown, the director may approve alternate casing procedures proposed by the permittee, provided that the director is satisfied that the alternative casing procedures are operationally equivalent to the requirements imposed by subdivision E 1 of this section.~~

3. ~~For good cause shown, the director may impose special requirements on the permittee to prevent communication between two or more voids.~~

F. ~~Unanticipated caverns or groundwater. A well penetrating a mine other than a coal mine.~~

~~The permittee shall report to the director, by the quickest available means, when an unanticipated cavern or groundwater horizon is encountered during drilling. The permittee shall propose a permit amendment to take the necessary actions to protect the cavern or groundwater. The permittee shall not proceed with drilling until the Director has approved the permit amendment. In the event that a permittee has requested to drill a well in such a location that it would penetrate any active mine other than a coal mine, the director shall approve the safety precautions to be followed by the permittee prior to the commencement of activity.~~

G. Production casing.

1. Unless otherwise granted in a variance from the director:

a. For coalbed methane gas wells with cased completions and cased/open hole completions, production casing shall be set and cemented in place with a calculated cement volume to fill the annular space from the bottom of the casing to the surface or to a point not less than 30 50 feet into the lowest coal-protection or water-protection string or strings which are cemented to the surface.

b. For coalbed methane gas wells with open hole completions, the base of the casing shall be set to not more than 100 feet above the uppermost coalbed which is to be completed open hole. The casing shall be cemented to fill the calculated annular space from the bottom of the casing to the surface or to a point not less than 30 50 feet into the lowest coal-protection or water-protection string or strings which are cemented to the surface.

2. ~~Before drilling out the production casing, the casing shall be tested to 300 psig surface pressure or the highest pressure anticipated to be placed on the casing, whichever is greater. If after 30 minutes, the pressure has dropped by 10% or more of the test pressure, corrective action shall be taken to ensure that the casing is so set and cemented that it will hold 90% of the the test pressure for 30 minutes or more. All test results shall be posted at the well site and shall be reported with the completion report pursuant to 4 VAC 25-150-360 of this chapter.~~

3. 2. A coal-protection string may also serve as production casing.

H. *Reporting of lost circulation zones.* The permittee shall report to the director as soon as possible when an unanticipated void or groundwater horizon is encountered that results in lost circulation during drilling. The permittee shall take every necessary action to protect the lost circulation zone.

4 VAC 25-150-640. ~~Plugging coalbed methane gas wells. (Repealed.)~~

A. ~~In addition to the provisions of 4 VAC 25-150-540 of this chapter, coalbed methane gas wells may be plugged as follows:~~

1. ~~For open hole, cased hole, or cased/open hole completions, plugging shall be:~~

a. ~~From the bottom of the well to a point not less than 40 feet below the lowest coal seam, or from the obtainable bottom, whichever is shallower, the well shall either (i) be filled with mud, clay, or other impermeable material, or (ii) have a permanent bridge anchored 40 feet below its lowest coal seam;~~

b. ~~From the point 40 feet below the lowest coal seam to a point 20 feet above the lowest coal seam, the well shall be filled with cement;~~

c. ~~From the point not less than 20 feet above the lowest coal seam to a point 40 feet below the next higher coal seam, if any, the well shall be filled with mud, clay, or other impermeable material;~~

d. ~~If applicable due to additional completed zones or mineable coal seams, the hole shall be filled and plugged as provided in subdivisions A 1 b and A 1 c of this section through the shallowest coal seam;~~

e. ~~From a point 20 feet above the shallowest coal seam to a point 50 feet below the surface, the well shall be filled with mud, clay or other impermeable material; and,~~

f. ~~From a point 50 feet below the surface to the surface, a plug of cement shall be installed.~~

2. ~~For completions in the gob, plugging shall be:~~

a. ~~A permanent bridge plug shall be set at the base of the deepest casing string left in the well;~~

b. ~~A 100-foot cement plug shall be set on top of the permanent bridge;~~

c. ~~If applicable due to additional completed zones or mineable coal seams, the hole shall be filled and plugged as provided in subdivisions A 1 b and A 1 c of this section through the shallowest coal seam;~~

d. ~~From the point 20 feet above the shallowest coal seam to the point 50 feet below the surface, the well shall be filled with mud, clay or other impermeable material; and~~

e. ~~From the point 50 feet below the surface to the surface, a plug of cement shall be installed.~~

B. ~~These provisions shall not be construed to impair or abridge the requirements of the Federal Mine Safety and Health Administration or the Department of Mines, Minerals and Energy, Division of Mines on coal operators for mining near or through a coalbed methane gas well.~~

4 VAC 25-150-650. Abandonment through conversion to a vertical ventilation hole.

A. A permittee wishing to abandon a coalbed methane gas well as a vertical ventilation hole shall submit an application for a permit modification for such abandonment unless conversion to a vertical ventilation hole was approved in a permit issued in accordance with 4 VAC 25-150-570 of this part which includes approval from the chief of the Division of Mines.

B. No application under this section shall be approved by the director until the application for a vertical ventilation hole has been approved by the chief.

4 VAC 25-150-660. Applicability.

Part IV (4 VAC 25-150-660 et seq.) of this chapter sets forth requirements unique to ground-disturbing geophysical exploration. ~~Permittees must comply with both the standards of general applicability in Part I of this chapter and the standards for ground-disturbing geophysical exploration in this part.~~

4 VAC 25-150-670. Application for a permit.

A. *In accordance with 4 VAC 25-150-80 and 4 VAC 25-150-110,* a permit shall be required for a ~~corehole or other~~ ground-disturbing geophysical exploration.

B. In addition to the requirements of 4 VAC 25-150-80 or 4 VAC 25-150-110, every application for a *corehole* permit or permit modification under this part shall contain:

1. The approximate depth to which the corehole is proposed to be drilled or deepened, or the actual depth if the corehole has been drilled;

2. The ~~location~~ *approximate depth* and thickness, *if applicable*, of all known coal seams, known groundwater bearing strata, and other known gas or oil strata between the surface and the depth to which the corehole is proposed to be drilled;

3. If casing or ~~tubing~~ is proposed to be set, the entire casing program, including the *size diameter* of each string of *pipe casing*, the starting point and depth to which each string is to be set, *whether or not the casing is to remain in the hole after the completion of drilling*, and the extent to which each string is to be cemented, *if applicable*;

4. If a corehole is proposed to be drilled or deepened, A plan to plug the corehole shall be included, which shall contain: *shows the proposed manner of plugging or replugging the corehole.*

Final Regulations

- ~~a. A statement of the time at which the work of plugging or replugging is proposed to be commenced;~~
- ~~b. A copy of all logs required to be run in accordance with this chapter not previously filed with the division; and~~
- ~~c. A plan showing the proposed manner of plugging or replugging the corehole.~~

4 VAC 25-150-680. Plats.

A. In addition to the requirements of 4 VAC 25-150-90 of ~~this chapter~~, every plat for a corehole shall show:

- 1. The boundaries of the tract on which the corehole is located or is to be located;
- 2. Surface owners on the tract to be drilled and *surface owners* on ~~all other~~ *the* tracts where the surface is to be disturbed;
- 3. Coal owners and mineral owners on the tract to be drilled;
- 4. Coal operators who have registered operations plans with the department for activities located on the tract to be drilled; *and*
- 5. Any inhabited building, highway, railroad, stream, surface mine or mine opening within 500 feet of the proposed corehole; *and*.
- 6. ~~Any other data the director may require.~~

B. If the corehole location is underlain by known coal seams, the plat shall locate the corehole and two permanent points or landmarks with reference to the mine coordinate system if one has been established for the area of the corehole location, and shall in any event show all other wells, surface mines and mine openings within the scope of the plat.

4 VAC 25-150-690. Operations plans.

In addition to the requirements of 4 VAC 25-150-100 of ~~this chapter~~, every operational plan for a corehole shall describe the measures to be followed to protect water quality during the ~~geophysical operations~~ *drilling, and the measures to be followed to protect any voids encountered during drilling.*

4 VAC 25-150-700. Setback restrictions.

No permit shall be issued for any corehole to be drilled closer than 200 feet from inhabited building, *unless site conditions as approved by the director warrant the permission of a lesser distance, and there exists a lease or agreement between the operator and the owner of the inhabited building. A copy of the lease or agreement shall accompany the application for a permit.*

4 VAC 25-150-710. Plugging coreholes. (Repealed.)

~~A. A plugging plan shall be submitted with the application for a permit for a corehole.~~

~~B. A corehole shall be plugged and filled as follows:~~

~~1. From the bottom of the corehole to a point not less than 40 feet below the lowest coal, oil, gas, or water-bearing stratum, the hole shall be filled with mud, clay, or other impermeable material.~~

~~2. From this point to a point 20 feet above the lowest coal, oil, gas, or water-bearing stratum, the hole shall be filled with cement.~~

~~3. From the point not less than 20 feet above the lowest coal, oil, gas, or water-bearing stratum to a point 40 feet below the next higher coal, oil, gas, or water-bearing stratum, the hole shall be filled with mud, clay, or other impermeable material.~~

~~4. If applicable due to additional coal, oil, gas, or water-bearing stratum, the hole shall be filled and plugged as provided in the first, second, and third steps through the highest coal, oil, gas, or water-bearing stratum.~~

~~5. From a point 20 feet above the highest coal, oil, gas, or water-bearing stratum to a point 50 feet below the surface, or in areas with unconsolidated material deeper than 50 feet below the surface, to a point five feet below the top of consolidated rock, the hole shall be filled with mud, clay, or other impermeable material.~~

~~6. From the point 50 feet below the surface or the point five feet below the top of consolidated rock to the surface, whichever is deeper, a plug of cement shall be set.~~

~~C. Whenever two or more coal, oil, or gas strata are not sufficiently separated and are free from water, they may be grouped and treated as a single stratum, and the filling and plugging prescribed in subsection B of this section may be performed as though the group were a single stratum.~~

~~D. For good cause shown, or when a corehole has a two inch or smaller diameter, a permittee may request a variance for alternate plugging procedures. The director shall approve the alternate procedures when he is satisfied the alternate procedures are as effective as the requirements of subsections B and C of this section.~~

4 VAC 25-150-711. Voids and lost circular zones.

A. *Casing through voids.*

1. When a corehole is drilled through a void, the hole shall be drilled at least 30 feet below the void. The annular space shall be cemented from the base of the casing up to the void, and to the surface from the top of the void; or it shall be cemented at least 50 feet into the next higher string or strings of casing that are cemented to the surface, and be verified by a cement top log.

2. For good cause shown, the director may approve alternate casing procedures proposed by the permittee, provided that the director is satisfied that the alternative casing procedures are operationally equivalent to the requirements imposed by this section.

3. For good cause shown, the director may impose special requirements on the permittee to prevent communication between two or more voids.

B. Reporting of lost circulation zones. The permittee shall report to the director as soon as possible when an unanticipated void or groundwater horizon is encountered that results in lost circulation during drilling. The permittee shall take every necessary action to protect the lost circulation zone.

4 VAC 25-150-720. Applicability.

A. Part V (4 VAC 25-150-720 et seq.) of this chapter sets forth requirements unique to gathering pipelines. Permittees must comply with the standards for gathering pipelines in this part and the following standards in Part I:

1. All of Article 1, "General Information," except 4 VAC 25-150-50, "Gas or Oil in Holes Not Permitted as a Gas or Oil Well";
2. All of Article 2, "Permitting," except 4 VAC 25-150-90, "Plats";
3. All of the sections in Article 3, "Enforcement";
4. 4 VAC 25-150-220, "Annual Reports" of Article 4, "Reporting";
5. 4 VAC 25-150-230, 4 VAC 25-150-240, 4 VAC 25-150-250, 4 VAC 25-150-260, 4 VAC 25-150-270, 4 VAC 25-150-310, 4 VAC 25-150-350, 4 VAC 25-150-380, 4 VAC 25-150-410, 4 VAC 25-150-420, 4 VAC 25-150-430 of Article 5, "Technical Standards"; and
6. 4 VAC 25-150-470, "Release of Bond" of Article 6-, "Plugging and Abandonment."

B. A permit shall be required for installation and operation of every gathering pipeline and associated structures for the movement of gas or oil production from the wellhead to a previously permitted gathering line, a transmission or other line regulated by the Federal Energy Regulatory Commission United States Department of Transportation or the State Corporation Commission, to the first point of sale, or for oil, to a temporary storage facility for future transportation by a method other than a gathering pipeline.

C. Each gathering pipeline or gathering pipeline system may be permitted separately from gas or oil wells or may be included in the permit for the well being served by the pipeline.

4 VAC 25-150-730. General requirements.

A. Gathering pipelines shall be installed to be compatible with other uses of the area.

B. No permit shall be issued for a gathering pipeline to be installed closer than 50 feet from any inhabited building, unless site conditions as approved by the director warrant the use of a lesser distance and there exists a lease or agreement between the operator, the inhabitants of the building and the owner of the inhabited building. A copy of

the lease or agreement shall accompany the application for a permit.

C. ~~Materials.~~ Materials used in gathering pipelines shall be able to withstand anticipated conditions. At a minimum this shall include:

1. All plastic gathering pipeline connections shall be fused, not coupled.
2. All buried gathering pipelines shall be detectable by magnetic or other remote means from the surface.

D. All new gathering pipelines shall be tested to maintain a minimum of 110% of anticipated pressure prior to being placed into service.

E. All gathering pipelines shall be maintained in good operating condition at all times.

4 VAC 25-150-740. Operations plans.

~~A. In addition to the requirements of 4 VAC 25-150-100 of this chapter, every operations plan for a gathering pipeline shall contain: For a gathering pipeline, the operations plan shall be in a format approved by, or on a form prescribed by the director.~~

- ~~1. An accurate map or maps meeting the following requirements:

 - a. The proposed lines shall be located on maps depicting topography on a scale of not less than 1 inch equals 600 feet (1:7200); and
 - b. The total distance and width of the right-of-way and the diameter of the gathering pipelines shall be shown; and~~
- ~~2. Information identifying the materials to be used in the gathering pipeline system, the construction standards to be met, including the location of all drips, and the quality control testing program to be followed prior to putting the gathering pipeline into service.~~

~~B. On a form prescribed by the director, the operator shall indicate how risks to the public safety or to the site and adjacent lands are to be managed, and shall provide a short narrative, if pertinent.~~

Final Regulations

NOTICE: The forms used in administering 4 VAC 25-150-10 et seq., the Virginia Gas and Oil Regulation, are not being published due to the large number; however, the name of each form is listed below. The forms are available for public inspection at the Department of Mines, Minerals and Energy, 9th Street Office Building, Richmond, Virginia, or at the office of the Registrar of Regulations, General Assembly Building, 2nd Floor, Richmond, Virginia.

FORMS

Registration Form, DGO-GO-A (~~9/94~~), rev. 1/98.
Application for a New Permit, Permit Modification, or Transfer of Permit Rights, DGO-GO-1 (~~11/95~~), rev. 1/98.
Operator's Surety Bond, DGO-GO-2 (~~9/94~~), rev. 1/98.
Operator's Cash Bond, DGO-GO-3 (~~9/94~~), rev. 1/98.
Notice of Application for a Permit or Permit Modification, DGO-GO-4 (~~9/94~~), rev. [~~7/97~~ 1/98].
Persons Receiving Official Notice of Permit Application or Permit Modification, DGO-GO-5 (~~9/94~~), rev. 7/97.
Notice by Publication of an Application for a Permit, DGO-GO-6 (~~9/94~~), rev. 1/98.
Well Location Plat, DGO-GO-7 (~~9/94~~), rev. 1/98.
Information Sheet for Applications to Transfer Permit Rights, DGO-GO-8 (~~9/94~~), rev. 1/98.
Technical Data Sheet for Permit Applications Under § 45.1-361.29, DGO-GO-9 (Rev. 5/23/96).
Technical Data Sheet for Gathering Pipelines Pipelines and Associated Facilities, DGO-GO-10 (~~9/94~~), rev. 1/98.
Technical Data Sheet for Permit Modification to Plug or Replug, DGO-GO-11 (~~9/94~~), rev. 1/98.
~~Operation Operations Plan Requirements - Checklist~~, DGO-GO-12 (~~9/94~~), rev. 1/98.
~~Operation Operations Plan - Checklist~~, DGO-GO-12A (7/95; included in DGO-GO-12).
~~Certification of Location of a New Well~~, DGO-GO-13 (~~9/94~~).
Drilling Report, DGO-GO-14 (~~9/94~~), rev. 1/98.
Completion Report, DGO-GO-15 (~~9/94~~), rev. 1/98.
Application for Disposal of Pit or Produced Fluids, DGO-GO-16 (~~9/94~~), rev. 1/98.
Application to Complete Abandoned Gas or Oil Well as a Water Well, DGO-GO-17 (~~9/94~~), rev. 1/98.
Plugging Affidavit, DGO-GO-18 (~~9/94~~), rev. 1/98.
Monthly Gas Production Report, DGO-GO-19 (~~9/94~~), rev. 1/98.
Monthly Oil Production Report, DGO-GO-20 (~~9/94~~), rev. 1/98.

Notice of Right to Object, [DGO-GO-21,] rev. 10/96.

License to Perform - Plugging of Orphaned Well, DGO-GO-23, (~~11/96~~).

License to Perform - Plugging of Well/Bond Forfeiture, DGO-GO-24, (~~11/96~~).

Affidavit and Release in Support of Surface Owner's Application to the Virginia Division of Gas and Oil for Use of an Orphaned Well as a Water Well, DGO-GO-25, (~~11/96~~).

VA.R. Doc. No. R97-687; Filed September 18, 1998, 2:47 p.m.

TITLE 9. ENVIRONMENT

STATE AIR POLLUTION CONTROL BOARD

REGISTRAR'S NOTICE: The State Air Pollution Control Board has claimed an exemption from the Administrative Process Act in accordance with § 9-6.14:4.1 C 4 (c) of the Code of Virginia, which excludes regulations that are necessary to meet the requirements of federal law or regulations, provided such regulations do not differ materially from those required by federal law or regulations. The State Air Pollution Control Board will receive, consider and respond to petitions by any interested person at any time with respect to reconsideration or revision.

Title of Regulations: 9 VAC 5-20-10 et seq. **Regulations for the Control and Abatement of Air Pollution: General Provisions (Rev. A98) (amending 9 VAC 5-20-204 and 9 VAC 5-20-205).**

Statutory Authority: § 10.1-1308 of the Code of Virginia.

Effective Date: January 1, 1999.

Summary:

The amendments (i) revise the geographic delineation of the nonattainment areas to correspond to the recent federal promulgation and (ii) revise the geographic delineation of the prevention of significant deterioration areas to correspond to the recent federal promulgation.

Agency Contact: Copies of the regulation may be obtained from Alma Jenkins, Department of Environmental Quality, P.O. Box 10009, Richmond, VA 23240, telephone (804) 698-4070. Questions regarding the regulation should be addressed to Karen G. Sabasteanski, Policy Analyst, Department of Environmental Quality, P.O. Box 10009, Richmond, VA 23240, telephone (804) 698-4426.

9 VAC 5-20-204. Nonattainment areas.

Nonattainment areas are geographically defined below by locality for the criteria pollutants indicated. Following the name of each nonattainment area, in parentheses, is the classification assigned pursuant to § 181 (a) for ozone and § 186 (a) for carbon monoxide of the federal Clean Air Act (42 USC § 7511 (a) and 42 USC § 7512 (a)).

1. Ozone.

a. Northern Virginia Ozone Nonattainment Area (serious).

Arlington County	Alexandria City
Fairfax County	Fairfax City
Loudoun County	Falls Church City
Prince William County	Manassas City
Stafford County	Manassas Park City

b. ~~White Top Mountain Ozone Nonattainment Area (marginal rural transport area).~~

~~The portion above 4,500 feet elevation in Smyth County (located within the Jefferson National forest).~~

2. All other pollutants.

None.

9 VAC 5-20-205. Prevention of significant deterioration areas.

A. Prevention of significant deterioration areas are geographically defined below by locality for the following criteria pollutants:

1. Particulate matter.

AQCR 1 through 7 All areas

2. Sulfur dioxide.

AQCR 1 through 7 All areas

3. Carbon monoxide.

AQCR 1 through 7 All areas

4. Ozone (volatile organic compounds):

a. AQCR 1 All areas ~~except the portion of White Top Mountain above 4,500 feet elevation located in Smyth County~~

b. AQCR 2 All areas

c. AQCR 3 All areas

d. AQCR 4 All areas except Stafford County

e. AQCR 5 All areas

f. AQCR 6 All areas

g. AQCR 7 No area

5. Nitrogen oxides.

AQCR 1 through 7 All areas

6. Lead.

AQCR 1 through 7 All areas

B. All areas of the state are geographically defined as prevention of significant deterioration areas for the following pollutants:

Mercury
Beryllium
Asbestos
Fluorides
Sulfuric acid mist
Vinyl chloride

Total reduced sulfur:

Hydrogen sulfide
Methyl mercaptan
Dimethyl sulfide
Dimethyl disulfide

Reduced sulfur compounds:

Hydrogen sulfide
Carbon disulfide
Carbonyl sulfide

Municipal waste combustor organics (measured as total tetra-chlorinated through octa-chlorinated dibenzo-p-dioxins and dibenzofurans)

Municipal waste combustor metals (measured as particulate matter)

Municipal waste combustor acid gases (measured as the sum of SO₂ and HC1)

C. The classification of prevention of significant deterioration areas is as follows:

1. Class I.

a. Federal - James River Face Wilderness Area (located in AQCR 2) and Shenandoah National Park (located in AQCR 2 and AQCR 4).

b. State - None.

2. Class II - All areas of the state not designated in Class I.

3. Class III - None.

D. The area classification prescribed in subsection C of this section may be redesignated in accordance with 40 CFR 52.21(e), (g), (u) and (t).



COMMONWEALTH of VIRGINIA

VIRGINIA CODE COMMISSION

General Assembly Building

JANE D. CHAFFIN
REGISTRAR OF REGULATIONS

610 CAPITOL STREET
RICHMOND, VIRGINIA 23219
(804) 786-3591
FAX (804) 692-0625

September 29, 1998

Mr. Dennis H. Treacy, Director
Department of Environmental Quality
629 East Main Street
Richmond, Virginia 23219

Dear Mr. Treacy:

This office has received the amendments to the Regulations for the Control and Abatement of Air Pollution, specifically, 9 VAC 5-20-204 and 9 VAC 5-20-205 (Rev. A98) relating to nonattainment areas, filed by the State Air Pollution Control Board on September 23, 1998.

As required by § 9-6.14:4.1 C 4(c) of the Code of Virginia, I have determined that these amendments are exempt from Article 2 of the Administrative Process Act since they do not differ materially from those required by federal law or regulation.

Sincerely,

A handwritten signature in cursive script that reads 'Jane D. Chaffin'.

Jane D. Chaffin
Registrar of Regulations

JDC/tmgj

VA.R. Doc. No. R98-26; Filed September 23, 1998, 11:23 a.m.

TITLE 12. HEALTH

DEPARTMENT OF MEDICAL ASSISTANCE SERVICES

Withdrawal of Final Regulation and Notice of Change

Title of Regulation: **12 VAC 30-100-10 et seq. State Programs: Part IV, Health Insurance Program for Working Uninsured Individuals (withdrawing 12 VAC 30-100-420, Program subscribers).**

The Department of Medical Assistance Services has withdrawn 12 VAC 30-100-420, Program subscribers, of the Health Insurance for the Working Uninsured, which was published as a final regulation in 14:25 VA.R. 4070-4076 August 31, 1998. 12 VAC 30-100-420 will not become effective on October 1, 1998.

In the near future, the Department of Medical Assistance Services intends to modify this section as it was published in the August 31, 1998, Register. Even though a formal objection is not being submitted pursuant to §§ 9-6.14:9.1 and 9-6.14:9.2 of the Code of Virginia, the agency has been directed to reinsert the requirement that program subscribers be residents of the Commonwealth in order to participate in this program. The agency will be modifying 12 VAC 30-100-420 accordingly under the authority of the director.

Agency Contact: Victoria P. Simmons, Regulatory Coordinator, Department of Medical Assistance Services, 600 East Broad Street, Suite 1300, Richmond, VA 23219, telephone (804) 371-8850.

VA.R. Doc. No. R97-338; Filed September 29, 1998, 5:09 p.m.



TITLE 19. PUBLIC SAFETY

DEPARTMENT OF STATE POLICE

Title of Regulation: **19 VAC 30-70-1 et seq. Motor Vehicle Safety Inspection Rules and Regulations (amending 19 VAC 30-70-500).**

Statutory Authority: § 46.2-1165 of the Code of Virginia.

Effective Date: November 11, 1998.

Summary:

The Virginia Official Inspection Manual provides guidelines for the annual inspection of all automobiles in the Commonwealth of Virginia. The amendments are being made to comply with federal and state legislative changes. The opportunity is also being used to make several clarifications and eliminate references to obsolete terms.

Summary of Public Comments and Agency's Response: A summary of comments made by the public and the agency's response may be obtained from the promulgating agency or viewed at the office of the Registrar of Regulations.

Agency Contact: Copies of the regulation may be obtained from Captain W. Steven Flaherty, Department of State Police, P.O. Box 27472, Richmond, VA 23261, telephone (804) 378-3479. There will be a charge of \$10 for copies.

19 VAC 30-70-5. Class III offenses.

Class III offenses shall be violations of those sections of the Annual Motor Vehicle Inspection Manual considered most critical from a safety viewpoint. They would consist of the omission of checking or improper approval of an item so critical to the safe operation of a motor vehicle as to have the potential of being the imminent cause or factor of a motor vehicle crash. A violation of the following sections of the Annual Motor Vehicle Inspection Manual shall constitute a Class III offense unless designated otherwise:

- 19 VAC 30-70-10 J
- 19 VAC 30-70-10 P, P1, P2
- 19 VAC 30-70-80 in its entirety (except subdivision B 3)
- 19 VAC 30-70-90 in its entirety
- 19 VAC 30-70-100 in its entirety
- 19 VAC 30-70-110 in its entirety
- 19 VAC 30-70-120 in its entirety
- 19 VAC 30-70-130 in its entirety
- 19 VAC 30-70-140 in its entirety
- 19 VAC 30-70-160 I 10 h and 11 f
- 19 VAC 30-70-160 I 10 g and 11 g (2)
- 19 VAC 30-70-190 in its entirety
- 19 VAC 30-70-220 in its entirety
- 19 VAC 30-70-340 in its entirety
- 19 VAC 30-70-350 in its entirety
- 19 VAC 30-70-360 A and B
- 19 VAC 30-70-360 D 15 through D 22
- 19 VAC 30-70-370 in its entirety
- 19 VAC 30-70-400 in its entirety
- 19 VAC 30-70-440 in its entirety (except subsection subdivision B 2)
- 19 VAC 30-70-450 in its entirety
- 19 VAC 30-70-460 in its entirety
- 19 VAC 30-70-470 in its entirety
- 19 VAC 30-70-480 in its entirety
- 19 VAC 30-70-490 in its entirety

Final Regulations

19 VAC 30-70-500 in its entirety

19 VAC 30-70-510 in its entirety

19 VAC 30-70-530 H 10 i and 11 g (2)

19 VAC 30-70-560 in its entirety

19 VAC 30-70-590 in its entirety

Disciplinary action for a Class III offense shall be:

1st offense - Written reprimand from the Safety Officer or his designee.

2nd offense - Suspension for not less than 45 nor more than 90 days.

Offenses are cumulative in nature and will remain active for a period of 24 months from date of offense.

A Class III offense in combination with two Class II offenses or three Class I offenses shall be grounds for no less than a 60-day nor more than 90-day suspension.

19 VAC 30-70-7. General information.

Any violation under any class of offenses requiring a third suspension within a 24-month period shall be grounds for a revocation. The suspension or revocation period for a subsequent violation requiring suspension or revocation under any class of offenses within a 24-month period shall be twice that of a previous suspension or revocation.

For suspension periods of less than six months, inspection stations and safety inspectors will not be required to file application for reinstatement.

For suspension periods of six months or more, inspection stations and safety inspectors must complete the process as set forth for original appointment. Reapplications may be made 60 days prior to the suspension expiration. *Suspended inspectors shall contact the nearest safety office or supervising trooper to request reinstatement.*

Inspection stations and safety inspectors who have their privilege to perform inspections revoked, must complete the application process as set forth for original appointments after the expiration of the period of revocation.

19 VAC 30-70-10. Official inspection station requirements.

A. Official inspection stations, except private appointments, shall be open at least eight hours of each normal business day, and shall be able to perform inspections 12 months throughout the year, except during illness of limited duration or normal vacation.

1. Normal business hours are defined as an eight-hour period of time between 8 a.m. and 6 p.m.

2. Stations are not prohibited from performing inspections at times other than during normal business hours.

3. A station which advertises inspections beyond normal business hours shall be able to perform such inspections.

4. If a station desires to maintain business hours which are different from those defined in this section, written permission must be obtained from the safety officer and a sign setting forth the inspection hours must be posted conspicuously at the station where it can be observed by a person desiring to have a vehicle inspected.

B. At least one safety inspector to perform inspections and one inspection lane, meeting the minimum requirements, shall be available for inspection at all times during the normal business day. All inspections must be made only at the locations and in the inspection lane approved by the Department of State Police.

The designated inspection areas, including any location where customers are permitted to enter when submitting vehicles for inspection, must be kept clean, free from excessive dirt, grease, and loose materials.

C. Inspection station facilities must be properly maintained and must present a businesslike appearance to the general public. Property adjacent to the inspection station which is owned or controlled by the station must be free of debris, litter, used parts and junk vehicles. Vehicles properly contained within fenced storage areas shall be deemed to comply with this requirement.

D. Inspections shall be performed on a first come, first serve basis. Motorists shall not be required to make an appointment to obtain an inspection, except that appointments required by paragraph 12 of the Governor's Proclamation, which appears at the end of this chapter, shall be made. Businesses that take in motorists' vehicles for inspection at the beginning of the work day shall not be required to stop the work already taken in to provide an inspection for a drive-in motorist, provided inspections are actually being performed at the time and will continue through the day.

E. Safety inspectors, managers who supervise inspection activities and business owners through participation in the inspection program are representatives of the Department of State Police and should conduct themselves in a manner to avoid controversy in dealing with customers presenting vehicles for inspection. The use of profanity or verbal abuse directed at customers presenting their vehicles for inspection will be grounds for suspension from participation in the inspection program and will be considered a Class IV offense as set forth in 19 VAC 30-70-6 of the Guidelines for Administration of Virginia's Annual Motor Vehicle Inspection Program.

Controversy that cannot be calmly resolved by the safety inspector, managers, and owners should be referred to the supervising trooper for handling.

F. The "Certificate of Appointment" must be framed under glass and posted at or near the point of inspection where it can be observed and read by a person submitting a vehicle for inspection.

G. The required "Official Inspection Procedure" sheet furnished each station must be framed under glass and posted conspicuously where it can be observed and read by a person submitting a vehicle for inspection.

H. The poster designating the station as an official inspection station shall be posted in a prominent location, outside or visible outside the station to alert passersby that inspection services are available. Private inspection stations need not comply with this section.

I. Each official inspection station shall display a list with the name(s) and license expiration date of all employees licensed to inspect at that station adjacent to the appointment certificate, where it can be observed by a person submitting a vehicle for inspection.

The official inspection manual will be kept at or near the point of inspection for ready reference.

J. Important - Any change in name, ownership or location of any official inspection station cancels the appointment of that station and the Department of State Police must be notified immediately. The department shall be notified when an official inspection station discontinues operation.

K. All inspection supplies, inspection binders and manual, unused stickers, duplicates of certificates issued, bulletins, and other forms are the property of the Department of State Police and must be safeguarded against loss.

L. Inspection supplies issued to an inspection station can be used only by that station and are not to be loaned or reissued to any other station with the exception of inserts.

1. Stations must maintain a sufficient supply of approval stickers, T/M decals and rejection stickers.

2. Inspection stations that exhaust their supply of approval stickers, rejection stickers or T/M decals, shall immediately stop performing new inspections and contact their supervising trooper or the nearest Safety Division office.

M. All losses of stickers must be reported orally at once to the nearest State Police area safety office or supervising inspection trooper.

N. Every precaution against the loss of stickers must be taken. If the loss occurs through carelessness or neglect, a suspension of the station may result.

O. Manuals, bulletins, other regulations and lists of approved equipment must be available at all times for reference. Revisions to the inspection manual must be inserted in the manual at the proper location promptly after being received by the inspection station. Bulletins of temporary interest and pages of bulletins containing the synopsis of manual revisions will be retained in the front of each station's inspection manual for two years. Each safety inspector shall review the material contained in each inspection bulletin and manual revision within 15 days of its receipt. The safety inspector shall certify that the revisions have been reviewed by signing his/her name and placing the date reviewed by the signature on the bottom or reverse side

of the bulletin or manual revision cover sheet. Station management shall be responsible to see that each safety inspector is familiar with all bulletins and manual revisions and shall be required to furnish evidence to the department that all bulletins and manual revisions have been reviewed by each licensed inspector.

A copy of the diagram drawn by the investigating trooper, showing the approved inspection lane or lanes will be inserted in a plastic page protector and inserted as the last page of the official inspection manual at each official inspection station. The name of the station and the date will be inserted in the top right corner.

P. Private appointment may be made of company stations or government stations who own and operate a minimum of 20 vehicles and they may inspect only company-owned or government-owned vehicles respectively. When authorized by the department, they may inspect vehicles of a wholly owned subsidiary or leased vehicles.

1. A private station may perform inspections during each month of the year or may elect to inspect only during certain designated months.

2. A private station not electing to inspect vehicles every month of the year which finds it necessary to inspect a vehicle during a month other than those selected for inspection may issue a sticker to the vehicle from the nearest past inspection month.

Q. All official inspection station owners, operators and certified safety inspectors shall comply with the Virginia inspection laws and the inspection rules and regulations. Reports of violations will be investigated and if found to be valid may result in the suspension of the station, suspension of the mechanic, possible court action or other appropriate action. Repeated violations or serious violations may result in a revocation of the station appointment by the Superintendent.

R. The arrest of any person associated with the inspection program for a criminal offense of a nature which would tend to immediately reflect upon the integrity and reputation of the Department of State Police shall be grounds for an immediate suspension and the conviction for such an offense may result in a revocation of the station appointment.

S. When a station has been suspended or revoked, it must release to a member of the Department of State Police all inspection supplies, posters, and papers including the certificate of appointment. Failure to do so is a violation of § 46.2-1172 of the Code of Virginia.

T. The authority of the Superintendent to suspend the designation or appointment of an official inspection station as provided in § 46.2-1163 of the Code of Virginia, or to suspend the certification of a mechanic designated to perform inspections at an official inspection station in keeping with the provisions of § 46.2-1166 of the Code of Virginia, is hereby delegated to any of the following supervisory ranks of the Department of State Police:

Final Regulations

"Lieutenant Colonel, Major, Captain, Lieutenant and, First Sergeant and Sergeant."

19 VAC 30-70-50. Approval stickers and decals.

A. If the vehicle meets all inspection requirements, the inspection sticker receipt shall be legibly filled out with a ball point pen in its entirety and signed by the authorized mechanic making the inspection. The inspection fee, the cost of the repairs relating to the inspection and the identification number must be included.

B. Approval stickers and decals shall be issued according to the following schedule:

ANNUAL PROGRAM

Vehicles inspected in January	issued stickers bearing the Number "1"
Vehicles inspected in February	issued stickers bearing the Number "2"
Vehicles inspected in March	issued stickers bearing the Number "3"
Vehicles inspected in April	issued stickers bearing the Number "4"
Vehicles inspected in May	issued stickers bearing the Number "5"
Vehicles inspected in June	issued stickers bearing the Number "6"
Vehicles inspected in July	issued stickers bearing the Number "7"
Vehicles inspected in August	issued stickers bearing the Number "8"
Vehicles inspected in September	issued stickers bearing the Number "9"
Vehicles inspected in October	issued stickers bearing the Number "10"
Vehicles inspected in November	issued stickers bearing the Number "11"
Vehicles inspected in December	issued stickers bearing the Number "12"

All February annual inspection stickers and trailer/motorcycle decals (#2) due to expire at midnight, February 28 automatically will be valid through midnight February 29 each leap year.

C. The numeral decal indicating the month of expiration shall be inserted in the box identified as month and the numeral decal indicating the year of expiration shall be inserted in the box identified as year of the approval sticker and the trailer/cycle decal. Extreme care should be used by inspectors in applying these inserts. On all windshields, except school buses, the sticker is to be placed at the bottom

of the windshield so that the inside or left edge of the sticker is one inch to the right of the vertical center of the windshield when looking through the windshield from inside the vehicle. (If the vehicle is normally operated from the right side, the sticker must be placed one inch to the left of the vertical center of the windshield.) On passenger vehicles not equipped with a windshield, the sticker shall be placed on or under the dash and protected in some manner from the weather.

The approval sticker on official yellow school buses is to be placed at the bottom and in the right corner of the windshield when looking through the windshield from inside the vehicle.

EXCEPTION: The approval sticker shall be placed one inch to the right of the vertical center of the windshield when looking through the windshield from the inside on all new flat-face cowl yellow school buses.

Stickers or decals used by counties, cities and towns in lieu of license plates affixed adjacent to the old approval sticker and which are affixed in the location where the new approval sticker is required to be placed will not be removed. In these cases, the approval sticker will be placed as close to one inch to the right of the vertical center of the windshield as it can be placed without removing or overlapping the county, city or town decal.

D. The Virginia statutes require that the inspection sticker be displayed on the windshield or at other designated places at all times. The inspection sticker cannot be transferred from one vehicle to another.

EXCEPTION: If the windshield in a vehicle is replaced, a valid sticker may be removed from the old windshield and placed on the new windshield.

E. The decal issued to a motorcycle shall be affixed to the front left side of the cycle on a flat surface or left front shock where it will be visible after mounting.

F. Trailer decals will be issued to all trailers and semitrailers required to be inspected. (No boat, utility, or travel trailer which is not equipped with brakes shall be required to be inspected.)

G. All trailers must display a trailer decal on that particular vehicle. These decals are to be placed on the left side of the trailer near the front corner. The decal must be affixed to the trailer body or frame. In those instances where a metal back container with a removable transparent cover has been permanently affixed to the trailer body, the decal may be glued to it. The container must be permanently mounted in such a manner that the decal must be destroyed to remove it.

H. In all other cases involving unusually designed trailers such as pole trailers, the inspecting mechanic is to exercise his own good judgment in placing the decal at a point where it will be as prominent as possible and visible for examination.

I. Decals shall be punched to indicate whether issued to a motorcycle or trailer. (The type vehicle being inspected shall be punched.)

The receipts are completed in the same manner as other inspection receipts.

J. Appointed stations will keep sufficient inspection supplies on hand to meet their needs. Requests for additional supplies are to be made to the Safety Division by telephone or in writing. *Requests for supplies that are to be picked up at the Safety Division headquarters must be made at least 24 hours prior to pick up.*

1. Do not make requests for stickers on inventory forms or slips of paper enclosed with returned supplies.

2. Packing slips mailed with inspection supplies will be kept on file at the station for at least 24 months.

K. All unused center inserts used to indicate the month that a sticker or decal expires, in possession of the inspection station at the end of each month shall be retained by the inspection station, properly safeguarded, and used in the inspection of vehicles for the particular month in the following year or be disposed of as directed by the Department of State Police.

All inspection supplies that are voided, damaged, disfigured or become unserviceable in any manner, will be returned to the Safety Division, Department of State Police and replacement supplies will be furnished the station. Expired stickers will be picked up by the station's supervising trooper.

L. The white receipts shall be left in completely used books of approval stickers and decals. Used white receipts shall be removed from all partly used books of approval stickers and decals at the end of each month *and placed in numerical order*. All receipts will be forwarded to the Safety Division by the fifth of the month following the month of inspection. All voided approval stickers and decals shall be marked void and returned with the white receipts.

M. The pink receipt copies of the approval stickers and decals shall be given to the owner or operator of the vehicle.

N. All yellow receipt copies of approval stickers and decals shall be kept on file at the station for at least 24 months. They may be inspected by any law-enforcement officer during normal business hours.

O. Safety Division troopers may replace inspection stickers that have separated from the windshield of motor vehicles and become lost or damaged without conducting an inspection of the safety components of the vehicle. Such replacement of inspection stickers shall be made only in accordance with the following provisions:

1. A vehicle owner or operator complaining of the loss or damage to the inspection sticker on the windshield of their vehicle due to separation of the sticker from the windshield shall be directed to the nearest Safety Division office or Safety Division trooper.

2. Safety Division troopers, upon receipt of a complaint from a vehicle owner or operator that their inspection sticker has been stolen, lost or become damaged due to separation from the windshield will make arrangements to meet the person to effect the replacement of the sticker. A vehicle owner or operator alleging theft of the inspection sticker will furnish proof to the Safety Division trooper that such theft has been reported to proper law-enforcement authority.

3. The vehicle owner or operator must produce the original pink inspection receipt indicating a valid approval inspection sticker was issued to the vehicle within the past 11 months. (The vehicle must be reinspected if the expiration of the original inspection sticker is in the month the request is being made.)

4. The Safety Division trooper will verify by the inspection receipt that the vehicle was issued an approval inspection sticker within the past 11 months and issue a replacement inspection sticker to the vehicle.

5. The Safety Division trooper will complete the inspection sticker receipt for the approval sticker from information contained on the original receipt. The date the replacement sticker is issued will be used in the date space. In the space for "Inspection Related Charges," the trooper will insert the word "REPLACEMENT" and the sticker number from the original pink inspection receipt.

6. The Safety Division trooper will sign the receipt vertically in the O.K. column in the "Equipment Inspected" blocks. These blocks will not otherwise be completed.

7. The Safety Division trooper shall place month and year inserts on the inspection sticker to reflect the expiration as shown on the original approval inspection sticker and place the inspection sticker on the windshield in accordance with the requirements of subsection C of this section.

8. The Safety Division trooper will staple the original pink inspection receipt to the new white receipt. At the end of each week, the Safety Division trooper will forward all inspection receipts for replacement stickers issued by him to the Safety Division. The yellow receipts will be submitted to the area office and maintained on file for 24 months.

19 VAC 30-70-70. Inventory.

A. Each inspection station at the end of each quarter, shall fill in the applicable portion of an inspection sticker inventory report (Form SP-221) in duplicate on stickers, trailer/motorcycle decals and rejection stickers used. This report shall be completed by the fifth of April, July, October and January for the preceding quarter and shall be kept on file at the station.

1. At the end of the calendar quarter the monthly totals will be combined into a quarterly total reflecting total

Final Regulations

number of stickers, trailer/motorcycle decals, rejection stickers and voided stickers used during the quarter. All approval stickers, trailer/motorcycle decals and rejection stickers unused and on hand at the end of the quarter shall be listed in the space provided on ~~the back of~~ the inventory report (Form SP-221-).

2. The inventory report after its completion shall be retained at the inspection station until it is reviewed and picked up by the station's supervising trooper during his supervisory visit. The other copy of the inventory report shall be retained by the station for at least 24 months.

B. The calendar quarterly inventory reports shall be completed according to the following schedule:

Quarter of Year	Months of
1st	January, February, March
2nd	April, May, June
3rd	July, August, September
4th	October, November, December

19 VAC 30-70-80. Service brakes.

A. The inspector, as a minimum, must drive all vehicles into the inspection lane and test both service and parking brakes.

B. A minimum of two wheels or two wheels and drums, one front and one rear, must be removed from each passenger and multi-purpose vehicle with a gross vehicle weight rating of 10,000 pounds or less at the time of inspection, except those listed in subdivisions 1, 2 and 3 below. Two front wheels or two front wheels and drums must be removed from vehicles listed in subdivision 3 below.

1. Motorcycles.

2. A new model vehicle, is defined as a vehicle that has not been titled or leased and is less than one year old, measured from October 1 as of each year; or if such motor vehicle does not have a model year, such measurement shall be made from the date of manufacture.

3. Trucks with floating axles that require seal replacement upon removal of rear wheels. The inspection receipt (approval and rejection) shall be marked to reflect which wheels were pulled.

Warning: Lug nuts must be torqued to the manufacturer's specifications to prevent damage to disc rotors. The use of an impact wrench may exceed the manufacturer's specifications and damage disc rotors.

C. If any braking problem is detected, the inspector may test drive or require a test drive of the vehicle ~~and use the decelerometer as necessary. If the decelerometer is used and the vehicle does not meet the minimum standards for stopping distances as shown in subdivision F11 of this section, the vehicle shall be rejected.~~

D. Inspect for and reject if:

1. Vehicle is not equipped with brakes, or any brake has been disconnected, rendered inoperative, or improperly installed. Trailers having an actual gross weight of less than 3,000 pounds are not required to be equipped with brakes; however, if brakes are installed, these vehicles must be inspected.

Brake System Failure Indicator Lamp

2. Passenger vehicles manufactured after January 1, 1968, are not equipped with a brake failure warning lamp or warning lamp does not light with parking brake applied when ignition key is turned to the start position, except for anti-lock system. With engine running and parking brake released, the lamp should go off, except for vehicles equipped with anti-lock system. Apply service brake for 10 seconds. If the brake warning lamp lights again, the warning light does not come on when there is a leak, or the light is not functioning properly, the system is defective. NOTE: This paragraph does not apply to vehicles registered as street rods.

Brake Linings and Disc Pads

3. Riveted linings or disc pads are worn to less than 2/32 of an inch over the rivet head(s).

4. Bonded or molded linings or disc pads are worn to less than 2/32 of an inch in thickness or are worn beyond manufacturer's specifications.

5. Wire in wire-backed lining is visible in friction surface.

6. Snap-on brake linings are loose.

7. Any lining is broken or cracked so that lining or parts of lining are not firmly attached to the shoe or has cracks on the friction surface extending to the open edge.

8. Grease or other contamination cannot be satisfactorily removed from the lining, drums, or rotors.

9. Rivets in riveted linings are loose or missing.

10. Any lining or pad is misaligned or does not make full contact with the drum or rotor.

Brake Drums and Discs

11. Brake drums or brake discs (rotors) are worn or scored to the extent that their remachining would ~~exceed~~ result in a failure to meet manufacturer's specifications.

12. Brake drums or discs have any external crack or cracks more than one half the width of the friction surface of the drum or disc. NOTE: Do not confuse short hairline heat cracks with flexural cracks.

Mechanical Linkage

13. Cables are frayed or frozen.

14. Mechanical parts missing, broken, badly worn, or misaligned.

E. Hydraulic.

NOTE: Some motor vehicles, beginning with 1976 models, have a hydraulic power system that serves both the power assisted brakes and power assisted steering system. Some vehicles, beginning with 1985 models, have an integrated hydraulic actuation and anti-lock brake unit using only brake fluid.

1. Brake hydraulic system. Inspector should check the brake hydraulic system in the following manner: test vehicle in a standing position; apply moderate pressure to the brake pedal for 10 seconds. Brake pedal height must be maintained. On vehicles equipped with power assisted systems, the engine should be running.

2. Hydraulic system operation. Stop engine, then depress brake pedal several times to eliminate all pressure. Depress pedal with a light foot-force (30 pounds). While maintaining this force on the pedal, start engine and observe if pedal moves slightly when engine starts.

Reject vehicle if pedal does not move slightly as engine is started while force is on brake pedal.

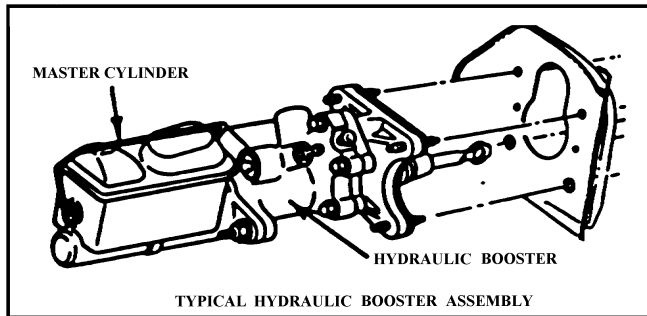

3. Condition of hydraulic booster power brake system. Inspect system for fluid level and leaks.

Reject vehicle if there is insufficient fluid in the reservoir; if there are broken, kinked or restricted fluid lines or hoses; if there is any leakage of fluid at the pump, steering gear or brake booster, or any of the lines or hoses in the system; or if belts are frayed, cracked or excessively worn.

4. Integrated hydraulic booster/anti-lock system operation. With the ignition key in the off position, depress brake pedal a minimum of 25 times to deplete all residual stored pressure in the accumulator. Depress pedal with a light foot-force (25 pounds). Place ignition key in the on position and allow 60 seconds for the brake warning light to go out and the electric pump to shut off.

Reject vehicle if the brake pedal does not move down slightly as the pump builds pressure or if the brake and anti-lock warning lights remain on longer than 60 seconds.

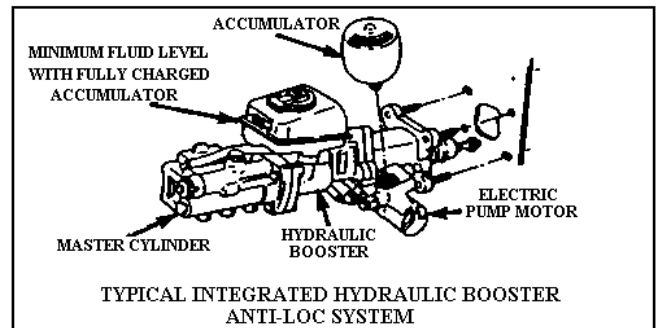

5. Condition of integrated hydraulic booster/anti-lock system with electronic pump. With the system fully charged, inspect system for fluid level and leaks.

Reject vehicle if there is insufficient fluid in the reservoir; if there are broken, kinked or restricted fluid lines or hoses; or if there is any leakage of fluid at the pump or brake booster, or any of the lines or hoses in the system.

6. Vacuum system operation. Stop engine then depress brake pedal several times to eliminate all vacuum in the system. Depress pedal with a light foot-force (25 pounds). While maintaining this force on the pedal, start engine and observe if pedal moves down slightly when engine starts.

Reject vehicle if pedal does not move down slightly as engine is started while force is on the brake pedal. In full vacuum-equipped vehicles, there is insufficient vacuum reserve for one full service brake application after engine is stopped.

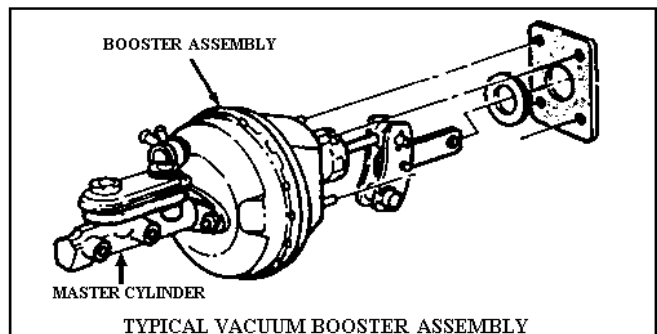

7. Condition of vacuum booster power brake system. Reject vehicle if there are collapsed, cracked, broken, badly chafed or improperly supported hoses and tubes, loose or broken hose clamps.

F. Inspect for and reject if:

General Specifications - Hydraulic Brakes

1. There is any leakage in the master cylinder, wheel cylinders, or brake calipers. (Do not disturb the dust boot when checking for leaking wheel cylinders.)

2. Fluid level in master cylinder is below the proper level for the particular vehicle.

Final Regulations

3. There is any evidence of a caliper sticking or binding.

Electric Brake System

4. Trailers show an amperage value more than 20% above or 30% below the brake manufacturer's maximum current rating for each brake.
5. Ammeter shows no reading or indicator is not steady on application and release of brake controller.
6. Any terminal connections are loose or dirty; wires are broken, frayed, or unsupported; any single conductor or nonstranded wire or wires below size recommended by brake manufacturers are installed.
7. Electrical trailer brakes do not apply automatically when breakaway safety switch is operated.

General Specifications

8. There is any leakage in any hydraulic, air, or vacuum lines; hoses have any cracks, crimps, restrictions, or are abraded exposing fabric; tubing or connections leak, are crimped, restricted, cracked or broken; any valves leak or are inoperative.

Reject the vehicle if the brake hoses or lines are stretched or extended and do not allow for suspension movement.

9. Brakes are not equalized so as to stop the vehicle on a straight line.
10. There is less than 1/5 reserve in actuator travel of the service brake when fully applied on all hydraulic, mechanical, or power-assisted hydraulic braking systems.
11. When tested on dry, hard, approximately level road free from loose material, at a speed of 20 miles per hour without leaving a 12-foot wide lane, ~~a brake machine or decelerometer reading~~ *results* in excess of the following distances is obtained: (When in doubt about a vehicle's stopping ability, the inspector shall conduct a road test.)

- a. Any motor vehicle (except motorcycles, trucks, and tractor-trucks with semitrailers attached) four wheel brakes—25 feet.
- b. Any motor vehicle (except motorcycles, trucks, and tractor-trucks with semitrailers attached) two wheel brakes—45 feet.
- c. All combinations of vehicles—40 feet.

19 VAC 30-70-90. Brakes: emergency, parking, or holding.

Some vehicles are equipped with an actual emergency brake, while others have only a parking or holding brake. Some types may be actuated by a foot or hand lever, while others may incorporate a switch or valve to actuate the brake. Air and vacuum brake systems may employ spring activating parking brakes.

Inspect for and reject if:

1. Vehicle or combination of vehicles is not equipped with a parking, holding, or emergency brake in good working order of the type installed as original standard factory equipment for the vehicle on which it is installed.

2. The parking brake actuating mechanism does not fully release when the control is operated to the off position.

3. Any mechanical parts are missing, broken, badly worn, or are inoperative.

4. Cables are stretched, worn, or frayed or not operating freely.

5. Parking brake will not hold the vehicle stationary with the engine running at slightly accelerated speed with shift lever in drive position for automatic transmission or shift lever in low gear with clutch engaged for standard shift transmission.

6. *Holding brake will not disengage when engine is started and vehicle is placed in drive. Holding brake will not hold vehicle stationary with foot on holding brake and vehicle in drive.*

7. On vehicles equipped with automatic transmissions, the vehicle will start in any gear other than (P) park and (N) neutral.

- ~~7.~~ 8. Passenger vehicles manufactured after January 1, 1968, are not equipped with a brake failure warning lamp or warning lamp does not light with parking brake applied when ignition key is turned to the start position, except for anti-lock system. With engine running and parking brake released, the lamp should go off, except for vehicles equipped with anti-lock system. Apply service brake for 10 seconds. If the brake warning lamp lights again, the warning light does not come on when there is a leak, or the light is not functioning properly, the system is defective. NOTE: This paragraph does not apply to vehicles registered as street rods.

19 VAC 30-70-100. Brakes: trailer (GVWR less than 10,000 pounds).

Inspect for and reject if:

1. Trailer brakes do not comply with 19 VAC 30-70-80 and 19 VAC 30-70-90.

2. Operator does not have full control over brakes.

- ~~3. Combination will not stop as required in 19 VAC 30-70-80 F 11 c.~~

3. All trailers, manufactured or assembled after January 1, 1964, registered for an actual gross weight of 3,000 pounds or more are not equipped with emergency breakaway brakes designed to:

- a. Apply automatically upon breakaway from towing vehicle.
- b. Remain fully applied for at least 15 minutes.

c. Apply and release by operation of the manual emergency control.

5- 4. A minimum of one wheel must be removed from each axle equipped with brakes to inspect the brake components.

NOTE: Trailers registered for an actual gross weight of 3,000 pounds or more, but with a manufacturer's gross weight rating of less than 10,000 pounds need not be equipped with brakes on all wheels.

a. Exception: Wheels on trailers equipped with open brake mechanisms are not required to be removed.

b. The inspection receipt approval and rejection shall be marked to reflect on which side the wheel or wheels were pulled.

19 VAC 30-70-140. Headlamps; except motorcycles.

A. Inspect for and reject if:

1. Any motor vehicle is not equipped with headlamps of an approved type.
2. Headlights are not of the same approved type except sealed beam headlamps. At least two headlamps are required.
3. In any headlamp the lens is cracked, broken, discolored, or rotated away from the proper position, or the reflector is not clean and bright.
4. Moisture or water buildup in headlamp is such that it affects the aimable pattern.
5. Lens is other than clear.
6. Bulbs are not of an approved type or are over 32 candlepower. (Sealed beam lamps including the ones which permit the use of a replacement halogen bulb are the only lamps approved with over 32 candlepower.) Ordinary lenses and reflectors were not designed for over 32 candlepower bulbs.
7. Any filament or bulb in headlamps fails to burn properly or headlamps are not at the same location or configuration as designed by manufacturer. (Location and type of headlamps can be found in subsection E of this section.)
8. Wiring is dangling or connections are loose, or if proper filaments do not burn at different switch positions, or if switches-including foot or hand dimmer-do not function properly, and are not convenient to the driver.
9. Foreign material is placed on or in front of the headlamp lens or interferes with the beam from the lamp. No glazing may be placed over or in front of the headlamps unless it is a part of an approved headlamp assembly.
 - a. Reject if vehicle has wire, unapproved plastic covers, any other materials which are not original

equipment or any colored material placed on or in front of the headlamps.

b. Vehicles registered as street rods may have clear, rigid plastic or glass headlamp lens covers in front of sealed beam units to replace original manufacturer's equipment.

10. Lamps can be moved easily by hand due to a broken fender or loose support, or if a good ground is not made by the mounting.

11. A headlamp visor is over two inches long unless part of the original body design.

12. The high beam indicator in the driver's compartment does not burn when the high or "country" beam is on or does not go off when the low beam is on. (Vehicles not originally equipped with an indicator are not required to comply unless sealed beam headlamps have been installed.)

B. Aiming the headlamps.

1. Headlamps shall be checked for proper aim by using either an optical or a mechanical headlamp aimer on every motor vehicle inspected, except vehicles with on-board aimers.

Headlamp aim on vehicles with on-board aimers shall be checked by visually examining the leveling device mounted either on or adjacent to the headlamp. Reject the vehicle if the leveling device shows the headlamp adjustment to exceed indicated specifications.

NOTE: Driving lamp and fog lamps must be aimed using the optical or ~~mechanical~~ aimer, according to instructions in 19 VAC 30-70-160 l 10 i and 11 g (2).

2. Headlamps are not aimed within the following tolerances using the optical aimer.

a. The center of the hot spot of all single element high beam lamps is set more than four inches up or down from the horizontal centerline or more than four inches to the left or right from the vertical centerline.

b. The left edge of the lamp pattern of any low beam lamp or any combination or multi-element lamp is more than four inches to the left or right of the vertical centerline or the top edge of the lamp pattern is more than four inches above or below the horizontal centerline when checked on low beam.

C. Optical aimer.

1. Approved optical headlamp machines may be used to properly aim any of the headlamps. Optical aimers must be properly calibrated and used in the manner recommended by the manufacturer.

The optical headlamp machine must be aligned to the vehicle in accordance with the manufacturer's specifications.

2. When aiming headlamps, first look for the type of lamp, which will be found embossed on the lens. The

Final Regulations

type determines which aiming requirements must be followed for the optical aimer.

3. All low beam or combination/multi-element headlamps must be set by aiming the lamp pattern with the lamps set on low beam.

4. Pattern should be aimed so that the left edge does not extend to the left or right of straight ahead, and the top of the pattern should be even with the horizontal.

Pattern "A" represents the light pattern as it should appear on the view screen of the approved aimer.

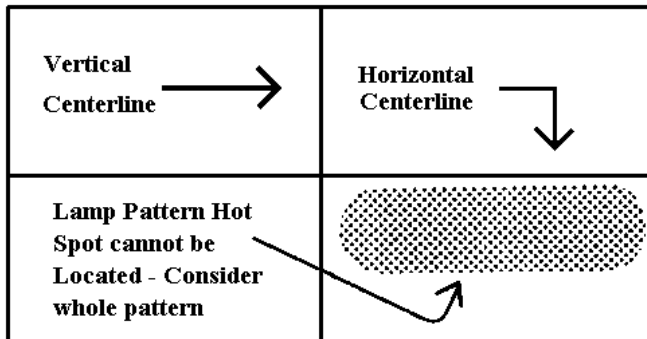

PATTERN A - COMBINATION MULTI-ELEMENT OR LOW BEAM LAMP

5. All single element high beam headlamps shall be set by aiming the center of the hot spot with the lamps set on high beam.

6. Aim straight ahead-center of the hot spot should be centered with the vertical and horizontal centerlines.

Pattern "B" represents the light pattern as it should appear on the view screen of the approved aimers.

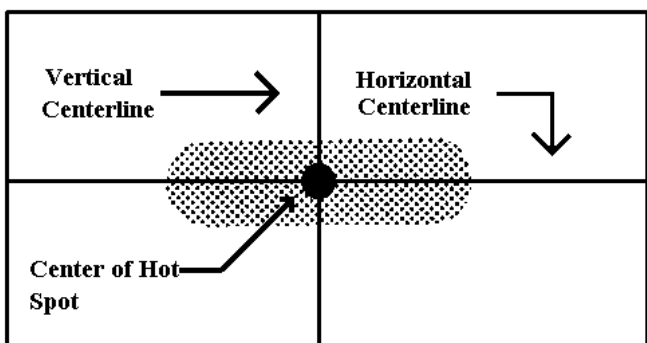

PATTERN B - SINGLE ELEMENT HIGH BEAM LAMP

7. When lamp pairs are mounted horizontally, the low beam lamp must be on the outer side and when mounted vertically, the low beam lamp must be at the higher position in the pair.

8. The four headlamp system must be wired so that only the lower beam lamp will burn when the light beams are depressed. When switched to high beams, both high beam and low beam may burn.

The "F" type halogen headlamp 1986 (LF-UF) of the four headlamp system will function in the following manner: system must be used so the low beam does not burn with the high beam.

D. Mechanical aimers.

1. Mechanical aimers can be used to aim only those headlamps that have "aiming" pads molded into the lens.

2. Mechanical aimers must be properly calibrated and used with the proper adapter recommended by the manufacturer. (The adapter setting will be embossed on the face of some lamps.)

3. Turn on headlamps and check all filaments-both high and low beam. Turn off headlamps before checking for adjustments. Do not turn on headlamps while mechanical aimers are attached to the headlamp.

4. All headlamps that are found not to be within the four-inch tolerance shall be adjusted to zero inches up or down and zero inches to the right or left.

E. Headlamps on vehicles used for snow removal. Approved auxiliary headlamps may be mounted above the conventional headlamps. (These lamps must be in compliance with this section in its entirety, subdivision 7 of 19 VAC 30-70-150, and subdivision 1 of 19 VAC 30-70-170.)

Inspect for and reject if:

1. Lamps are not approved type headlamps.
2. Lamps are not mounted in a manner which will permit proper aiming.
3. Lamps are mounted so as to obstruct the driver's vision.
4. The auxiliary headlamp circuit does not contain a switch which will deactivate the primary headlamp system when the auxiliary headlamps are in use.
5. Auxiliary headlamps are not aimed in accordance with the provisions of subdivision B 2 of this section.
6. Headlamps are not wired in accordance with the provisions of subdivision C 8 of this section.

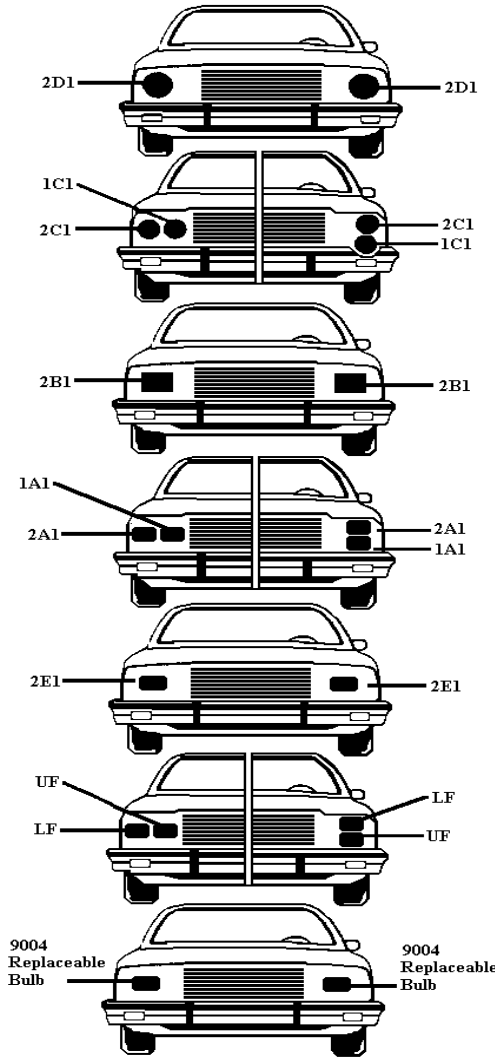

Locations of Type 1, Type2, LF/UF, and Replaceable Bulb Headlamps

NOTE: Always inspect the following sealed beam and replaceable bulb, and integral beam headlamps on LOW BEAM only;

- 5¾ inch, marked 2, 2C, or 2C1
- 7 inch, marked 2, 2D, or 2D1
- 100 x 165mm rectangular, marked 2A, 2A1, or 2E1, 2G1 or 2H1
- 200 x 142mm rectangular, marked 2B or 2B1
- Replaceable bulb headlamp, marked LF with 9004 (HB1)
- 92 x 160mm rectangular, marked LF
- Replaceable bulb headlamps with 9006 (HB4) alone or in combination with 9005 (HB3)
- 55 x 135mm rectangular, marked L

•Integral beam headlamp when high and low beam reflectors move together.

19 VAC 30-70-160. Auxiliary lamps: backup; cornering; driving; fog; spot and warning.

A. Auxiliary lamps on a vehicle consist of seven general types: backup lamps, cornering lamps, driving lamps, fog lamps with an amber or clear lens, spot lamps and warning lamps, and daytime running lamps.

B. School buses may be equipped with an eight-lamp warning system of two red and two amber warning lamps of an approved type on the front and rear of such vehicle.

1. School buses may also be equipped with roof mounted flashing white or amber warning lamps of an approved type.

2. In addition to required warning lamps, school buses may be equipped with a stop signal arm consisting of an octagonal sign which meets FMVSS specifications (Federal Motor Vehicle Safety Standards, 49 CFR 571 et seq.). The stop signal arm shall be reflectorized or be equipped with two red warning lamps of an approved type.

C. There is no limit on the number of backup lamps that a vehicle may have so long as they are of an approved type.

D. No more than four lamps, including two headlamps, may be lighted at any time to provide general illumination ahead of the vehicle.

E. Approved type blue or blue and red lights are permitted on any law-enforcement vehicle. Approved type red warning lights or red and white lights showing to the front are permitted on fire department vehicles, including publicly owned state forest warden vehicles, ambulances, any rescue vehicle used for emergency calls, animal warden vehicles, school buses and vehicles used by security personnel at the Newport News Shipbuilding and Drydock Company, Bassett-Walker, Incorporated, or the Tultex Corporation. No more than two flashing or steady-burning red lights or red and white combination lights of an approved type may be installed on one vehicle owned by any member of a fire company, volunteer fire company or volunteer rescue squad.

F. Vehicles mentioned in subsection E of this section permitted to be equipped with flashing, blinking or alternating red, red and white, blue, or blue and red emergency lights (except vehicles owned by any member of a fire company, volunteer fire company, volunteer rescue squad or any ambulance driver employed by a privately owned ambulance service) may be equipped with the means to flash their headlamps when their emergency warning lamps are activated provided:

1. The headlamps are wired to allow either the upper beam or lower beam to flash but not both; and
2. The headlamp system includes a switch or device which prevents flashing of headlamps when headlamps are required to be lighted pursuant to current statute.

Final Regulations

G. Any fire vehicle used exclusively for fire fighting, any ambulance or rescue or lifesaving vehicle used for the principal purpose of emergency relief or any wrecker used for the principal purpose of towing disabled vehicles may be equipped with clear auxiliary lamps which shall be used exclusively for lighting emergency scenes. Such lamps shall be of a type permitted by the superintendent. Any government-owned police vehicle may be equipped with clear auxiliary lamps of a type approved by the superintendent.

H. Approved type amber flashing, blinking or alternating lights are permitted on vehicles used for the principal purpose of towing or servicing disabled vehicles or in constructing, maintaining and repairing highways or utilities on or along public highways and vehicles used for the principal purpose of removing hazardous or polluting substances from the state waters or drainage areas on or along public highways. Such lamps are permitted on vehicles used for servicing automatic teller machines, refuse collection vehicles, hi-rail vehicles and on vehicles used for towing or escorting over-dimensional materials, equipment, boats, or manufactured housing units by authority of highway hauling permit.

1. Approved type amber flashing, blinking or alternating lights are permitted on fire apparatus, ambulances, and rescue and life-saving vehicles, provided the amber lights are mounted or installed on the rear of the vehicles.

2. Approved type amber flashing, blinking or alternating lights are permitted on vehicles owned and used by businesses providing security services and vehicles used to collect and deliver the United States mail, vehicles used by law enforcement personnel in the enforcement of laws governing motor vehicle parking, government owned law enforcement vehicles provided the lights are used for giving directional warning and vehicles used to provide escort for funeral processions.

3. An approved type amber flashing, blinking or alternating light may be mounted on the rear of any vehicle used to transport petroleum products. The light must be wired through the reverse gear circuit and activate in conjunction with the back-up lights and audible alarm.

I. Inspect for and reject if:

1. Vehicle has an auxiliary lamp being used for a purpose other than for which it was approved;

EXCEPTION: Any lighting device ~~mounted above the level of the regular headlamps~~ which is both covered and not illuminated, other than lamps required, shall not be considered for inspection. Fog and driving lamps mounted below the level of the regular headlamps must be checked for aim as outlined in subdivisions 1 10 i and 11 g of this section *if not covered*.

2. A vehicle has installed on it a warning lamp that is not of an approved type or has been altered.

Reject if the vehicle has wire, unapproved plastic covers, any other materials which are not original equipment or any colored material placed on or in front of any auxiliary lamps: backup, cornering, driving, fog, spot, or warning lamps.

3. Vehicle is equipped with a combination of auxiliary lamps which include more than two fog lamps, or more than two spot lamps, or more than two driving lamps. Reject a vehicle equipped with a headlamp mounted or used as an auxiliary lamp.

NOTE: Vehicles equipped, from the factory, with two driving lamps should not be rejected.

4. Vehicle is equipped with an auxiliary lamp that does not function properly. (If an auxiliary lamp has been modified by removing the wiring, bulb and socket, the unit will be considered an ornament and not a lamp and will not be considered in inspection.)

5. Vehicle is equipped with a lighted advertising sign. Except commercial motor vehicles, buses operated as public carriers, taxicabs, and privately-owned passenger cars used for home delivery of commercially prepared food. Commercial motor vehicles, buses operated as public carriers, and taxicabs may be equipped with vacant and destination signs and one steady burning white light for illumination of external advertising. Privately-owned passenger cars used for home delivery of commercially prepared food may be equipped with one steady burning white light for the nighttime illumination of a sign identifying the business delivering the food. Do not reject approved identification lights.

6. Any lamp is not of an approved type or if lamps to be burned together as a pair do not emit the same color light.

7. The lens has a piece broken from it. The lens may have one or more cracks provided an off-color light does not project through the crack or cracks.

8. Backup lamps are not required. However, if installed they must operate and be inspected.

Inspect for and reject if:

a. Lamps are not of an approved type or a lamp has been altered;

b. Wiring or electrical connections are defective;

c. The lens has a piece broken from it. The lens may have one or more cracks provided in off-color light does not project through the crack or cracks;

d. Lens is other than clear;

e. Lamps are not wired into the reverse gear or an independent circuit;

9. Cornering lamps are not required. However, if installed they must operate and be inspected.

Inspect for and reject if:

- a. Lamps are not of an approved type or a lamp has been altered;
- b. Wiring or electrical connections are defective;
- c. The lens has a piece broken from it. The lens may have one or more cracks provided an off-color light does not project through the crack or cracks;
- d. The color of the light is other than clear or amber;
- e. The lamps do not burn in conjunction with the turn signals;

10. Driving lamps are not required. However, if installed they must operate and be inspected.

Inspect for and reject if:

- a. Driving lamps are installed on vehicles equipped with the four headlamp system, except the "F" type headlamp system;
- b. A vehicle is equipped with more than two driving lamps;
- c. Driving lamps are not of an approved type or have been altered;
- d. The color of the lamp is other than white;
- e. The lens has a piece broken from it or is rotated away from its proper position. The lens may have one or more cracks provided an off-color light does not project through the crack or crack;
- f. Wiring or electrical connections are defective;
- g. Any driving lamp is mounted above the level of the regular headlamps, or is not mounted firmly to prevent excessive vibration;
- h. Driving lamps are not wired so that they will burn only when the high beams of the regular headlamps are activated;
- i. Driving lamps are not aimed so that the center of the hot spot drops three inches in 25 feet so that the hot spot is directly ahead of the lamp;

NOTE: Driving lamps must be aimed using the optical headlight aimer.

- j. A tolerance of four inches in 25 feet is allowed in both the horizontal and the vertical adjustment;

11. Fog lamps are not required. However, if installed they must operate and be inspected.

Inspect for and reject if:

- a. A vehicle is equipped with more than two fog lamps;
- b. Lamps are not of an approved type or a lamp has been altered;
- c. The lens is other than clear or amber. Fog lamps may have black-end bulbs or small metal caps over the end of the bulb;

- d. The lens has a piece broken from it or is rotated away from its proper position. The lens may have one or more cracks provided an off-color light does not project through the crack or crack;

- e. Wiring or electrical connections are defective;
- f. Any fog lamp is mounted above the level of the regular headlamps, or is not mounted firmly;
- g. Lamps are not wired and aimed according to the following instructions:

(1) Fog lamps are general illumination lamps as covered in subsection D of this section. They must burn through the tail light circuit even if on a separate switch. If installed on a vehicle with a four-headlamp system, or a vehicle equipped with driving lamps, they must be wired into the low beam circuit.

(2) Fog lamps must be aimed so that the top edge of the high intensity zone is set at the horizontal centerline and the left edge of the high intensity zone is set at the vertical centerline. (Same as low beam headlights.)

NOTE: Fog lamps must be aimed using the optical headlight aimer.

(3) A tolerance of four inches in 25 feet is allowed in both the horizontal and the vertical adjustment.

12. Spot lamps are not required. However, if installed they must operate and be inspected.

Inspect for and reject if:

- a. Vehicle is equipped with more than two spot lamps;
- b. Lamps are not of an approved type or a lamp has been altered;
- c. The lens in any spot lamp is other than clear;
- d. The lens has a piece broken from it or is rotated away from its proper position. The lens may have one or more cracks provided an off-color light does not project through the crack or crack;

- e. Wiring or electrical connections are defective;

13. Daytime Running Lamps (DRLs) are not required. However, if installed they must operate and be inspected. DRLs must be installed in pairs.

NOTE: DRLs may or may not be wired into the tail light circuit.

Inspect for and reject if:

- a. Any lamp, except headlamps, used as DRLs is not marked "DRL;"
- b. Fog lamps or parking lamps are used as DRLs;
- c. More than one pair of lamps are used and or designated as DRLs;

Final Regulations

- d. A DRL is mounted higher than 34 inches measured to the center of the lamp;
- e. The color is other than white to amber;
- f. DRLs do not deactivate when the headlamps are in any "on" position.

Any DRL optically combined with a turn signal or hazard lamp must deactivate when the turn signal or hazard lamp is activated and then reactivate when the turn signal or hazard lamp deactivates.

19 VAC 30-70-180. Clearance lamps and reflectors.

Inspect for and reject if:

1. Any motor vehicle, trailer, semitrailer or other vehicle is not equipped with clearance lamps if the vehicle is over 7 feet wide or if any portion extends 4 inches or more outside the front fender line.

NOTE: See 19 VAC 30-70-550 for vehicles exceeding 10,000 GVWR.

When a motor vehicle with a trailer attached is presented, the combination may be considered as one unit in meeting this requirement. If presented separately, the individual unit must meet these requirements.

2. Lamps and reflectors are not of an approved type or a lamp has been altered.

If the lamps or reflectors have unapproved plastic covers, any other materials which are not original equipment or any colored material placed on or in front of lamps or reflectors.

3. Lenses on lamps on the front are not yellow or amber and lenses on lamps on the rear are not red or if a lens has a piece broken from it. A lens may have one or more cracks provided an off-color light does not project through the crack or cracks.

4. Wiring or electrical connections are defective, all filaments do not burn.

5. Two amber lamps are not mounted on the front and two red lamps on the rear, so as to indicate the extreme width of the body, and as high on the permanent body as practical, except that approved 180 degree lamps with yellow or amber lens may be mounted on the side of the vehicle at or as near the front as possible, or if the front is not the widest portion, the lamps may be installed on the side and as near that point as possible. And with the further exception that 180 degree lamps with red lens may be mounted on the side of the vehicle at or as near the rear as possible or if the rear is not the widest portion of the vehicle, the lamps may be installed on the side as near that point as possible.

6. Any vehicle equipped with three red identification lamps with the lamp centers spaced not less than six inches or more than 12 inches apart and installed as close as practicable to the top of the vehicle and as close as practicable to the vertical centerline of the vehicle may have the rear dimension or marker lamps required by subdivision 5, mounted at any height but indicate as nearly as practicable the extreme width of the vehicle.

7. Other specially constructed vehicles may be equipped with the required clearance lamps not mounted on the extreme rear, provided such red lamps are clearly visible from the rear and provided further that two red reflectors of an approved type are mounted on the extreme rear. In unusual cases the rear lamp may be mounted on the cab and another red reflex reflector placed on the extreme rear.

8. In addition to the required clearance lamps showing to the front and to the rear, a vehicle may be equipped with clearance lamps on the side of the vehicle. When such an installation is used, all of the clearance lamps on the side except the one at or near the rear must have an amber lens. The clearance lamps on the side at or near the rear must have a red lens.

9. Any vehicle covered by subdivision 1, except school buses, is not equipped with amber reflectors on the sides as near the front as practical, and red reflectors on the rear. The reflectors must be at least 24 15 inches and not more than 60 inches from the ground. No reflector can have a piece broken from its reflective surface, but may have one or more cracks.

10. Any combination of vehicles whose actual length exceeds 35 feet if the vehicles are not wide enough to have clearance lights, if the vehicle is not equipped with reflex reflectors of a type approved by the superintendent and mounted on the widest part of the towed vehicle so as to be visible from the front and sides of the vehicle. No reflector can have a piece broken from its reflective surface, but may have one or more cracks.

11. Any passenger vehicle is equipped with clearance lamps, unless such lamps are used to mark the extreme width of the vehicle or used as taxicab identification, or used as supplemental turn signals. (See 19 VAC 30-70-190, ~~subsection B.~~)

12. Vehicles so constructed as to make compliance with the requirements of 19 VAC 30-70-180, subdivisions 1, 5, 7, 9 and 10 impractical will be equipped with clearance lamps and reflectors at the most practical location to provide maximum visibility.

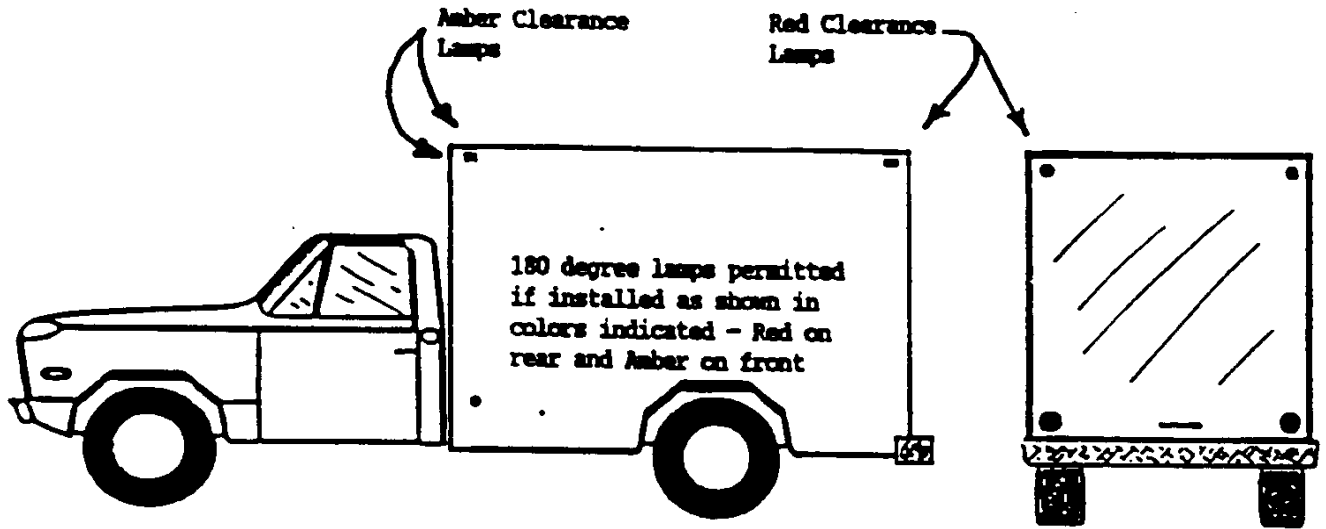

If equipped with three red identification lamps, the required clearance lamps may be mounted at any height so long as they indicate, as nearly as practicable, the extreme width of the vehicle. See NOTE.

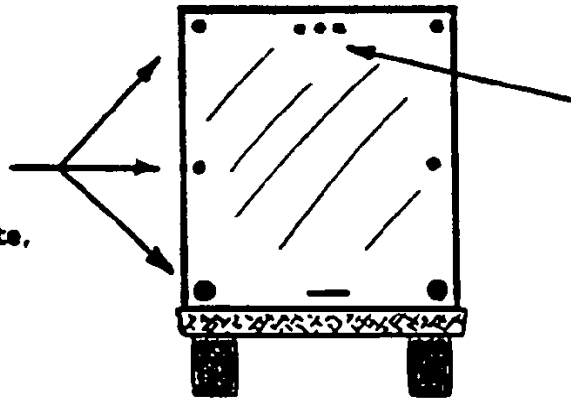

NOTE: Must be equipped with three red identification lamps.

ILLUSTRATIONS FOR PROPER INSTALLATION OF REFLECTORS

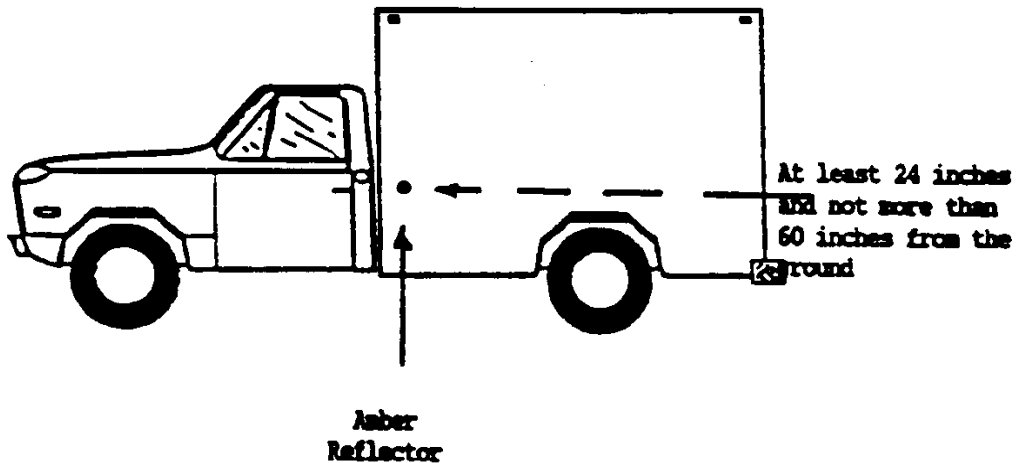

Final Regulations

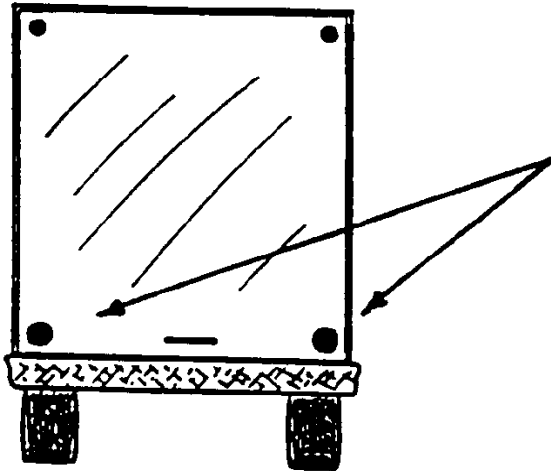

Red ————— At least 24 inches and not more
Reflectors than 60 inches from the ground

19 VAC 30-70-200. Permissible lighting equipment.

A. Any vehicle may be equipped with:

- ~~1. Magneto or acetylene lighting, if original equipment and if otherwise in conformity with these rules and regulations and Virginia statutes;~~
- ~~2.~~ 1. Running board or courtesy lamps, of not over six candlepower;
- ~~3.~~ 2. Vacant or destination signs, if a taxicab or bus;
- ~~4.~~ 3. Identification lamps of approved type;
- ~~5.~~ Front fender clearance jewels, if amber or yellow;
- ~~6.~~ 4. Interior lights, not more than 15 candlepower;

Exception: This does not apply to alternating, blinking or flashing colored emergency lights mounted inside law enforcement vehicles or flashing shielded red or red and white lights, mounted inside vehicles owned by members of volunteer fire companies, volunteer rescue squads or owned or used by professional firefighters.

- ~~7.~~ 5. Hood ornament light if of a type approved or permitted by the superintendent;
- ~~8.~~ 6. Any approved lamp in good working order when used for the purpose for which it was approved;

B. Side Marker Lamps-Side marker lamps are not required. If installed they must operate and be inspected. If the bulb, socket and wiring are removed from an individual lamp unit, the unit will not be considered during inspection.

C. Inspect for and reject if:

1. Lamps are not of an approved type, or do not comply with subdivision 1 of this section;
2. Lamps are not installed on the permanent structure of the vehicle with one as far to the rear and one as far forward as practicable and at a location which is not less than 15 inches above the road surface when measured from the center of the lamp;

3. Lamps installed on the side to the rear do not project a red light and lamps installed on the front do not project an amber light;

4. Lens has a piece broken from it. The lens may have one or more cracks provided no off-color light projects through the crack or cracks;

5. Any vehicle has unapproved lens or plastic covers, any other materials which are not original equipment or any colored material placed on or in front of permissible lighting equipment;

6. Wiring or electrical connections are defective or filaments do not burn.

19 VAC 30-70-440. Service brakes.

A. The inspector, as a minimum must drive all vehicles into the inspection lane and test both service and parking brakes, except vehicles the inspector is not qualified to drive. In these cases, the inspector will ride in the vehicle and observe the application of the brakes.

B. A minimum of one wheel or one wheel and drum or dust cover must be removed from each vehicle at the time of inspection except:

1. Vehicles having open brake mechanisms which will permit the inspection of the brake lining, or discs and disc pads, without removing the wheel and rim.

WARNING: Failure to properly torque lug nuts may cause severe damage to the wheel.

2. The inspection receipt (approval and rejection) shall be marked to reflect which wheel and drum or dust cover was removed or inspected.

C. If any braking problem is detected, the inspector may test drive or require a test drive of the vehicle and use the decelerometer as necessary. If the decelerometer is used and the vehicle does not meet the minimum standards for stopping distances, as shown in paragraph F, the vehicle should be rejected.

D. Inspect for and reject if:

1. Vehicles equipped with air brakes: when the air brake adjustment on vehicles is equal to or exceeds Table #1 for cam brakes or brake shoe travel is greater than 1/16" on wedge brakes when measured according to Illustrations #1 and #2. (See Procedure in addition to illustrations.)

**TABLE 1
MINIMUM CRITERIA FOR BRAKE ADJUSTMENT**

Brake adjustment shall not exceed those specifications contained in the following tables relating to maximum stroke at which brakes should be re-adjusted.

(Dimensions in Inches)

Effective Area (Sq. In.)	Outside Diameter	Maximum Stroke	Maximum Stroke With Brakes Adjusted	Maximum Stroke at Which Brakes Should be Readjusted
BOLT TYPE BRAKE CHAMBER DATA				
12	6 15/16	1 3/4	Should be as short as possible without brakes dragging	1 3/8
24	9 3/16	2 1/4		1 3/4
16	8 1/16	2 1/4		1 3/4
6	5 1/4	1 5/8		1 1/4
9	6 3/15	1 3/4		1 3/8
36	11	3		2 1/4
30	9 7/8	2 1/4		2
ROTOCHAMBER DATA				
9	4 9/32	2	Should be as short as possible without brakes dragging	1 1/2
12	4 13/16	2		1 1/2
16	5 13/32	2 1/2		1 7/8
20	5 15/16	2 1/2		1 7/8
24	6 13/32	2 1/2		1 7/8
30	7 1/16	3		2 1/4
36	7 5/8	3 1/2		2 5/8
50	8 7/8	4		3
CLAMP TYPE BRAKE CHAMBER DATA				
6	4 1/2	1 5/8	Should be as short as possible without brakes dragging	1 1/4
9	5 1/4	1 3/4		1 3/8
12	5 11/16	1 3/4		1 3/8
16	6 5/8	2 1/4		1 3/4
20	6 25/32	2 1/4		1 3/4
24	7 7/32	2 1/4		1 3/4
30	8 3/32	2 1/2		2
36	9	3		2 1/4
WEDGE BRAKE DATA				
Movement of the scribe mark on the lining shall not exceed 1/16 inch; and failure of the brake shoes to move shall constitute a violation.				

AIR DISC BRAKES - PUSH ROD LIMITS BRAKE ADJUSTMENT RECOMMENDATIONS			
Chamber Size	Stroke (In Inches) at Initial Adjustment		Maximum Stroke (In Inches) Before Readjustment
12	1 3/8		1 5/8
16	1 1/2		1 7/8
20	1 5/8		2
24	1 3/4		2 1/8
30	1 7/8		2 1/4
BENDIX WESTINGHOUSE			
DD2			2
DD3			2

Dimensions listed do not include capscrew head projections for rotochambers and bolt clamp projections for clamp-type brake chambers.

PROCEDURE FOR MEASURING CAM AND WEDGE BRAKES

- On vehicles equipped with Cam brakes, mark each brake chamber push rod at the face of the brake chamber with the brakes released. Apply the air brakes fully, minimum air pressure of 90 to 100 psi, and measure the distance the push rod travels from the face of the chamber to the mark previously made when the brakes were released. This measurement is the push-rod stroke (see Table).

- On vehicles equipped with wedge brakes, remove the inspection hole cover at each dust shield and with the brakes released, scribe a line on the edge of the brake lining. Apply the air brakes fully and measure the distance the brake lining travels.

Final Regulations

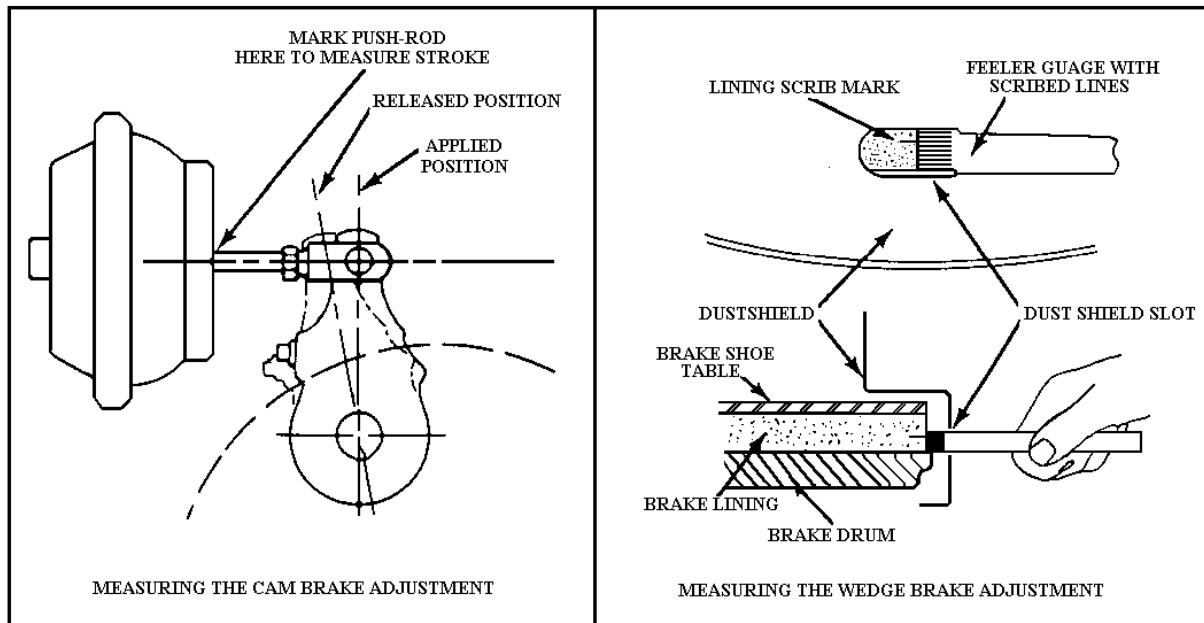

2. *Brake hose and tubing.* There is any leakage in any hydraulic, air or vacuum lines; hoses have any cracks, crimps, restrictions, or are abraded exposing fabric into second ply of fabric; tubing or connections leak, are crimped, restricted, cracked, or broken; ~~any valves leak or are inoperative.~~

- a. *Hose with any damage extending through the reinforcement ply. Rubber impregnated fabric cover is not a reinforcement ply. Thermoplastic nylon may have braid reinforcement or color difference between cover and inner tube. Exposure of second color is cause for rejection.*
- b. *Bulge or swelling when air pressure is applied.*
- c. *Two hoses improperly joined (such as a splice made by sliding the hose ends over a piece of tubing and clamping the hose to the tube).*

3. *Service brakes.* There is less than 1/5 reserve in pedal travel of the service brake when fully applied on all hydraulic, mechanical, or power-assisted hydraulic braking systems.

4. When tested on dry, hard, approximately level road free from loose material, at a speed of 20 miles per hour without leaving a 12-foot wide lane, a ~~brake machine or decelerometer reading distance~~ in excess of the following stopping distance is obtained: ~~(When in doubt about a vehicle's stopping ability, the inspector shall conduct or observe a road test.)~~

Any bus, truck or tractor—40 feet;

All combinations of vehicles—40 feet.

5. Every motor vehicle, trailer or semitrailer which is not equipped with operational brakes on all wheels (except

as shown in a, below), or any brake has been disconnected or rendered inoperative or improperly installed.

- a. Road tractors, tractor trucks, or trucks if manufactured prior to July 25, 1980, having three or more axles are not required to have brakes on the steering axle; however, if installed must be inspected and meet all requirements of this section.
- b. *Missing, bent or broken mechanical components including: shoes, lining pads, spring, anchor pin, spiders, cam rollers, push rods and air chamber mounting bolts, air reservoirs not securely mounted or leaks.*
- c. *Absence of braking action on any axle required to have brakes, upon application of the service brakes (such as missing brakes or brake shoes, failing to move upon application of a wedge, S-cam or disc brake).*
- d. *Loose brake components including air chambers, spiders and cam shaft support brackets.*
- e. *Audible air leak at brake chamber (example: ruptured diaphragm, loose chamber clamp, etc.)*

Brake Linings and Disc Pads:

6. ~~Rivets or bolts are loose or missing.~~
7. ~~Lining or pad broken or cracked so that pad or lining or parts of pad or lining are not firmly attached to the shoe or has cracks on the friction surface extending to the open edge.~~
6. *Linings or pads are broken or cracked so that brake pad is not firmly attached to the shoe or improperly*

installed or, cracks on the friction surface extends to the open edge.

a. Rivets or bolts are loose or missing

~~8- b.~~ Lining or pad friction surface is saturated with oil, grease or brake fluid.

~~9.~~ Thickness of bonded lining or pad is less than 3/16 of an inch at the thinnest point.

~~10. Brake linings and pads (riveted only).~~

a. Air brakes - All axles except steering.

(1) ~~9/32 of an inch or less, measured at center of shoe or to wear indicators, if so equipped.~~

(2) ~~Steering axle - 6/32 of an inch or less, measured at center of shoe, or to wear indicators, if so equipped.~~

b. Hydraulic and electric.

(1) ~~All axles except steering - 6/32 of an inch or less, measured at center of shoe, or to wear indicators, if so equipped.~~

(2) ~~Steering axle - 4/32 of an inch or less, measured at center of shoe, or to wear indicators, if so equipped.~~

~~11. Thickness of bolted lining is less than 5/16 of an inch measured at the shoe center.~~

~~E. On School Buses Only. INSPECT FOR AND REJECT IF:~~

~~1. Thickness of bonded lining or pad is less than 2/32 of an inch at the thinnest point.~~

~~7. Nonsteering axles. Lining with a thickness less than 1/4 inch at the shoe center for air drum brakes. 1/16 inch or less at the shoe center for hydraulic and electric drum brakes and less than 1/8 inch for air disc brakes, lining with a thickness less than 3/16 inch for a shoe with a continuous strip of lining or to wear indicators if so equipped.~~

a. Steering axles. Lining with thickness less than 1/4 inch at the shoe center from drum brakes, less than 1/8 inch for air disc brakes and 1/16 inch or less for hydraulic disc and electric brakes, lining with a thickness less than 3/16 inch for a shoe with a continuous strip of lining or to wear indicators if so equipped.

b. Mismatch across any power unit steering axle of:

(1) Air chamber sizes.

(2) Slack adjuster length.

~~2- 8.~~ Thickness of riveted or bolted lining is less than 2/32 of an inch above the rivet or bolt head(s).

~~3- 9.~~ Any lining or pad is misaligned or does not make full contact with the drum or rotor.

Brake Drums and Discs:

~~4. 10.~~ Brake drums or brake discs (rotors) are worn or scored to the extent that their remachining would ~~exceed~~ result in a failure to meet manufacturer's specifications.

~~5- 11.~~ Brake drums or discs with any external crack or cracks ~~more than 1/2 the width of the friction surface of the drum or disc that open upon brake application.~~

NOTE: Do not confuse short hairline heat cracks with flexural cracks.

Mechanical Linkage:

~~6. Cables are frayed or frozen.~~

~~7. Mechanical parts missing, broken, badly worn, or misaligned.~~

~~12. Any portion of the drum or rotor missing or in danger of falling away.~~

Hydraulic:

NOTE: Some motor vehicles, beginning with 1976 models, have a hydraulic power system that serves both the power assisted brakes and power assisted steering system. Some vehicles, beginning with 1985 models, have an integrated hydraulic actuation and anti-lock brake unit using only brake fluid.

Hydraulic System Operation:

~~8- 13.~~ Stop engine, then depress brake pedal several times to eliminate all pressure. Depress pedal with a light foot-force (30 pounds). While maintaining this force on the pedal, start engine and observe if pedal moves slightly when engine starts.

Reject vehicle if pedal does not move slightly as engine is started while force is on brake pedal.

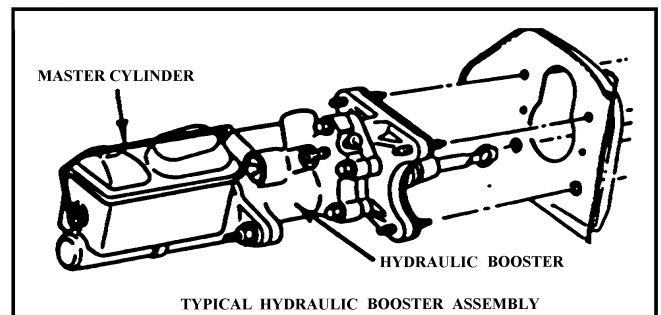

Condition of Hydraulic Booster Power Brake System:

~~9- 14.~~ Inspect system for fluid level and leaks. Reject vehicle if there is insufficient fluid in the power steering pump reservoir; if there are broken, kinked or restricted fluid lines or hoses; if there is any leakage of fluid at the pump, steering gear or brake booster, or any of the lines or hoses in the system; or if belts are frayed, cracked or excessively worn.

Integrated Hydraulic Booster/Anti-Lock System Operation:

Final Regulations

40- 15. With the ignition key in the off position, depress brake pedal a minimum of 25 times to deplete all residual stored pressure in the accumulator. Depress pedal with a light foot- force (25 lbs.). Place ignition key in the on position and allow 60 seconds for the brake warning light to go out and the electric pump to shut off.

Reject vehicle if the brake pedal does not move down slightly as the pump builds pressure or if the brake and anti-lock warning lights remain on longer than 60 seconds.

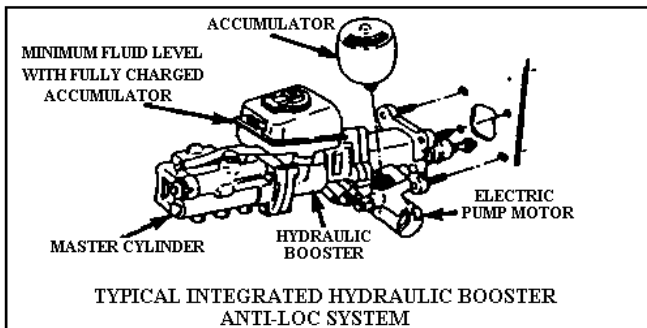

Condition of Integrated Hydraulic Booster/Anti-Lock System with Electronic Pump:

44- 16. With the system fully charged, inspect system for fluid level and leaks.

Reject vehicle if there is insufficient fluid in the reservoir; if there are broken, kinked or restricted fluid lines or hoses; or if there is any leakage of fluid at the pump or brake booster, or any of the lines or hoses in the system.

Vacuum System Operation:

42- 17. Stop engine then depress brake pedal several times to eliminate all vacuum in the system. Depress pedal with a light foot-force (25 lbs.). While maintaining this force on the pedal, start engine and observe if pedal moves down slightly when engine starts.

Reject vehicle if pedal does not move down slightly as engine is started while force is on the brake pedal. In full vacuum-equipped vehicles, there is insufficient vacuum reserve for one full service brake application after engine is stopped.

- a. Has insufficient vacuum reserve to permit one full brake application after engine is shut off.
- b. Lacks an operative low-vacuum warning device as required.

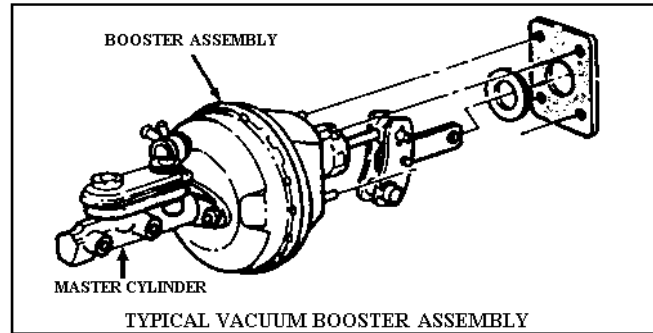

Condition of Vacuum Booster Power Brake System:

43- 18. Visual inspection. Reject vehicle if there are collapsed, cracked, broken, badly chafed or improperly supported hoses and tubes, loose or broken hose clamps.

44- 19. There is any leakage in the hydraulic system. (Do not disturb the dust boot when checking for leaking wheel cylinders.)

45- 20. Fluid level in master cylinder is below the proper level for the particular vehicle.

46- 21. There is any evidence of a caliper sticking or binding.

~~Vacuum System and Air Brake System Brakes:~~

~~17- Brakes on tractor or truck will not release.~~

~~18- Air cleaners clogged sufficiently to prevent proper intake of air.~~

~~19- Piston packings, valves, diaphragms, piston cups or fittings leaking.~~

~~20- Trailer brake chamber rods do not follow application of tractor brake pedal, or do not reach full released position.~~

~~21- Time required to build up air pressure from 50 to 90 pounds per square inch (PSI) is more than 5 minutes with engine running at fast idle.~~

22. Motor vehicle is equipped with air brakes and does not have an operating air pressure gauge.

~~23- The low air warning device connected on the low pressure indicator of the air brake system does not operate when air pressure is lowered to a range of 50 to 70 PSI. The vehicle is not equipped with a low air warning device or if device has been rendered inoperative.~~

23. Any bus, truck, road tractor and tractor truck manufactured after ~~February 28, 1975~~ *March 15, 1975*, must have a visible low air warning device. Those manufactured on or before ~~February 28, 1975~~ *March 15, 1975*, may have either an audible or visible low air warning device.

a. ~~Low pressure warning device missing, inoperative or does not operate at 55 psi and below or 1/2 the governor cut out pressure whichever is less.~~

~~24. Governor cut-in pressure is lower than 80 PSI or cut-out pressure higher than 125 PSI, unless other values are specified by the manufacturer.~~

~~25. 24. Compressed air reserve is not sufficient to make one full service brake application after engine is stopped, or with system fully charged, the reservoir pressure is lowered more than 20 30% by one full brake application.~~

a. ~~Brake chamber push rods do not follow application of service brake pedal, or do not reach full released position (example: defective return spring).~~

~~26. Air brake leakage rate with engine stopped and service brakes released in one to five minutes exceeds:~~

~~2 PSI/per minute for single vehicles~~

~~3 PSI/per minute for combination of vehicles (additional 2 PSI/per minute drop allowed for each additional towed vehicle).~~

~~NOTE: It will be necessary to record the pressure over a time interval corresponding to the test gauge increments for accuracy.~~

~~27. Air brake leakage rate with engine stopped and service brakes fully applied in one minute exceeds:~~

~~3 PSI for single vehicles~~

~~4 PSI for combination of vehicles (additional 2 PSI is allowed for each additional towed vehicle).~~

~~28. Air reservoirs not securely mounted or leaks.~~

~~29. Brake chambers, relay devices, and other valves are not securely attached.~~

~~30. Slack adjusters and actuators (push rods) are bent, broken, or have missing parts.~~

~~31. Air safety relief valve is defective or inoperative.~~

~~32. Compressor belt does not have sufficient tension or is worn or frayed. Compressor mounting has loose, broken or missing bolts or other attaching parts.~~

~~33. Air hoses, glad hands or gaskets are missing, broken or worn so as to allow any air leakage. Flexible air hoses are worn or damaged through the outer casing and into the second ply. Any bulging in air hose is observed when air pressure is in line. Any hose is cracked, broken or crimped. Hoses are not secured against chafing, binding or other mechanical damage. Hoses are not installed in a manner that prevents them from coming in contact with vehicle's exhaust system.~~

~~34. 25. Any bus, truck, road tractor, or tractor truck manufactured after February 28, 1975, if equipped with a manually operated device to reduce or remove the braking effort upon its front wheels.~~

~~Electric Brake System Brakes:~~

~~35. 26. Trailers show an amperage value more than 20% above or 30% below the brake manufacturer's maximum current rating for each brake.~~

~~36. 27. Ammeter shows no reading or indicator is not steady on application and release of brake controller.~~

~~37. 28. Any terminal connections are loose or dirty; wires are broken, frayed or unsupported; any single conductor or nonstranded wire or wires below size recommended by brake manufacturers are installed.~~

~~38. 29. Electrical trailer brakes do not apply automatically when breakaway safety switch is operated.~~

~~30. Absence of braking action on any wheel required to have brakes.~~

~~31. Missing or inoperative breakaway braking device(s).~~

~~Air Compressor:~~

~~32. Compressor drive belts in condition of impending or probable failure.~~

~~33. Loose compressor mounting bolts or compressor leaks.~~

~~34. Cracked, broken or loose pulley.~~

~~35. Tractor protection valve(s) is defective or inoperative.~~

~~36. Air safety relief valve is defective or inoperative.~~

19 VAC 30-70-450. Brakes.

A. Some vehicles are equipped with an actual emergency brake, while others have only a parking or holding brake. Some types may be actuated by a foot or hand lever, while others may incorporate a switch or valve to actuate the brake. Air and vacuum brake systems may employ spring activating parking brakes.

B. Inspect for and reject if:

1. Vehicle or combination of vehicles is not equipped with a parking, holding, or emergency brake in good working order of the type installed as original standard factory equipment for the vehicle on which it is installed.

2. The parking brake actuating mechanism does not fully release when the control is operated to the off position.

3. Any mechanical parts are missing, broken, badly worn, or are inoperative.

4. Cables are stretched, worn, or frayed or not operating freely.

5. Parking brake will not hold the vehicle stationary with the engine running at slightly accelerated speed with shift lever in drive position for automatic transmission or shift lever in low gear with clutch engaged for standard shift transmission.

Final Regulations

6. On vehicles equipped with automatic transmissions, the vehicle will start in any gear other than (P) park or (N) neutral.

7. *Any nonmanufactured hole(s) in the spring brake housing section of a parking brake.*

8. *All commercial motor vehicles manufactured after March 7, 1990, shall be equipped with a parking brake system adequate to hold the vehicle or combination under any condition of loading except agricultural commodity trailers, converter dollies, heavy haulers and pulpwood trailers.*

19 VAC 30-70-460. Brakes: trailer (GVWR 10,000 pounds or more).

A. All trailers and semitrailers registered for or having an actual gross weight of 10,000 pounds or more shall be equipped with operational brakes acting on all wheels.

B. Inspect for and reject if:

1. Trailer brakes do not comply with provisions of 19 VAC 30-70-430 and 19 VAC 30-70-440 *and* 19 VAC 30-70-450.

2. Operator does not have full control over brakes.

3. Combination will not stop as required in ~~19 VAC 30-70-430~~ 19 VAC 30-70-440 D 4.

4. ~~All Trailers, manufactured or assembled after January 1, 1964~~ are not equipped with emergency breakaway brakes designed to:

- a. Apply automatically upon breakaway from towing vehicle.
- b. Remain fully applied for at least 15 minutes.
- c. Apply and release by operation of the manual emergency control.
- d. Apply automatically when the pressure in the towing vehicle reservoir is reduced to a point between 45 and 20 PSI by a series of foot applications, when equipped with air brakes.

5. A minimum of one wheel must be removed from each axle equipped with brakes to inspect the brake components.

Exceptions:

- a. Wheels on trailers equipped with open brake mechanisms are not required to be removed.
- b. The inspection receipt shall be marked to reflect on which side the wheel or wheels were pulled or inspected.

19 VAC 30-70-470. Steering.

A. This system requires moving components to be checked for steering wheel lash, loose parts or binding. To properly inspect the power steering components, the engine must be running.

B. Inspect for and reject if:

1. Play at any point in the steering mechanism is excessive. The steering mechanism is unusually tight and binding when turning the steering wheel completely to the right and left. The steering mechanism will not turn in both directions, stop to stop, or steering stops have been removed. On certain model passenger buses, it may be necessary to open the inspection access door to allow visual inspection of the steering shaft universal joints.

2. Power steering is defective and affects adequate steering of the vehicle or fluid level in reservoir is below operating level. Belts do not have sufficient tension or are worn, frayed, or missing. Damage to hoses or leaks in hoses or fittings.

3. Any modification has been made to any part of the steering system that affects proper steering. A repair kit or preventive maintenance kit has been installed on a tie rod end, idler arm, ball joint, or any other part of the vehicle's steering gear.

NOTE: The repair kit or preventive maintenance kit usually consists of a small spring and a plastic cap which is placed over the bolt stud of the component and held in place by a retaining nut. There is nothing in this paragraph which prohibits the replacement of parts or components of a motor vehicle's steering gear in order to correct deficiencies in the steering gear.

4. Steering Lash/Travel-Trucks.

a. Before inspection the vehicle must be placed on a smooth, dry, level surface. For vehicles equipped with power steering, the engine must be running and the fluid level, belt tension and condition must be adequate before testing.

b. With road wheels in straight ahead position, turn steering wheel until motion can be detected at the front road wheels. Align a reference mark on steering wheel with a mark on a ruler and slowly turn steering wheel in the opposite direction until motion can be detected at the front road wheel. Measure lash at steering wheel. Special lash-checking instruments are also available, measuring free play in inches or degrees. Such instruments should always be mounted and used according to the manufacturer's instructions. With vehicle raised, visually inspect steering linkage, ball studs, tie rod end socket assemblies and all pivot points.

NOTE: On vehicles with power steering, engine must be running.

c. Reject vehicle if steering wheel movement exceeds:

Steering Wheel Size and Lash

Power Steering		Manual Steering	
16 in. or less	- 4½ in.(11.5cm)	16 in. or less	- 2 in. (5.1cm)
18 in.	- 4¾ in.(12.0cm)	18 in.	- 2¼ in.(5.4cm)
20 in.	- 5¼ in.(13.5cm)	20 in.	- 2½ in.(6.4cm)
22 in.	- 5¾ in.(14.5cm)	22 in.	- 2¾ in.(7.0cm)

d. Reject vehicle if visual inspection reveals excessive wear and/or looseness in any ball stud, end assembly, pivot point or mechanical linkage.

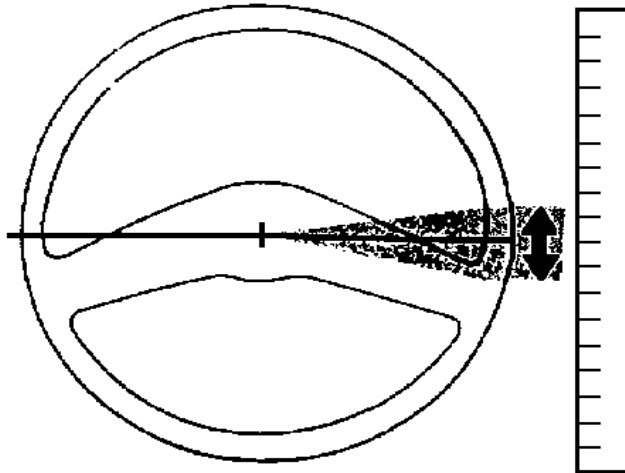

STEERING LASH

5. Any modification or replacement has been made to the steering wheel which affects proper steering. It shall be rejected if it is of a smaller size than the original factory equipment.

6. Steering column has any missing or loose bolts or positioning parts, resulting in motion of the steering column from its normal position. Steering shaft universal joints are loose or exhibit any abnormal movement when shaft is rotated. *Any welded repairs are made to the steering system, steering column, steering gear box, pitman arm or universal joints.*

a. *Any movement of a steering nut under steering load.*

7. Any missing or loose bolts or other parts resulting in motion of the steering gear box at the point of attachment to the vehicle's frame.

8. Any looseness or up and down movement of the pitman arm or on the steering gear box, output shaft or gear box.

9. Any control arm bushing is missing.

10. *Any vehicle equipped with an idler arm shows excessive looseness.*

11. *Any motion, other than rotational, between any linkage member and its attachment point of more than ¼ inch measured with hand pressure only.*

12. *Loose clamps, clamp bolts on tie rod ends or drag links.*

13. *Any looseness in any threaded joint.*

14. *Loose or missing nut on tie rods, pitman arm, drag link, steering arm or tie rod ends.*

15. Wheel Bearings/Steering Linkage.

a. With the front end of vehicle lifted properly, push pads away from rotor on disc brakes, and grab front tire at top and bottom, rock vigorously in and out and record movement. Wheel bearing looseness is detected by the relative movement between the brake drum or disc and the backing plate or splash shield.

(1) Reject vehicle if relative movement between drum and backing plate (disc and splash shield) is more than ¼ inch measured at the outer circumference of the tire for vehicles more than 10,000 pounds GVWR.

(2) Reject vehicle if any wheel bearing is excessively worn or not properly adjusted; any cotter key or other locking device is missing or inoperative.

b. Steering Linkage Play. First eliminate all wheel bearing movement by applying service brake. With vehicle lifted as shown below and wheels in straight ahead position, grasp front and rear of tire and attempt to move assembly right and left without moving the steering gear.

Reject vehicle if measured movement at front or rear of tire is greater than:

Wheel size: 16 inches or less - ¼ inch

17 to 18 inches - ⅜ inch

over 18 inches - ½ inch

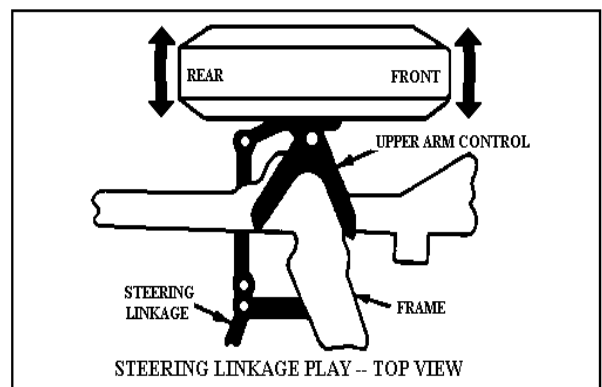

c. Kingpin Play. If vehicle is equipped with kingpins, first eliminate all wheel bearing movement by applying service brake. With front end lifted as illustrated for inspecting wheel bearings, (Figure C) grasp the tire at the top and bottom and attempt to move in and out to detect looseness. Measure the movement at the top or bottom of the tire at the outer circumference.

Final Regulations

Reject vehicle if measured movement at top or bottom of tire is greater than:

Wheel size: 16 inches or less - ¼ inch

17 to 18 inches - ⅜ inch

over 18 inches - ½ inch

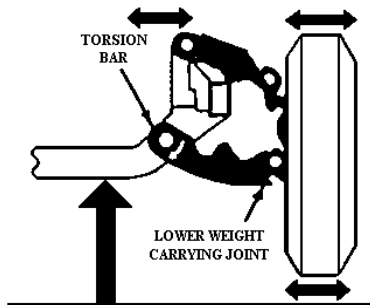

FIGURE A

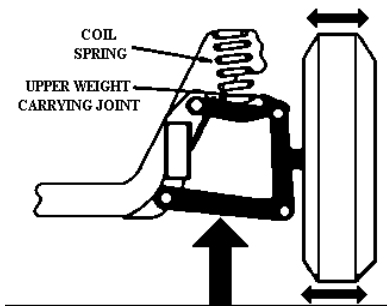

FIGURE B

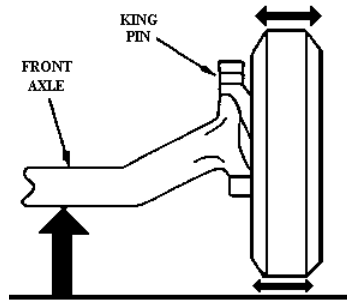
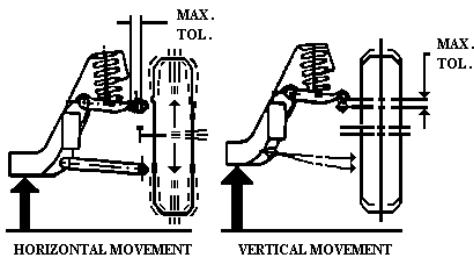

FIGURE C

11. Any vehicle equipped with an idler arm showing excessive looseness.

12. 16. Ball Joint Wear: There is a trend among U.S. automobile manufacturers toward the use of "wear-indicating" ball joints on light trucks. Many vehicles on the road, however, do not have wear-indicating ball joints. The inspection of both types will be discussed.

Figures 1, 2, 3 and 4 below illustrate the proper hoisting for checking ball joints.



SPRING ON UPPER CONTROL ARM

FIGURE 1

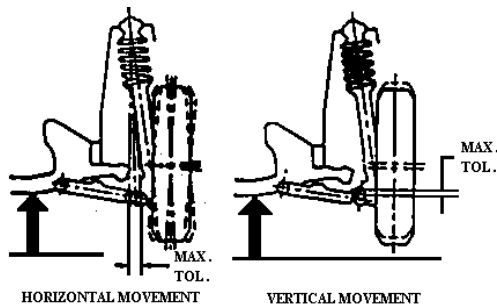

MACPHERSON STRUT

FIGURE 2

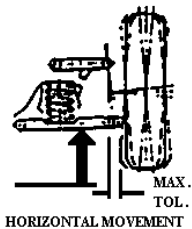

HORIZONTAL MOVEMENT

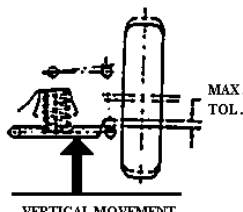

VERTICAL MOVEMENT

FIGURE 3

SPRING OR TORSION BAR ON LOWER CONTROL ARM
RAISING POSITIONS FOR SUSPENSION SYSTEMS

FIGURE 4

a. NOTE: To check ball joint wear on vehicles when the spring is supported on the upper control arm or when the spring is a part of a MacPherson strut or wear in any other type suspension not using ball joints when the front wheels are suspended on a solid axle, the vehicle must be hoisted as shown in Figure 1 or 2.

b. NOTE: Upper control arm must be stabilized in normal load carrying position by means of an upper control or other support tool to insure ball joint is in unloaded position.

c. NOTE: To check ball joint wear on vehicles not listed in above referred to section and diagram or tables when the spring is supported on the lower control arm; and to check the kingpin wear in any other type suspension not previously described when the wheels are independently suspended, the vehicle must be hoisted as shown in Figure 3 or 4.

~~13.~~ 17. Vehicles Without Wear Indicator Ball Joint.

a. Reject vehicle if there is noticeable play in the lower ball joint when hoisted as in Figures 1 or 2, or in the upper ball joint when hoisted as in Figures 3 or 4.

b. Reject vehicle if there is lateral movement in either front wheel in excess of 1/4 inch measured at the outside of the tire up to and including a 16-inch wheel; or in excess of 3/8 inch when the wheel is over 16 inches. This check must be made by grasping the tire at the extreme top and bottom and moving the wheel laterally across the surface. If play is noted, accurate measurement must be made by using the block test or with an accurate measuring device. No rejection should be made unless the specified tolerances are exceeded.

44. 18. Ball Joints With Wear Indicators (Trucks): Support vehicle with ball joints loaded (in normal driving attitude). Wipe grease fitting and checking surface free of dirt and grease. Determine if checking surface extends beyond the surface of the ball joint cover.

a. Reject vehicle if checking surface is flush with or inside the cover surface.

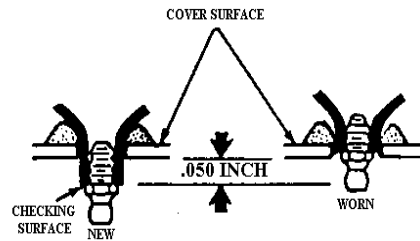
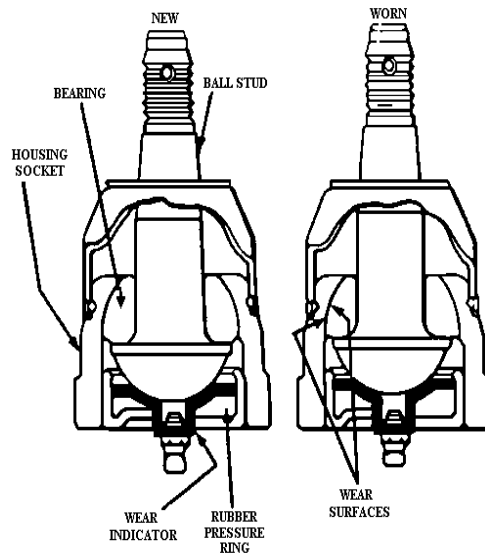

BALL JOINT WEAR INDICATOR

Wear is indicated by the protusion of the 1/2" diameter boss, (exaggerated for illustration) into which the grease fitting is threaded for greasable ball joints. This same boss exists and should be used to indicate wear in non-greasable ball joints. This round boss projects .050" beyond the surface of the ball joint cover on a new, unworn joint.

To inspect for wear, support vehicle by wheels so that the lower ball joints are in a loaded condition. Wipe the grease fitting or boss free of dirt and grease. Observe or scrape a scale, screwdriver or fingernail across the cover. If the grease fitting boss is flush or inside the cover surface, reject vehicle.

~~15.~~ 19. Any vehicle inspected in accordance with the recommendation of the manufacturer of such vehicle and found to be within the specification contained in the attached chart in subdivision 12 shall be deemed to meet inspection regulations.

Final Regulations

TABLE 1 MANUFACTURER'S TOLERANCE FOR BALL JOINT WEAR WITH SPRING OR TORSION BAR ON LOWER ARM

Model	Year	Vertical Movement	Horizontal Movement
CHEVROLET			
10, 20, 30	60-84	.094"	.250"
S-Series	82-84	Wear Ind.	(a)
GMC			
1500, 2500, 3500	60-84	.094"	.250"
S-Series	82-84	Wear Ind.	(a) .250"
DODGE			
B1, B2, B3, D1, D2, D3, D15, D25, D35, W2, W3, W15, W25, W35, RD2, WM3, MB3, CB3, AD1, AW1, Ramcharger	71-84	.020"(b)	(a)
Rampage	82-84	.000	.000
PLYMOUTH			
PB1, PB2, PB3, PD1, PW1, Trail Duster	74-84	.020"(b)	(a)
INTERNATIONAL			
100, 150, 200	74-80	.095"	(a)

(a) Do not test ball joints by Horizontal Movement.

(b) Preloaded by rubber or springs.

19 VAC 30-70-480. Suspension.

Inspect for and reject if:

1. Any positioning parts are cracked, broken, loose, or missing resulting in shifting of an axle from its normal position.
2. Any part of the torsion bar assembly or torque arm or any part used for attaching the same to the vehicle frame or axle which is cracked, broken or missing.

NOTE: This does not apply to loose bushing(s) in torque or track arms.

3. Vehicles designed for shock absorbers or cross stabilizer links, if any are missing, disconnected, broken, bent, loose or do not function properly.
4. Any leaf spring is broken, sagging, misaligned, or if shackles spring hangar(s) are worn or loose.
5. Any deflated air suspension leaking that affects the normal function of the suspension system or is seriously deteriorated (cracks, patches, rubber soft or oil soaked) system or leaks.

CAUTION: Underneath inspection of a vehicle equipped with air suspension with excessive leakdown could result in serious personal injury.

6. Any suspension system defect or any condition of loading that permits the body or frame to come in contact with a tire or any part of the wheel assemblies.

NOTE: "All thread rod" material shall not be used as U-bolts in the suspension system.

7. Sliding trailer tandem or multi-axle assemblies do not lock in place or have broken or missing parts.

8. Any coil spring is broken.

9. Vehicles with composite trailer springs if a crack, regardless of length, is visible on either side, top or bottom.

NOTE: A crack is a separation in any axis which passes completely through the spring.

19 VAC 30-70-490. Frame, engine mounts, coupling devices and emergency chains.

Inspect for and reject if:

1. ~~Frame or unitized body of any motor vehicle, trailer or semitrailer is broken or cracked at any location, including any welded joint and/or is rusted or corroded to the point the frame is weakened of any bus, truck, truck tractor is cracked, loose or sagging.~~

a. Frame of any trailer or semi-trailer has any broken or cracked top or bottom frame rails or frame is cracked or broken.

2. Engine or transmission mounts are broken or missing.

3. Trailer hitch or pintle hook is not securely attached.

Reject if the pintle eye or trailer drawbar has any cracks or if any welding repairs have been made to the pintle eye.

4. Chains, cables, etc., used to attach a towed vehicle are not securely attached, or are broken, worn or abraded.

5. Fifth wheel does not lock in position or have a locking mechanism that is in proper working order.

NOTE: Reject if horizontal movement exceeds 1/2 inch between upper and lower fifth wheel halves.

6. Fifth wheel assembly system has any leak of fluid or air.

7. Fifth wheel has any broken, missing, or damaged parts; or is not securely attached to the frame. This includes fore and aft stops.

8. Trailer kingpin is not secure, or is broken, or worn so as to prevent secure fit in fifth wheel. The upper coupler device is not securely attached.

9. Any cracks, breaks or damaged parts in the stress or load bearing areas of a coupling device.

10. Trailer is not equipped with an emergency chain or chains.

NOTE: Fifth wheel assembly does not require emergency chains. A fifth wheel is defined as a device which interfaces with and couples to the upper coupler assembly of a semitrailer. The upper coupler assembly is a structure consisting of an upper coupler plate, kingpin and supporting framework which interfaces with and couples to a fifth wheel. Ball and socket connections also referred to as hitch and coupling connections are not fifth wheel assemblies and do not require safety chains.

11. *Reject if sliding trailer tandem or multi-axle assemblies do not lock in place or have worn, broken or missing parts.*

19 VAC 30-70-500. Tires, wheels, rims.

Inspect for and reject if:

1. Any tire is marked specifically for use other than on the highway, such as "For Farm Use Only," or "For Off-Highway Use Only," or any tire marked "Not for Steering Axle."
2. A radial tire is mismatched on the same axle with a bias ply tire or a bias belted tire.
3. Bias ply or bias belted tires are used on the rear axle when radial ply tires are used on the front axle. Except:
 - a. On a two-axle vehicle equipped with truck tires with 20-inch rim diameter and larger, bias or radial tires may be used on either axle if the vehicle has dual rear wheels, or is equipped with wide-base single tires.
 - b. Either bias or radial tires may be used on the steering axle of vehicles with three or more axles.
4. Bias tires and radial tires are mixed in a tandem-drive axle combination on a vehicle equipped with truck tires with 20-inch rim diameter and larger.
5. Any tire on the front wheel of a bus, truck or any tractor truck has a tread groove pattern of 4/32 inch or less when measured at any point on a major tread groove.
6. Any bus has regrooved, recapped or retreaded tires on the front wheels.
7. Any motor vehicle, trailer or semitrailer, except the dual wheels installed on motor vehicles having seats for more than seven passengers: (i) operated wholly within a municipality, or (ii) operated by urban and suburban bus lines, which are defined as bus lines operating over regularly scheduled routes and the majority of whose passengers use the buses for traveling a distance of not exceeding 40 miles, measured one way, on the same day between their place of abode and their place of work, shopping areas, or schools, is equipped with a tire which has a tread depth measuring less than 2/32 of an inch when measured as follows: NOTE: The exemptions provided in clauses (i) and (ii) of this paragraph do not apply to buses owned or operated by

any public school district, private school or contract operator of buses.

8. Measure in two adjacent tread grooves where tread is thinnest. If either of the grooves measure 2/32 of an inch or more, no further measurements are necessary and tread depth is satisfactory. Do not measure on tread wear indicators.

If both adjacent grooves measure less than 2/32 of an inch, the tire tread depth must be measured again at two additional equally spaced intervals around the circumference of the tire in a like manner as the first measurement. If the tread depth is less than 2/32 of an inch in two adjacent tread grooves at each of the equally spaced intervals, the tire must be rejected.

NOTE: Refer to Figures 1, 2, 3, and 4 in this section for illustrations of how to measure tire tread.

MEASURE WHERE THE TREAD IS THINNEST IN TWO ADJACENT TREAD GROOVES

FIGURE 1

IF THE DEPTH IS LESS THAN 2/32-INCH IN BOTH GROOVES MEASURE AT TWO ADDITIONAL EQUALLY SPACED INTERVALS

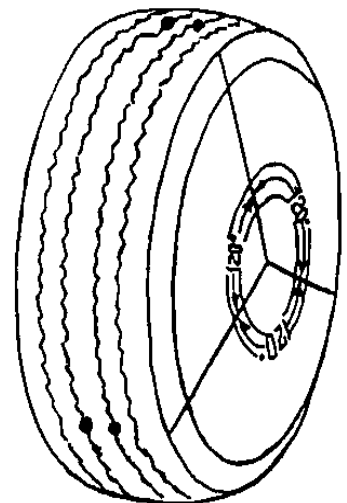

9. A tire equipped with tread wear indicators if found to have such indicators in contact with the pavement in any two adjacent grooves at three equally spaced intervals around the circumference of the tire. Refer to Figure 2.

REJECT IF THE TREAD WEAR INDICATORS ARE IN CONTACT WITH THE PAVEMENT IN ANY TWO ADJACENT GROOVES AT THREE EQUALLY SPACED LOCATIONS

FIGURE 2

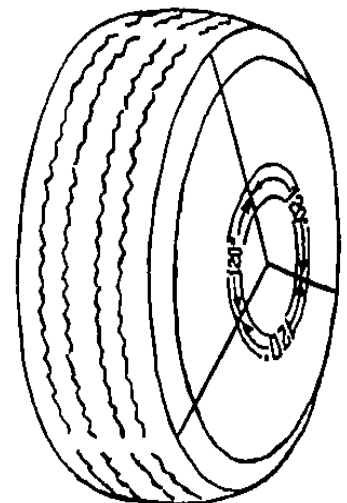

Final Regulations

10. Any tire has a cut ~~into the fabric to the extent a ply or belt material is exposed.~~

11. Any tire is worn so that the fabric or steel cord is visible.

12. Any tire has knots or bulges in its sidewalls or if there is evidence of a broken belt under the tread, or if the tread is separating from the fabric.

13. Any tire which has been recut or regrooved except commercial tires so designed and constructed to provide for acceptable and safe recutting and regrooving. Each tire that has been regrooved must be labeled with the word "Regroovable" molded on or into the tire on both sidewalls in raised or recessed letters.

~~14. Any bolts, nuts or lugs are loose, missing or damaged.~~

~~15. Wheels are installed on the vehicle in a reversed position, except the wheels on vehicles which are reversed to perform a part of a dual wheel combination.~~

14. Any tire is flat or has an audible air leak.

15. Any tire so mounted or inflated that it comes into contact with its mate or any parts of the vehicle.

16. Rims, or lock rings or wheels are bent, cracked or damaged so as to affect safe operation of the vehicle. Reject if lug nut holes are elongated (out of round).

~~17. Any tire is flat or has an audible air leak.~~

~~18. Any tire so mounted or inflated that it comes into contact with its mate or any parts of the vehicle.~~

~~19. Any tire and rim size are not the same.~~

17. Any [bolts, nuts, lugs or other] fasteners (both spoke and disc wheels) are loose, broken, cracked, stripped, missing or damaged or otherwise ineffective [fasteners].

~~20. Commercial motor vehicles with a gross vehicle weight of 26,001 pounds or more have~~ 18. Any welded repair on aluminum wheel(s) on a steering axle or any welded repair (other than disc to rim attachment) on steel drive wheel(s) mounted on the steering axle.

FIGURE 3

ATTACHED TO BWCS NOTICE DATED 8/21/69

HOW TO MEASURE TIRE TREAD

When measuring tread depth, a gauge calibrated in 32nds of an inch should be used.

The gauge should be placed at the point in one of the treads indicated by an arrow. Depth reading should not be taken in treads marked with a circle, since these are classified as "minor" treads.

Persons taking measurements will have to use discretion in measuring tread depths not pictured here, however, measurements should not be made in treads which are obviously of a "minor" nature.

This guide merely depicts a number of the most common treads.

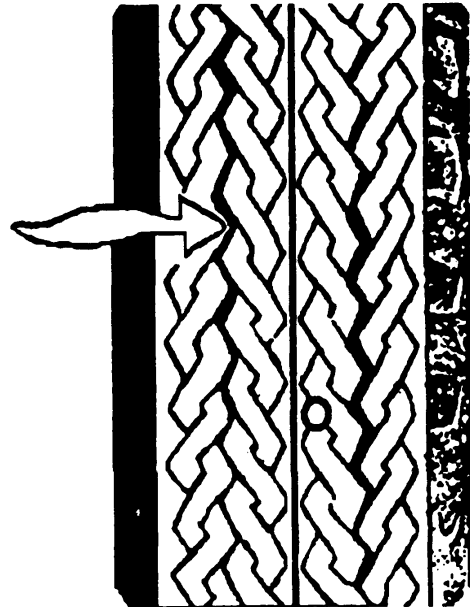

MAJOR TREAD GROOVE

Grooves in the tread design molded through the complete thickness of the tread rubber running around and/or across the tire surface



MINOR TREAD GROOVE
Remaining tire tread design other than major tread grooves.



TIE-BAR
Molded rubber located in major tread grooves for the purpose of connecting and supporting the tire treads.

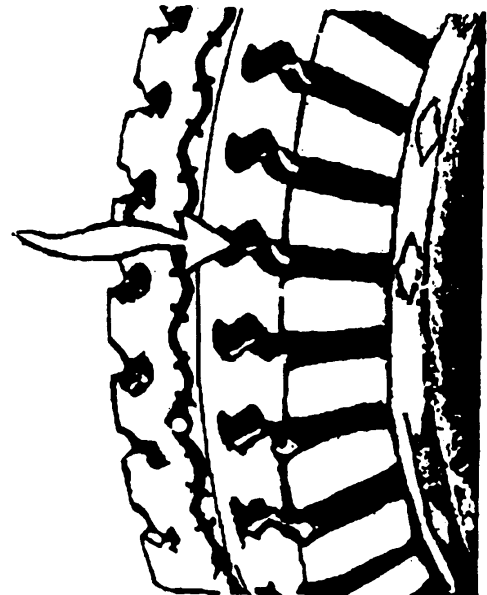
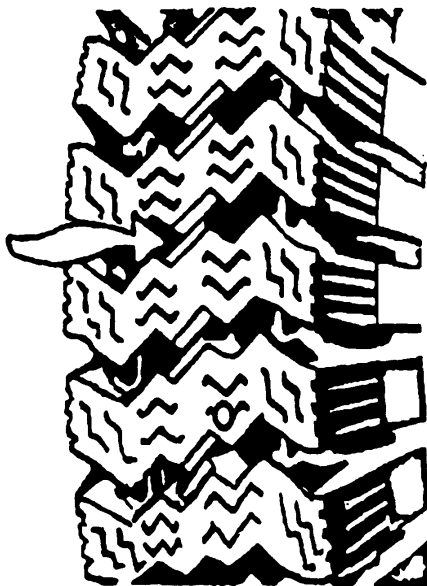

FIGURE 4



19 VAC 30-70-550. Clearance lamps and reflectors.

Inspect for and reject if:

1. Any motor vehicle, trailer, semitrailer or other vehicle is not equipped with clearance lamps if the vehicle is over seven feet wide or if any portion extends four inches or more outside the front fender line.

When a motor vehicle with a trailer attached is presented, the combination may be considered as one unit in meeting this requirement. If presented separately, the individual unit must meet these requirements except that any tractor-truck need not be equipped with rear red dimension or marker lamps.

2. Lamps and reflectors are not of an approved type or a lamp has been altered.

Reject if the lamps or reflectors have unapproved plastic covers, any other materials which are not original equipment or any colored material placed on or in front of lamps or reflectors.

3. Lenses on lamps on the front are not yellow or amber and lenses on lamps on the rear are not red or if a lens has a piece broken from it. A lens may have one or more cracks provided an off-color light does not project through the crack or cracks.

4. Wiring or electrical connections are defective, all filaments do not burn.

5. Two amber lamps are not mounted on the front and two red lamps on the rear, so as to indicate the extreme width of the body, and as high on the permanent body as practical, except that approved 180 degree lamps with yellow or amber lens may be mounted on the side of the vehicle at or as near the front as possible, or if the front is not the widest portion, the lamps may be installed on the side and as near that point as possible. And with the further exception that 180 degree lamps with red lens may be mounted on the side of the vehicle at or as near the rear as possible or if the rear is not the widest portion of the vehicle, the lamps may be installed on the side as near that point as possible.

6. Any vehicle equipped with three red identification lamps with the lamp centers spaced not less than six inches or more than 12 inches apart and installed as close as practicable to the top of the vehicle and as close as practicable to the vertical centerline of the vehicle may have the rear dimension or marker lamps required by paragraph 5 above mounted at any height but indicate as nearly as practicable the extreme width of the vehicle.

7. Dump trucks with a high lift body, concrete mixer trucks and other specially constructed vehicles may be equipped with the required clearance lamps not mounted on the extreme rear, provided such red lamps are clearly visible from the rear and provided further that two red reflectors of an approved type are mounted on the extreme rear. In unusual cases the rear lamp may

be mounted on the cab and another red reflex reflector placed on the extreme rear.

8. In addition to the required clearance lamps showing to the front and to the rear, a vehicle may be equipped with clearance lamps on the side of the vehicle. When such an installation is used, all of the clearance lamps on the side except the one at or near the rear must have an amber lens. The clearance lamps on the side at or near the rear must have a red lens.

9. Any vehicle covered by subdivision 1 of this section, except school buses, is not equipped with amber reflectors on the sides as near the front as practical, and red reflectors on the rear. The reflectors must be at least 24 1/2 inches and not more than 60 inches from the ground. No reflector can have a piece broken from its reflective surface, but may have one or more cracks.

10. Any combination of vehicles whose actual length exceeds 35 feet if the vehicles are not wide enough to have clearance lights, if the vehicle is not equipped with reflex reflectors of a type approved by the superintendent and mounted on the widest part of the towed vehicle so as to be visible from the front and sides of the vehicle. No reflector can have a piece broken from its reflective surface, but may have one or more cracks.

11. Any passenger vehicle is equipped with clearance lamps, unless such lamps are used to mark the extreme width of the vehicle or used as taxicab identification, or used as supplemental turn signals. (See 19 VAC 30-70-190, ~~paragraph B.~~)

12. Vehicles so constructed as to make compliance with the requirements of ~~paragraphs~~ subdivisions 1, 5, 7, 9 and 10 of this section impractical will be equipped with clearance lamps and reflectors at the most practical location to provide maximum visibility.

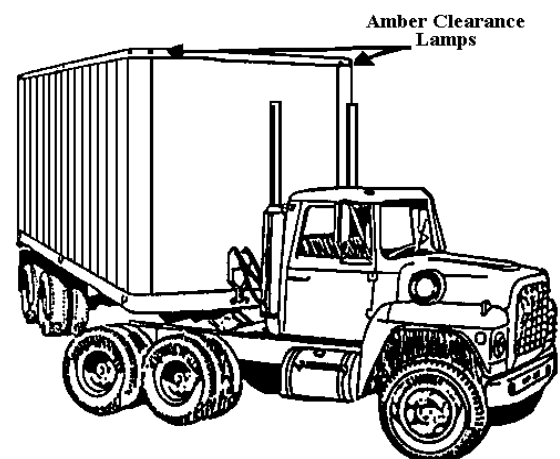

Final Regulations

RED CLEARANCE LAMPS

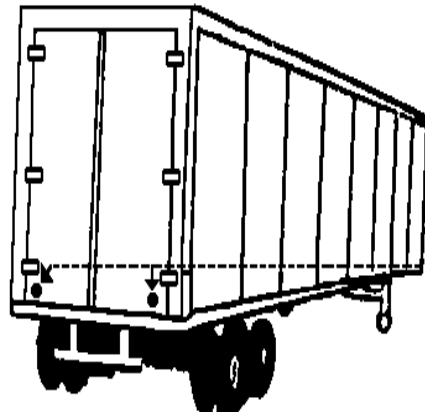
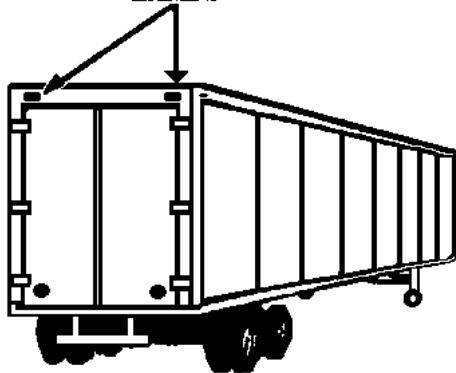

Red Reflectors --
At least 24 15 inches and not more than 60 inches from the ground

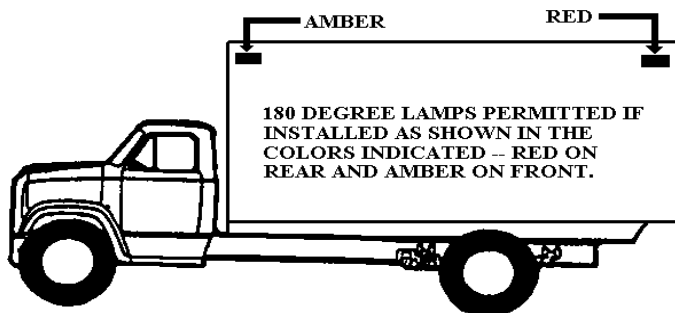

19 VAC 30-70-570. Permissible lighting equipment.

A. Any vehicle may be equipped with:

- ~~1. Magneto or acetylene lighting, if original equipment and if otherwise in conformity with these rules and regulations and Virginia statutes.~~
- ~~2. 1. Running board or courtesy lamps, of not over six candlepower.~~
- ~~3. 2. Vacant or destination signs, if a taxicab or bus.~~
- ~~4. 3. Identification lamps of approved type.~~
- ~~5. Front fender clearance jewels, if amber or yellow.~~
- ~~6. 4. Interior lights. (Not more than 15 candlepower.)~~

Exception: This does not apply to alternating, blinking or flashing colored emergency lights mounted inside law-enforcement vehicles or flashing, shielded red or red and white lights, mounted inside vehicles owned by members of volunteer fire companies, volunteer rescue squads or owned or used by professional firefighters.

~~7. Hood ornament light if of a type approved or permitted by the superintendent.~~

~~8. 5. A motor vehicle having a GVWR of ~~26,001~~ 10,001 pounds or more may be equipped with an illuminated bumper guide attached to each end of the front bumper, provided:~~

- a. The light thereon is amber in color and less than 6 candle-power.
- b. The light is wired to burn only in conjunction with the marker or clearance lamps on the vehicle.

~~9. 6. Any approved lamp in good working order when used for the purpose for which it was approved.~~

B. ~~Side Marker Lamps:~~ Side marker lamps are not required if *the vehicle(s) is over 30 feet in length*. If installed they must operate and be inspected. If the bulb, socket and wiring are removed from an individual lamp unit, the unit will not be considered during inspection.

Inspect for and reject if:

If equipped with three red identification lamps, the required clearance lamps may be mounted at any height so long as they indicate, as nearly as practicable, the extreme width of the vehicle.

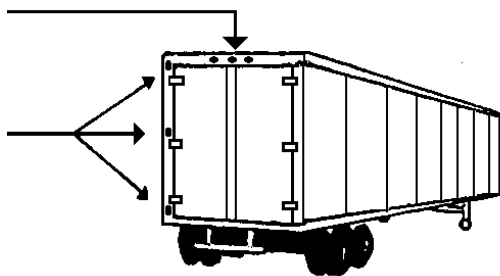

ILLUSTRATIONS FOR PROPER INSTALLATION OF REFLECTORS

Amber Reflector

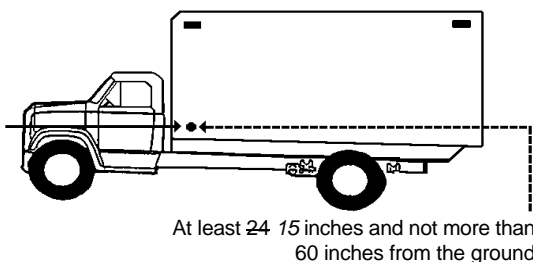

1. Lamps are not of an approved type, or do not comply with subsection A of this section.
2. Lamps are not installed on the permanent structure of the vehicle with one as far to the rear and one as far forward as practicable and at a location which is not less than 15 inches above the road surface when measured from the center of the lamp.
3. Lamps installed on the side to the rear do not project a red light and lamps installed on the front do not project an amber light.
4. Lens has a piece broken from it. The lens may have one or more cracks provided no off-color light projects through the crack or cracks.
5. Wiring or electrical connections are defective or filaments do not burn.
6. Any vehicle has unapproved lens or plastic covers, any other materials which are not original equipment or any colored material placed on or in front of permissible lighting equipment.

19 VAC 30-70-580. Glazing.

A. Motor vehicles may be inspected without windshields, side glasses, or any kind of glazing except that any motor vehicle other than a motorcycle which was manufactured, assembled, or reconstructed after July 1, 1970, must be equipped with a windshield. If glass or other glazing is installed, it must be inspected. If no windshield is installed, see 19 VAC 30-70-50, ~~subsection C~~, for location of the sticker.

B. Inspect for and reject if:

1. Any motor vehicle manufactured or assembled after January 1, 1936, or any bus or school bus manufactured or assembled after January 1, 1935, is not equipped throughout with safety glass, or other safety glazing material. (This requirement includes slide-in campers used on pickups or trucks, caps, or covers used on pickup trucks, motor homes, and vans.)
2. Any safety glass or glazing used in a motor vehicle is not of an approved type and properly identified. (Replacement safety glass installed in any part of a vehicle other than the windshield need not bear a trademark or name, provided the glass consists of two or more sheets of glass separated by a glazing material, and provided the glass is cut from a piece of approved safety glass, and provided the edge of the glass can be observed.)
3. Any glass at any location where glass is used is cracked or broken so that it is likely to cut or injure a person in the vehicle.
4. Windshield has any cloudiness more than three inches above the bottom, one inch inward from the outer borders, one inch down from the top, or one inch inward from the center strip. The bottom of the windshield shall be defined as the point where the top of the dash contacts the windshield.

5. Any distortion or obstruction that interferes with a driver's vision.

- a. Any hood scoop installed on any motor vehicle manufactured for 1990 or earlier model year cannot exceed 2¼ inches high at its highest point measured from the junction of the dashboard and the windshield.
- b. Any hood scoop installed on any motor vehicle manufactured for the year 1991 or subsequent model year cannot exceed 1½ inches high at its highest point measured from the junction of the dashboard and the windshield.

6. Windshield glass, on the driver's side, has any scratch more than ¼ inch in width and six inches long within the area covered by the windshield wiper blade, excluding the three inches above the bottom of the windshield.

EXCEPTION: Do not reject safety grooves designed to clean wiper blades if the grooves do not extend upward from the bottom of the windshield more than six inches at the highest point.

7. There is a pit, chip, or star crack larger than 4½ inches ~~¼ inch~~ in diameter at any location in the windshield above the ~~three-inch line at the bottom~~ *topmost portion of the steering wheel except the two-inch border at the top and the one-inch border at each side.*

8. At any location ~~in the windshield above the three-inch line at the bottom there is more than one crack from the same point if at least one of the cracks is more than 1½ inches in length. There is any crack that weakens the windshield so that one piece may be moved in relation to the other. (If there is more than one crack running from a star crack that extends above the three-inch line, the windshield shall be rejected.)~~ *above the topmost portion of the steering wheel excluding a two-inch border at the top and one-inch border at the sides there is:*

- a. Any crack over ¼ inch in width.
- b. Any crack ¼ inch or less in width intersected by another crack.
- c. Any damage area ¾ inch or less in diameter if within three inches of any other damage area.

9. Any sticker is on the windshield other than an official one required by law, or permitted by the Superintendent. Authorization is hereby granted to stickers measuring not more than 2½ inches in width and four inches in length to be placed in the blind spot behind the rear view mirror. Any sticker required by law must be placed adjacent to the official inspection sticker and must not extend upward more than three inches from the bottom of the windshield; except, on vehicles operating in interstate commerce, under rules and regulations of ICC, stickers required by law must not extend upward more than 4½ inches from the bottom of the windshield. A valid Commercial Vehicle Safety Alliance or motor

Final Regulations

carrier inspection sticker issued by certified law-enforcement agencies not exceeding three inches in height and two inches in width may be placed at the lower right corner of the windshield on trucks and tractor-trucks having a GVWR of 26,001 pounds or more.

Any sticker required by the laws of any other state or District of Columbia and displayed upon the windshield of a vehicle submitted for inspection in this state is permitted by the superintendent, provided the vehicle is currently registered in that jurisdiction, the sticker is displayed in a manner designated by the issuing authority and has not expired. This includes vehicles with dual registration, i.e., Virginia and the District of Columbia.

10. Stickers or decals used by counties, cities and towns in lieu of license plates may be placed on the windshield without further authority. Except on privately owned yellow school buses, the sticker or decal shall be placed on the windshield adjacent to the right side of the official inspection sticker. The top edge of the sticker or decal shall not extend upwards more than three inches from the bottom of the windshield. The left side edge adjacent to the official inspection sticker shall not be more than ¼ inch from the right edge of the official inspection sticker when looking through the windshield from inside the vehicle. However, at the option of the motor vehicle owner, the sticker or decal may be affixed to the upper edge of the center of the windshield. (Any expired sticker or decal present on the windshield at the time of inspection shall be removed, excluding a rejection sticker.) On privately owned yellow school buses, the sticker or decal shall be placed on the windshield adjacent to the left side of the official inspection sticker, and not more than ¼ inch from the official inspection sticker when looking through the windshield from inside the vehicle. The top edge of the sticker shall not extend upward more than three inches from the bottom of the windshield.

11. ~~Sunshading~~ Any material attached to the windshield extends more than three inches downward from the top of the windshield, unless authorized by a medical waiver certificate, or replacement of the sunshield in the uppermost area as installed by the manufacturer of the vehicle.

NOTE: ~~Sunshading~~ Any material on windshield displaying words, lettering, numbers or pictures is not approved and is not permitted.

12. Any sunscreening material is scratched, distorted, wrinkled or obscures or distorts clear vision through the glazing.

13. Front side windows have cloudiness above three inches from the bottom of the glass, or other defects that affect the driver's vision or one or more cracks which permit one part of the glass to be moved in relation to another part. Wind silencers, breezes or

other ventilator adaptors are not made of clear transparent material.

14. Glass in the left front door cannot be raised or lowered easily so a hand signal can be given. (This does not apply to vehicle equipped with approved turn signals which were not designed and/or manufactured for left front glass to be lowered.) If either front door has the glass removed and material inserted in place of the glass which could obstruct the driver's vision.

Exception: Sunscreening material is permissible if the vehicle is equipped with a mirror on each side.

15. Any sticker or other obstruction is on either front side window, rear side windows, or rear windows. (The price label, fuel economy label and the buyer's guide required by federal statute and regulations to be affixed to new/used vehicles by the manufacturer shall normally be affixed to one of the rear side windows.) If a vehicle only has two door windows, the labels may be affixed to one of these windows. If a vehicle does not have any door or side windows the labels may be temporarily affixed to the right side of the windshield until the vehicle is sold to the first purchaser.

NOTE: A single sticker no larger than 20 square inches in area, if such sticker is totally contained within the lower five inches of the glass in the rear window or a single sticker or decal no larger than 10 square inches located in an area not more than three inches above the bottom and not more than eight inches from the rearmost edge of either front side window, is permissible and should not be rejected.

Do not reject a tractor truck having a gross vehicle weight rating of 26,001 pounds or more equipped with one optically grooved clear plastic wide angle lens affixed to the right front side window. Such wide angle lens shall not extend upward from the bottom of the window opening more than six inches or backward from the front of the window opening more than eight inches.

16. Rear window is clouded or distorted so that the driver does not have a view 200 feet to the rear.

EXCEPTIONS: The following are permissible if the vehicle is equipped with a mirror on each side:

a. There is attached to one rear window of such motor vehicle one optically grooved clear plastic right angle rear view lens, not exceeding 18 inches in diameter in the case of a circular lens or not exceeding 11 inches by 14 inches in the case of a rectangular lens, which enables the operator of the motor vehicle to view below the line of sight as viewed through the rear window.

b. There is affixed to the rear side windows, rear window or windows of such motor vehicle any sticker or stickers, regardless of size.

c. There is affixed to the rear side windows, rear window or windows of such motor vehicle a single

layer of ~~any approved~~ sunshading material, ~~VAT-1, VAT-2 and VAT-3.~~

d. Rear side windows, rear window or windows is clouded or distorted.

19 VAC 30-70-680. Fuel system.

Inspect for and reject if:

1. Any part of the fuel system is not securely fastened.
2. There is fuel leakage at any point in ~~the~~ *any* fuel system.
3. ~~The~~ *Any* fuel tank filler cap is missing.
4. ~~The~~ *Any* fuel tank crossover lines are not protected *if they extend more than two inches below the bottom of the tank or sump.*
5. Any part of the fuel system comes in contact with the exhaust system.

VA.R. Doc. No. R98-51; Filed September 24, 1998, 3:08 p.m.



THE LEGISLATIVE RECORD

[The Legislative Record is available on
the Internet at <http://dls.state.va.us/>]

**[The Legislative Record is available on
the Internet at <http://dls.state.va.us/>]**

**[The Legislative Record is available on
the Internet at <http://dls.state.va.us/>]**

**[The Legislative Record is available on
the Internet at <http://dls.state.va.us/>]**

**[The Legislative Record is available on
the Internet at <http://dls.state.va.us/>]**

**[The Legislative Record is available on
the Internet at <http://dls.state.va.us/>]**

**[The Legislative Record is available on
the Internet at <http://dls.state.va.us/>]**

**[The Legislative Record is available on
the Internet at <http://dls.state.va.us/>]**

**[The Legislative Record is available on
the Internet at <http://dls.state.va.us/>]**

**[The Legislative Record is available on
the Internet at <http://dls.state.va.us/>]**

**[The Legislative Record is available on
the Internet at <http://dls.state.va.us/>]**

GENERAL NOTICES/ERRATA

SPECIAL JOINT SUBCOMMITTEE TO STUDY CERTIFICATE OF PUBLIC NEED

Invitation to Submit Written Proposals

The Special Joint Subcommittee to Study Certificate of Public Need invites all interested parties to submit written proposals relating to any Virginia laws relevant to certificate of public need and regulation of health facilities. The members of the Special Joint Subcommittee are Senator Jane H. Woods, Chairman; Delegates Jay W. DeBoer, Phillip A. Hamilton, Kenneth R. Melvin, and John H. Rust; and Senators Emily Couric, John S. Edwards, and Frederick M. Quayle.

Interested parties are requested to be concise and to submit written proposals by October 15 to Norma E. Szakal, Senior Attorney, Division of Legislative Services, 910 Capitol Street, Richmond, Virginia 23219. Questions may be directed to Ms. Szakal at (804) 786-3591. Responders are advised that all proposals may be paraphrased for incorporation in a matrix for the November 12 meeting of the Special Joint Subcommittee.

Written proposals may involve specific amendments or alternatives to any relevant state law, alternatives or amendments to the COPN law or other health facility law, and any other changes or suggestions, including that there be no change in specific law. Responders are encouraged to consider the impact of their suggestions on access to health care, funding of indigent care, and the development of an efficient and effective health care system in Virginia. The administrative contact is Brian Taylor, (804) 698-7450.

STATE CORPORATION COMMISSION

EDITOR'S NOTICE: The distribution list which is referenced in the following order as the PUA Service List is not being published. However, this list is available for public inspection at the State Corporation Commission, Document Control Center, Tyler Building, 1300 East Main Street, 1st Floor, Richmond, Virginia, from 8:15 a.m. to 5 p.m., Monday through Friday.

AT RICHMOND, SEPTEMBER 18, 1998

COMMONWEALTH OF VIRGINIA, *ex rel.*

STATE CORPORATION COMMISSION

CASE NO. PUA980020

Ex Parte: In the matter of adopting rules governing the filing of applications for approval pursuant to Chapter 4 of Title 56 of the Code of Virginia

ORDER EXTENDING TIME FOR FILING COMMENTS

By order entered on July 21, 1998 ("July 21 Order"), the Commission invited interested persons to file comments

addressing the proposed rules governing applications for approval of affiliate transactions under Chapter 4 of Title 56 of the Code of Virginia on or before September 21, 1998.¹

On September 15, 1998, Appalachian Power Company, d/b/a American Electric Power Co., Inc. ("APCO"), filed a request for extension of time by which to submit its written comments. APCO requested that it be permitted to file its comments by October 2, 1998. It explained that because the complex ramifications of the proposed rules have required extensive analysis, the preparation of its comments has taken longer than expected. Additionally, we have been advised by our staff that they have been informally contacted by other interested stakeholders requesting that the time for filing comments on the proposed rules by extended.

NOW THE COMMISSION, having considered the matter, is of the opinion and finds that extending the time for the filing of comments on the proposed rules by 45 days is reasonable in light of the complexity of the subject and the importance of formulating appropriate rules governing affiliate transactions. Accordingly,

IT IS ORDERED that the time by which comments concerning the proposed rules addressing affiliate transactions is extended from September 21, 1998, to November 5, 1998.

AN ATTESTED COPY HEREOF shall be sent by the Clerk of the Commission to the PUA Service List attached hereto, and the Commission's Divisions of Public Utility Accounting, Communications, and Energy Regulation.

¹ The proposed rules may be found in Attachment A to the July 21 Order.

Bureau of Insurance

August 28, 1998

ADMINISTRATIVE LETTER 1998-9

TO: ALL INSURERS LICENSED TO WRITE ACCIDENT AND SICKNESS INSURANCE IN VIRGINIA, AND ALL HEALTH SERVICES PLANS AND HEALTH MAINTENANCE ORGANIZATIONS LICENSED IN VIRGINIA

RE: Amendments to Rules Governing Minimum Standards for Medicare Supplement Policies

The federal Balanced Budget Act of 1997 (BBA) (Public Law 105-33, August 5, 1997), establishes a new Part C in Medicare (Medicare+Choice) and creates additional standards for Medicare supplement insurance policies. Section 4031(e) of the BBA provides that states will have one year from the date the NAIC modifies its Model Regulation to Implement the NAIC Medicare Supplement Insurance Minimum Standards Model Act (Model regulation) to revise their statutes and/or regulations. The NAIC completed its

General Notices/Errata

revision of the Model regulation on April 29, 1998; as such states have until April 29, 1999 to revise their regulations and/or statutes. Although Virginia has until April 29, 1999 to amend its **Rules Governing Minimum Standards for Medicare Supplement Policies** (14 VAC 5-170-10 et seq.), insurance companies issuing Medicare supplement policies in this Commonwealth are subject to the Medicare supplement provisions in the BBA regardless of the status of Virginia's regulation.

The BBA requires the following changes to Medicare supplement insurance policies effective July 1, 1998:

- Guaranteed issue without preexisting conditions for continuously covered individuals (guaranteed issue)
- Limitation on imposition of preexisting condition exclusion during initial open enrollment period (preexisting condition exclusion)

The additional new High Deductible Medicare Supplement Policies (High Deductible Plan F and High Deductible Plan J) will not be required to be offered in Virginia until Virginia amends its regulation. The amended regulation will also include changes and additions to the disclosure statements.

With regard to the guaranteed issue provision of the BBA, **eligible persons** means those individuals who apply to enroll under the policy not later than 63 days after the date of termination of enrollment and who submit evidence of the date of termination of enrollment or disenrollment with the application for a Medicare supplement policy. With respect to eligible persons, an issuer shall not:

1. Deny or condition the issuance or effectiveness of a Medicare supplement policy that is offered and is available for issuance to new enrollees by the issuer;
2. Discriminate in the pricing of such a Medicare supplement policy because of health status, claims experience, receipt of health care, or medical condition; or
3. Impose an exclusion of benefits based on a preexisting condition under such a Medicare supplement policy.

The limitation on imposition of preexisting condition exclusions applies to a policy issued during the six-month initial open enrollment period to an individual who is 65 years of age or older and who, as of the date of application for enrollment, has had a continuous period of creditable coverage of at least six months, in which case the policy may not exclude benefits based on a preexisting condition. If the period of creditable coverage is less than six months, any preexisting condition exclusion period must be reduced by the aggregate of the periods of creditable coverage. The manner of this reduction (currently a proportional day-for-day reduction) will be determined by the Secretary of Health and Human Services.

With regard to the preexisting condition exclusion provision of the BBA, creditable **coverage** means with

respect to an individual, coverage of the individual provided under:

1. A group health plan;
2. Health insurance coverage;
3. Part A or Part B of Title XVIII of the Social Security Act (Medicare);
4. Title XIX of the Social Security Act (Medicaid), other than coverage consisting solely of benefits under Section 1928;
5. Chapter 55 of Title 10 United States Code (CHAMPUS);
6. A medical care program of the Indian Health Service or of a tribal organization;
7. A state health benefits risk pool;
8. A health plan offered under Chapter 89 of Title 5 United States Code (Federal Employees Health Benefits Program);
9. A public health plan as defined in federal regulation; and
10. A health benefit plan under Section 5(e) of the Peace Corps Act (22 U.S.C. 2504(e)).

Insurance companies issuing Medicare supplement policies are required to comply with the BBA on and after July 1, 1998.

All forms revised to comply with these requirements must be submitted to the Bureau of Insurance for approval prior to their use in the Commonwealth of Virginia. Insurance companies are obligated to follow the federal law regardless of the status of form filings with the Bureau of Insurance.

Questions regarding the contents of this letter should be directed to:

Jacqueline K. Cunningham
Supervisor, Forms and Rates Section
State Corporation Commission
Bureau of Insurance -- Life and Health Division
Post Office Box 1157
Richmond, Virginia 23218

Telephone: (804) 371-9110
FAX: (804) 371-9944

/s/ Alfred W. Gross
Commissioner of Insurance

VA.R. Doc. No. C99-2: Filed September 1, 1998, 3:35 p.m.

August 25, 1998

Administrative Letter 1998-10

TO: All Title Insurance Companies Licensed in Virginia and All Title Insurance Settlement Agents Registered in Virginia

RE: Revised Guidelines for Conducting Title Insurance Company/Underwriter Analyses of Escrow Accounts Maintained by Title Insurance Settlement Agents (All changes to Administrative Letter 1998-1 are italicized)

In accordance with the legislative amendments enacted during the 1998 Session of the Virginia General Assembly, attached are the State Corporation Commission Bureau of Insurance guidelines for conducting title insurance company/underwriter analyses of escrow accounts maintained by title insurance settlement agents pursuant to Virginia Code § 6.1-2.21 E 2 and 14 VAC 5-395-50 C. The results of the analyses are required to be filed with the Bureau of Insurance within 60 days of completion of the analysis.

Any accounting or auditing questions pertaining to these guidelines should be referred to David Smith at (804) 371-9061. Any other questions should be referred to Michael Beavers at (804) 371-9465.

Please make sure that the appropriate person within your organization receives these guidelines.

/s/ Alfred W. Gross
Commissioner of Insurance

REVISED GUIDELINES FOR CONDUCTING TITLE INSURANCE COMPANY/UNDERWRITER ANALYSES OF ESCROW ACCOUNTS MAINTAINED BY TITLE INSURANCE AGENTS PURSUANT TO THE VIRGINIA CONSUMER REAL ESTATE SETTLEMENT PROTECTION ACT (Virginia Code § 6.1-2.19 et seq.)

Title insurance companies/underwriters conducting analyses of title insurance agent escrow accounts pursuant to Virginia Code § 6.1-2.21 E 2 and 14 VAC 5-395-50 C shall comply with the following guidelines. The guidelines are intended to be used as minimum guidelines in conducting analyses of title insurance agent escrow accounts. Additional procedures conducted by the title insurance companies should be documented in the Standard Report (see attached) issued by the title insurance company. The results of such analyses of escrow accounts maintained by title insurance agents are required to be filed with the Bureau of Insurance within sixty days of the completion of the analysis.

1. Obtain a listing of all agency bank accounts, including operating and other non-fiduciary accounts. Have the agent certify that the listing of bank accounts is complete and accurate. The listing should contain all of the information that is included in Schedule A of the Standard Report.
2. Obtain a listing of all of the agency's affiliated companies.* Have the agent certify that the listing of affiliated companies is complete and accurate. The listing should contain all of the information that is included in Schedule B of the Standard Report.
3. Review and test the agent's 3-way reconciliations (bank statement to book balance to open escrow trial balance) for the most recent monthly period available for all agent escrow accounts including, without limitation, all multiple and individual customer escrow accounts (regular, special/interest bearing, etc.), accounts established in connection with IRC Code § 1031 tax deferred exchanges, and other fiduciary accounts. The test of the reconciliations should, at a minimum, include the following procedures:
 - a. Foot reconciliation and any supporting schedules;
 - b. Compare bank balance per reconciliation with bank statement and have agent resolve differences;
 - c. Compare book balance per reconciliation with control account such as check book balance, general ledger, etc. and have agent resolve differences;
 - d. Compare reconciled balances to the related trial balance of the same date and have agent resolve differences;
 - e. Verify deposits in transit by tracing deposits to validated deposit slip or bank statement for the following month;
 - f. Verify outstanding check list by tracing to canceled checks returned with the subsequent month's bank statement. Follow up on all large outstanding checks not clearing in the subsequent month;
 - g. Verify propriety of other material reconciling items by reviewing appropriate support;
 - h. Note any material reconciling items more than 30 days old and discuss with agency personnel;
 - i. Examine voided checks and verify that they are properly defaced.
4. Review 3-way reconciliations for all agent escrow accounts (same accounts as referred to in Item # 3 of these Guidelines) for three months of the preceding twelve-month period which shall be selected on a random basis. Determine the timeliness of the preparation of bank reconciliations. Determine management review and approval. Any reconciliations that were not prepared in a timely manner or reviewed by management should be noted in the Specific Findings section of the Standard Report.
5. Review the agent's trial balance for the most recent monthly period available for all escrow accounts for unusual items and investigate any such items. The lack of a timely trial balance and/or any unusual items that are not adequately resolved by the person performing

General Notices/Errata

the analysis should be noted in the Specific Findings section of the Standard Report.

6. Review all escrow account bank statements and trial balances for unusual items, e.g. negative balances, non-sufficient funds or other large or frequent bank service charges, or large even-dollar disbursements, and investigate any such items. Any unusual items that are not adequately resolved by the *person performing the analysis* should be noted in the Specific Findings section of the Standard Report.
7. For each escrow account, select a representative sample of canceled checks and wire transfers *for the preceding twelve-month period* and review same for unusual items. The actual number of canceled checks and wire transfers sampled should be disclosed in the Standard Report, along with an explanation of the number selected. The following items, although not all inclusive, should result in further investigation and resolution by the *person performing the analysis*. Any of the following items that are not adequately resolved by the *person performing the analysis* should be noted in the Specific Findings section of the Standard Report:
 - a. checks or wire transfers for large amounts payable to the agency or its affiliates or owners which do not appear to be fees;
 - b. large even-dollar amounts;
 - c. checks or wire transfers with no file reference;
 - d. checks or wire transfers with unusual references;
 - e. slow clearing payoffs or proceeds;
 - f. improper or unusual endorsements;
 - g. alterations to canceled checks;
 - h. checks payable to "cash" or "bearer" or to banks for cashier's checks; and unusual transfers between files and/or bank accounts.
8. Review the clearing of a representative sample of payoffs, proceeds, or other large escrow account checks or wire transfers *for the most recent monthly period available*. Trace payments to underlying source documentation. The actual number of payoffs, proceeds, or other large escrow account checks or wire transfers sampled should be disclosed in the Standard Report, along with an explanation of the number selected. Investigate instances in which such large checks or wire transfers failed to clear within 30 days of issuance. Any unusual items that are not adequately resolved by the *person performing the analysis* should be noted in the Specific Findings section of the Standard Report.
9. Review a representative sample of files for written external support of the escrow account records, e.g., signed HUD-1 settlement statements, external invoices or lender instructions. The files for review should be selected from the 3-way reconciliation review from significant untimely clearing items at steps 3 and 8

above, dormant files and open and closed files at random. The actual number of files sampled should be disclosed in the Standard Report, along with an explanation of the number selected. Any instances of inadequate external support that are not resolved by the *person performing the analysis* should be noted in the Specific Findings section of the Standard Report.

Title insurance companies/underwriters conducting *analyses* of title insurance agent escrow accounts pursuant to Virginia Code § 6.2-2.21 E 2 and 14 VAC 5-395-50 C shall make all work papers prepared in the conduct of such *analyses* available to the Bureau upon request.

The title insurance company/underwriter may condition its provision of *analysis* services in satisfaction of Virginia Code § 6.1-2.21 E 2 and 14 VAC 5-395-50 C upon the title insurance agent undertaking and providing to the title insurance company/underwriter all documentation and records reasonably deemed necessary to accomplish the foregoing *analysis* guidelines.

* An affiliated company is defined as any person that is, directly or indirectly, owned or controlled by the same person or by the same group of persons that directly or indirectly, own or control the agency. This term includes parent and subsidiaries. Control and affiliated status shall be presumed to exist if a person, directly or indirectly, owns, controls, holds with the power to vote or hold proxies, representing 10% or more of the voting securities of any other person.

**VIRGINIA CONSUMER REAL ESTATE
SETTLEMENT PROTECTION ACT ("CRESPA")
Standard Report of Escrow Accounts Maintained by Title Insurance Agents**

Title Insurance Company/Underwriter _____
 Title Insurance Agent/Agency _____
 Name of Owner/Principal Officer _____
 Agency Address _____
 Agent/Agency License # _____

Procedures

In accordance with the guidelines for "Title Insurance Company/Underwriter Analyses of Escrow Accounts Maintained by Title Insurance Agents Pursuant to CRESPA," (Title Insurance Company Name) performed the following procedures:

1. Obtained a listing of all agency bank accounts, including operating and other non-fiduciary accounts. See Schedule A.
2. Obtained a listing of all of the agency's affiliated companies. See Schedule B.
3. Reviewed and tested the agent's 3-way reconciliation(s) (bank statement to book balance to open escrow trial balance) for _____ (fill in month reviewed) for all agent escrow accounts.
4. Reviewed 3-way reconciliations for all agent escrow accounts for the three months selected. Determined the timeliness of the preparation of bank reconciliations. Determined management review and approval.
5. Reviewed the agent's _____ trial balance for all escrow accounts for "unusual items" and investigated any such items. (fill in month reviewed)
6. Reviewed all escrow account bank statements and trial balances for "unusual items" and investigated any such items.
7. Reviewed a representative sample of canceled checks and wire transfers, if any, for "unusual items" as defined in the Guidelines. (The actual number of canceled checks and wire transfers sampled should be disclosed here, along with an explanation of the number selected.)

8. Reviewed the clearing of a representative sample of _____ payoffs, proceeds, or other large escrow account checks or wire transfers. Traced payments to underlying source documentation. (The actual number of payoffs, proceeds, or other large escrow account checks or wire transfers sampled should be disclosed here, along with an explanation of the number selected.) (fill in month reviewed)
9. Reviewed a representative sample of files for written external support of the escrow account records. (The actual number of files sampled should be disclosed here, along with an explanation of the number selected.)

Specific Findings

In accordance with the guidelines for "Title Insurance Company/Underwriter Analyses of Escrow Accounts Maintained by Title Insurance Agents Pursuant to CRESPA," (Title Insurance Company Name) noted the following specific findings during the analysis of (Title Insurance Agent).

This report is intended solely for the use of (Title Insurance Agent) and the Virginia State Corporation Commission Bureau of Insurance and should not be used for any other purpose.

By signing below, I certify that I have performed the procedures above, and have noted the applicable specific findings, and the report is accurate and complete to the best of my knowledge.

 Signature of Title Insurance Company Representative

 Print Name

 Title of Representative

 Date of Report

 Telephone No.

STATE BOARD OF HEALTH AND DEPARTMENT OF MEDICAL ASSISTANCE SERVICES

Notice Seeking Public Comment on Proposed Request for Certificate of Public Need Applications

Pursuant to the authority vested in the State Board of Health and the Department of Medical Assistance Services (DMAS) by § 32.1-102.3:2 of the Code of Virginia, notice is hereby given of a proposed Request for Applications (RFA). This proposed RFA will be for certificate of public need (COPN) applications proposing capital projects which will result in an increase in the number of beds in which nursing home facility services are provided in the Commonwealth of Virginia. The RFA issuance process is outlined in the *Virginia Medical Care Facilities COPN Rules and Regulations* at 12 VAC 5-220-335.

Eligible Planning Districts and the Total Nursing Home Facility Beds Available for Authorization

In the review cycles established by this proposed RFA, the State Health Commissioner will consider requests for COPNs which propose increases in nursing home facility (NHF) beds in the following listed planning districts. COPN requests which propose increases in NHF beds in any other planning districts not identified below will not be accepted. Only COPN requests which propose a total number of NHF beds equal to or less than the total number of beds identified below as available for authorization in the planning district will be accepted for review.

1. **Planning District 1**, also known as the LENOWISCO Planning District, consisting of the counties of Lee, Scott and Wise and the city of Norton.

Total NHF Beds Available for Authorization: **90**

2. **Planning District 5**, also known as Fifth Planning District, consisting of the Counties of Alleghany, Botetourt, Craig and Roanoke and the cities of Clifton Forge, Covington, Roanoke and Salem.

Total NHF Beds Available for Authorization: **240**

3. **Planning District 22**, also known as Accomack-Northampton Planning District, consisting of the counties of Accomack and Northampton.

Total NHF Beds Available for Authorization: **30**

Basis for Selection of Eligible Planning Districts and Determination of Total NHF Beds Available for Authorization

The Nursing Home Services component (12 VAC 5-360-10 et seq.) of the Virginia State Medical Facilities Plan contains an NHF bed need forecasting method (12 VAC 5-360-40 C). This method has been employed by the Virginia Department of Health to compute a Year 2001 forecast of needed NHF beds in each of 22 planning districts. The following table displays, by planning district, these Year 2001 NHF bed need

forecasts, the current licensed and authorized inventory of NHF beds, and the net bed need forecast for Year 2001.

Planning District	Year 2001 Bed Need Forecast	Existing and Authorized Beds	Net Bed Need - Year 2001
1	669	580	89
2	599	547	52
3	1,495	1,437	58
4	875	781	94
5	2,515	2,129	386
6	1,696	1,536	160
7	1,011	901	110
8	5,072	4,231	841
9	815	702	113
10	999	1,025	26
11	1,536	1,313	223
12	1,993	1,691	302
13	804	611	193
14	753	635	118
15	4,446	3,917	529
16	808	611	197
17	455	402	53
18	590	544	46
19	1,104	1,015	89
20	5,160	4,607	553
21	2,181	1,889	292
22	423	389	34

Sources:

Virginia State Medical Facilities Plan, Nursing Home Services (12 VAC 5-360-10 et seq.)

Virginia Employment Commission (population projections, 1993 series)

1994 Virginia Nursing Home Patient Survey, A Report by Virginia's Regional Health Planning Agencies (for age-specific nursing home use rates)

Center for Quality Health Services and Consumer Protection, VDH (for bed inventory)

Consistent with the Virginia State Medical Facilities Plan (12 VAC 5-360-40 A), no planning district is considered to have a need for additional NHF beds unless the estimated average annual occupancy of all existing nonfederal Medicaid-certified NHF beds in the planning district was at least 95%

General Notices/Errata

for the most recent three years for which bed utilization has been reported to the Virginia Department of Health. (The inventory and utilization of the Virginia Veterans Care Center is excluded from consideration in the determination of NHF bed need.)

For purposes of this RFA, utilization data for reporting years 1995 to 1997 are considered to be the most recent three years. Also, the estimated average annual occupancy rates of 11 planning districts were adjusted to account for regulatory sanctions that affected the ability of 34 nursing facilities to admit Medicare and/or Medicaid patients for varying periods of time during 1996 and 1997.

Additionally, no planning district will be considered to have a need for additional nursing home beds if there are uncompleted NHF beds authorized for the planning district that will be Medicaid-certified beds. The following table displays the estimated average annual occupancy rate of Medicaid-certified NHF beds in Virginia's planning districts for the reporting years of 1995 through 1997, adjusted for regulatory sanctions, and identifies the status of these planning districts with respect to authorized but uncompleted NHF beds.

Planning District	Estimated Average Annual Occupancy Rate of Medicaid NHF Beds, 1995-1997	Authorized but Uncompleted Medicaid NHF Beds (as of 4/29/98)
1	97.5%	NO
2	93.6%	NO
3*	96.3%	YES
4*	96.2%	YES
5*	95.4%	NO
6*	94.2%	NO
7*	98.3%	NO**
8	92.9%	NO
9	94.8%	NO
10*	94.4%	NO
11*	95.1%	NO**
12	96.7%	NO**
13	95.1%	NO**
14	97.4%	YES
15*	95.6%	YES
16	97.5%	NO**
17	95.8%	NO**
18*	98.5%	NO**
19	97.0%	NO**

20*	92.5%	NO
21	94.4%	NO
22*	97.2%	NO

*The estimated average annual occupancy rate of Medicaid-certified beds in this district was adjusted to account for regulatory sanctions which may have affected utilization of facilities in this district in the 1995-1997 period.

**These planning districts were targeted for additional beds in a 1997 RFA and new beds will be authorized for these districts in 1998.

Sources:

Center for Health Statistics, VDH

Center for Quality Health Care Services and Consumer Protection, VDH

Methodological Note:

The estimated average annual occupancy rate of Medicaid-certified nursing home beds in facilities with a combination of Medicaid-certified nursing home beds and beds not certified for Medicaid was assumed to be equivalent to the average annual occupancy rate for all beds in the facility unless the average daily census of Medicaid patients reported by each facility for the annual reporting period, divided by the number of Medicaid-certified beds in the facility, yielded a higher occupancy rate, in which case this higher occupancy rate estimate was assumed.

Finally, the Virginia State Medical Facilities Plan bed need forecasting method (12 VAC 5-360-40 C) rounds bed need projections in accordance with a schedule established in the regulation. Thus, only three planning districts are identified by the standards of the *Virginia State Medical Facilities Plan* as having an "effective" forecasted need for nursing home beds by Year 2001 by virtue of (i) having a positive formula-generated need projection, (ii) having an estimated average annual occupancy rate of Medicaid-certified beds over the last three years of 95% or higher, and (iii) having no outstanding authorized NHF beds which will be Medicaid-certified beds (or no beds in the "pipeline" by virtue of being targeted in a previous RFA). Those planning districts, Planning Districts 1, 5 and 22, are profiled in the following table.

Planning District	Net Bed Need - Year 2001	Average Annual Occupancy of Medicaid Beds 1995-1997	Approved but Uncompleted Beds (as of 4/29/98)	Rounded Bed Need Forecast
1	89	97.5%	0	90
5	386	95.4%	0	240
22	34	97.2%	0	30

Projection of Potential Fiscal Impact

The Department of Medical Assistance Services projects the potential for total additional medical expenditures for services provided Medicaid recipients of approximately \$6.15

million for the fiscal year ending June 30, 2001, if all the beds included in this proposed RFA are authorized and available for occupancy by June 30, 2000. This projection is based on the following key assumptions:

Average proportion of beds filled during FY 2001	85%
Assumed Medicaid proportion of bed days	70%
Average estimated ceiling rate (direct and indirect)	\$74.05
Estimated patient pay portion	\$18.95
Estimated capital per diem of new construction	\$25
Estimated capital cost per day of converted (adult care residence) beds	\$10
Assumed mix of new construction/conversion	90/10

In addition to the annual cost for medical expenditures, DMAS estimates additional administrative costs of \$102,908 annually to process annual cost reports and complete utilization review procedures. There will be a one-time cost of approximately \$220,000 to complete on-site audits of the nursing facility cost reports for the first full year in the program and annually thereafter approximately \$50,000 to complete internal and on-site audits of the cost reports of new nursing facilities. The annual cost of utilization review for the additional beds would be \$52,908 (one analyst plus fringe benefits and travel costs).

Review Schedule

A schedule for review of COPN requests filed in response to this proposed RFA shall be included in the final RFA and will be in conformance with the provisions of 12 VAC 5-220-355.

Application Fees

The Virginia Department of Health shall collect application fees for applications requesting certificates of public need filed in response to the final RFA. The fee required for an application shall be computed as follows:

1. For projects with a capital expenditure of \$0 up to and including \$1,000,000, the application fee is the greater of 1.0% of the total capital expenditure or \$1,000;
2. For projects with a capital expenditure of \$1,000,001 up to and including \$2,000,000, the application fee is \$10,000 plus .25% of the capital expenditure above \$1,000,000;
3. For projects with a capital expenditure of \$2,000,001 up to and including \$3,000,000, the application fee is \$12,500 plus .25% of the capital expenditure above \$2,000,000;
4. For projects with a capital expenditure of \$3,000,001 up to and including \$4,000,000, the application fee is

\$15,000 plus .25% of the capital expenditure above \$3,000,000;

5. For projects with a capital expenditure of \$4,000,001 up to and including \$5,000,000, the application fee is \$17,500 plus .25% of the capital expenditure above \$4,000,000;

6. For projects with a capital expenditure of \$5,000,000 or more, the application fee is \$20,000.

No application will be deemed to be complete for review until the required application fee is paid.

DEPARTMENT OF MEDICAL ASSISTANCE SERVICES

The Department of Medical Assistance Services hereby gives notice to all interested parties that the following discussion relates to its revised final regulations, currently in extended comment period, regarding Specialized Care Services Provider and Recipient Criteria, as published in 14:26 VA.R. 4251-4266 September 14, 1998, which amended 12 VAC 30-20-170, 12 VAC 30-50-160, 12 VAC 30-60-40, 12 VAC 30-60-320, 12 VAC 30-60-340, 12 VAC 30-90-264, and 12 VAC 30-90-290. DMAS is not conducting any public hearings about this final regulation but is accepting written comments until October 14, 1998.

Title of Revised Final Regulation: Specialized Care Nursing Facility Services: Provider and Recipient Criteria

Statutory Authority: § 32.1-325 of the Code of Virginia

Director's Adoption: August 26, 1998

Additional Public Comment Period: September 14 - October 14, 1998

Proposed Effective Date: October 15, 1998

Agency Contact: Regina Anderson-Cloud, Long-Term Care Division, Department of Medical Assistance Services, 600 East Broad Street, Suite 1300, Richmond, VA 23219, (804) 371-6448.

Copies of the regulation may be obtained from Victoria P. Simmons, Regulatory Coordinator, Department of Medical Assistance Services 600 East Broad Street, Suite 1300, Richmond, VA 23219, (804) 371-8850.

Basis and Authority: Section 32.1-324 of the Code of Virginia authorizes the Director of the Department of Medical Assistance Services (DMAS) to administer and amend the Plan for Medical Assistance according to the Board of Medical Assistance Services' requirements. On December 19, 1997, the director approved the initiation of a public comment period for the proposed regulations. Articles 2 (§ 9-6.14:7.1 et seq. of the Code of Virginia) of the Administrative Process Act requires agencies to adopt and amend regulations subject to public notice and comment when the action being taken does not meet one of the statutory exemptions.

General Notices/Errata

Subsequent to an emergency adoption action, the agency initiated the public notice and comment process as contained in Article 2 of the APA. The emergency regulation became effective on August 14, 1997. Section 9-6.14:4.1 C of the Code of Virginia requires the agency to file the Notice of Intended Regulatory Action no later than 60 days after the effective date of the emergency regulation if it intends to promulgate a permanent replacement regulation. The Notice of Intended Regulatory Action for this regulation was filed with the Virginia Register on December 31, 1996.

Chapter 924 of the Acts of the Assembly, Item 322.D.2.a, required DMAS to promulgate regulations, to be effective July 1, 1997, "... to implement other appropriate changes in service limits, program category criteria, utilization control methods, and provider contract standards consistent with the recommendations of the study."

Purpose: The purpose of this proposal is to provide opportunity for further public comment on DMAS' amendments to its specialized care program updating of the definitions of provider and recipient criteria. DMAS is initiating an additional 30-day period of comment on these revised final regulations.

Substance and Analysis: The sections of the state plan affected by this action are Attachment 4.19 C - Basis of payment for reserving beds during a recipient's absence from an inpatient facility (12 VAC 30-20-170); Attachment 3.1 C - Standards Established and Methods Used to Assure High Quality Care: Utilization Control: Nursing Facilities (12 VAC 30-60-40); Supplement 1 to Attachment 3.1 C - Adult specialized care criteria (12 VAC 30-60-320) and Pediatric and adolescent specialized care criteria (12 VAC 30-60-340); Supplement 1 to Attachment 3.1 A&B - Home health services (12 VAC 30-50-160); the Nursing Home Payment System (12 VAC 30-90-264); and Supplement 3 to the Nursing Home Payment System (12 VAC 30-90-290).

On October 1, 1991, the Department of Medical Assistance Services (DMAS) implemented a new reimbursement system for nursing facilities based on patient care intensity and a new level of service called specialized care. Specialized care was described as care required by residents who have long-term health conditions which demand close medical supervision, 24-hour licensed nursing care, and specialized services or equipment. For payment purposes, services for specialized care residents were grouped into four categories: comprehensive rehabilitation, complex care, ventilator dependent, and AIDS.

The specialized care program was DMAS' response to the need for access to care and the appropriate provision of services to those Medicaid recipients who required more intensive resources than average nursing facility residents. The DMAS *Virginia Medicaid Nursing Home Manual* states that specialized care includes residents "...who have needs that are so intensive or non-traditional that they cannot be adequately captured by a patient intensity rating system, e.g., ventilator dependent or AIDS patients."

Expenditures, utilization, and provider participation have increased dramatically since the inception of the specialized

care program in 1991. After careful analysis of the specialized care program, DMAS reported that the actual costs to providers of specialized care services appeared to be well below the flat rates that the providers were being reimbursed. Recommendations for reductions in the specialized care rates were submitted to the General Assembly. Hearings and discussions ensued between the legislature, DMAS, and the provider community which resulted in the legislature mandating a formal study of the specialized care program.

The study group that was organized to evaluate the specialized care program included DMAS staff, representatives from industry trade associations (including the Virginia Health Care Association and the Virginia Hospital and Healthcare Association), and supporting staff from the Center for Health Policy Studies, commissioned by DMAS. The study group produced a report providing a comprehensive review of the existing specialized care program. The report examines resident and provider criteria governing participation in the specialized care program, provides an overview of DMAS Utilization Review (UR) and Control guidelines and processes for specialized care providers, reviews Medicare and DMAS specialized care payment policies and issues for nursing facility services, and describes the new payment methodology developed for the specialized care program.

The report presents DMAS' recommendations for a collection of changes in the specialized care program. These recommendations include changes in specialized care categories and payment methodologies, and clarifications and changes in specialized care resident and provider criteria. In December 1996, DMAS implemented emergency regulations for the payment methodologies based upon two broad recommendations from the report. Those emergency regulations, which have now been superseded by permanent, final regulations, addressed the recommendations in the report for changes in specialized care payment methodologies and an elimination of the existing AIDS category of care due to nonutilization. The remaining recommendations from the report primarily addressed changes in specialized care resident and provider criteria.

A. Recipient Medical Eligibility Criteria

The medical eligibility criteria for the specialized care program currently are established in two sets of criteria. There is a distinct set of medical criteria for individuals over the age of 21. Those under the age of 21 are classified as pediatric or adolescent and fall into a separate category. Both sets of criteria require further medical criteria definition. The criteria have not been updated since the implementation of the program in 1991. As services have been studied and as utilization has increased resulting in great diversity among the recipients served by the program, a need to provide more concrete service definitions in some areas has been demonstrated. The proposed changes in category areas of comprehensive rehabilitation, mechanical ventilation, and complex health care will better assure that recipients who require a higher acuity of care will be routed to and placed in specialized care when appropriate. The changes in the

criteria will also assist in deterring inappropriate utilization of specialized care reimbursement.

B. Contract Approval

The provider criteria have not been updated or significantly revised since the implementation of the program in 1991. As the program history has been studied and as utilization has increased, DMAS has determined that provider standards must be more specifically designated in regulation so that the medically compromised recipients receiving specialized care services can be assured that contracting specialized care providers maintain all required services and are able to provide quality services. To address these concerns, these regulations seek to apply standards to specialized care contract approval.

The contract approval process will ensure that providers seeking specialized care contracts can provide an adequate quality of nursing facility care, as well as meet the scope of service provisions for specialized care. The criteria will designate quantifiable standards to clearly delineate acceptable provider participation requirements which are supported within a provider's history of administering institutional health care services. DMAS has piloted these criteria standards since the program implementation in 1991, with the exception of the references to the Health Care Financing Administration's (HCFA) sanctioning guidelines, which were implemented as applicable to all nursing facilities in 1996. Prior to the federal changes in the nursing facility guidelines, DMAS reviewed the now-obsolete level classification system formerly mandated by HCFA for nursing facility surveys. With the changes that HCFA implemented in the sanctioning and deficiency classification matrix in 1996, DMAS deemed it necessary to develop regulatory approval standards that more accurately utilized the current HCFA classifications.

C. Removal of the Preauthorization Requirements for Specialized Care Admission

Since the date of enactment of the emergency regulations proposing changes to the provider and recipient criteria in 1997, DMAS has studied the issue of whether it should continue to preauthorize admissions to the specialized care program. When the program was initiated in 1991, DMAS instituted preauthorization requirements to ease the transition into this new program area and to help educate providers regarding appropriate interpretation of program criteria. Based on the established experience of DMAS in providing this level of care, DMAS foresees no need to continue preauthorization for this program. With the clarifications that have been made in the current proposed final regulations, providers now have a solid regulatory basis for criteria interpretation as well as years of experience in interpreting admission requirements. Therefore, DMAS has removed the preauthorization requirement from this regulatory package. This exclusion was not part of the regulatory language that was subject to initial public comment. However, in the additional final comment period pursuant to the last posting of the regulations, DMAS received no comments related to the removal of the preauthorization requirements.

To assure that providers would not feel adversely affected by this change, DMAS conducted a telephone survey of all participating specialized care providers during March of 1998. The survey asked providers if they felt that the elimination of the preauthorization requirement would be a "program enhancement" from the providers' point of view. Of 43 providers surveyed, 34 agreed that this change would enhance the program and create expedited admission for specialized care recipients. Six providers felt that this process would not be a program enhancement and stated they would prefer the "security" of the preauthorization process. Of the remaining providers that responded to the telephone survey, two had "mixed" opinions about whether it would be an enhancement or not and one provider declined to comment. Seven contracting providers did not respond to DMAS' attempts to conduct the survey via telephone. Based on this study, as well as DMAS experience with providers, no adverse circumstances are anticipated in the elimination of this requirement.

Also during provider discussions around the issue of the specialized care study, it was brought to DMAS' attention that its state plan language providing for reserving beds in long-term care facilities for recipients during their temporary absences from such facilities was not clear. In response to this observation, DMAS has added clarifying language to Attachment 4.19-C (12 VAC 30-20-170).

Issues: The changes will be advantageous to providers and recipients because program criteria and requirements will be more specifically defined. It is anticipated that this will result in greater continuity in service provision as well as lead to ensuring quality in the services provided.

A. Recipient Criteria

Providers may voice concerns regarding added parameters and limitations inserted into the recipient criteria for medical eligibility for the program. However, the specialized care study recommended the addition of parameters in certain areas as well as the clarification of some criteria standards. These recommendations were made as a result of identified lack of clarity and specification in certain areas. In addition, some definitions and parameters were added due to concerns voiced by providers over time that certain areas required further clarification. For example, such concerns prompted the addition of quantifiable standards for reimbursement retractions in the comprehensive rehabilitation category of care.

While DMAS does seek to add parameters and limitations to some aspects of recipient criteria, these recommendations are made after careful study and cooperative work and comment with the nursing home trade associations. These standards are felt to most accurately represent the needs of the program based on the program's historical experience as well as based on provider feedback from over the years.

A very small number of providers may also oppose the new change eliminating the requirement for DMAS preauthorization of services. However, the DMAS survey data provides strong evidence that the majority of providers will see this change as a program enhancement. In addition,

General Notices/Errata

DMAS foresees no negative impact upon recipients in making this change. In fact, with the change, recipients will have more ready access to specialized care in that they will not have to wait for DMAS approval prior to being transferred to a contracting provider.

B. Provider Criteria

Some providers may also voice concern about the inclusion of the provider approval standards into the regulations. However, the nursing home trade associations did not voice concern over the inclusion of provider approval standards during the course of discussions with them during and in follow-up to the specialized care study. A need for clear specifications is deemed necessary for adequate administration of the program. These changes will benefit providers in that clear, quantifiable criteria will be available to assist in provider decision-making about whether to apply for participation in the program. DMAS has a need for such standards because this level of care is geared toward a medically fragile population with care needs that are generally above the acuity and resource utilization of the average nursing facility level of care. If a provider cannot meet minimum general standards for nursing facilities and demonstrate good compliance over time, DMAS would be concerned about such a provider attempting to provide care to medically fragile recipients with greater needs. The proposed regulations incorporate approval criteria from standards of the Virginia Department of Health, the Long-Term Care Ombudsman Program, and DMAS.

Executive Order 15 (94) Review: There were no comments received from either the Board of Medical Assistance Services or the public on the subject of specialized care services during this regulatory review.

Summary of Public Comments Received: DMAS' proposed regulations were initially published in the March 2nd *Virginia Register* for their public comment period from March 2 - May 1, 1998. Comments were received from the "Virginia Pressure Ulcer Quality Initiative Task Force."

The task force structured their comments around the wound care recommendations that were originally suggested in the specialized care study which was published in November 1996. However, the task force requested that their comments be considered as relevant and in response to this regulatory action as it relates to wound care. Comments that were in direct response to study language that was never promulgated or that are considered general comments of the task force which have no bearing on the specialized care program are not relevant to this regulatory package. However, comments that have direct relevance to the provision of wound care are summarized as follows:

Criteria limitations: The task force recommended that DMAS consider expanding coverage requirements for the existing specialized care program to include a wider range of pressure ulcers than is currently covered in the program criteria. **Response:** Due to criteria coverage in other Medicaid-funded programs such as the durable medical equipment (DME) program, DMAS would have a "comparability of service" violation under 42 CFR 440.240(b)

if it expanded coverage in one program area and did not expand coverage in other program areas. Due to comparability of service issues, these changes cannot be made at this time. However, more importantly, DMAS cannot make changes that would expand the current wound care program due to concerns that are explained later in this regulatory summary.

Staff training requirements: The task force recommended that providers participating in the specialized care wound care program be required to have "on staff, or readily available to them, a qualified clinical expert that can help oversee the appropriate treatment of wound care." **Response:** Nursing facility providers are already required under federal and state licensing and certification statutes to provide medical care of a level of complexity and expertise that adequately meets the needs of the resident population. Additional staffing expertise requirements of the Medicaid program are therefore not viewed as necessary. The treatment of wounds such as pressure ulcers is a common treatment condition in the geriatric and long-term care populations. The oversight of quality of care issues pursuant to 42 CFR 483 is the primary responsibility of the Virginia Department of Health.

Therapeutic sleep surfaces: The Task Force recommended that DMAS expand Medicaid reimbursement for "therapeutic sleep surfaces" (also known as specialty treatment beds) to include reimbursement for "all Medicaid certified nursing facilities" to cover pressure ulcers of Stage II or greater. **Response:** Currently, reimbursement is only directly available to contracting specialized care providers for such specialty beds. While DMAS cannot at this time consider an expansion of the coverage requirements to include a greater range of wounds, DMAS proposes to make the following changes to the existing regulations in response to this public comment:

- (1) Elimination of the wound care subcategory of the complex health care category of specialized care; and
- (2) Expansion of direct means of reimbursement for specialty treatment beds for residents of all Medicaid participating nursing facilities, not just to those providers involved in specialized care services.

DMAS proposes the two above changes in response to public comment as well as ongoing research conducted by DMAS in follow-up to the specialized care study of 1996. In the final comment period, some commenters voiced concern that it appeared as if the task force suggested the elimination of the subcategory of wound care from the specialized care program. The task force did not make such a recommendation in its written comments as this was DMAS' initiative. Additional issues that support making this change are detailed below.

The changes to eliminate wound care as a component of specialized care and to add coverage for special beds for wound care as covered durable medical equipment necessitates changes to three regulations that were not originally included in this regulatory package: 12 VAC 30-50-

160 (DME), 12 VAC 30-90-264 (Specialized care services), and 12 VAC 30-90-290 (Cost reimbursement limitations).

DMAS received requests from 32 individuals for additional public comment on this revised final regulation for Specialized care Services: Provider and Recipient Criteria. DMAS is initiating an additional 30 days for public comment on these revised final regulations.

In addition, providers also requested clarification of reimbursement for DME specialty beds policy which DMAS is providing in future communication to affected providers. DMAS has also requested informal comments from providers concerning its DME policy. Any changes to policy based on comments will be communicated to providers in a timely manner.

Wound care dressings: Avante Corporation commenters also stated that the DMAS specialized care wound care criteria required providers to apply at least three dressing changes per day. Their issue was that this may not be an acceptable treatment practice for some wounds. **Response:** Since program implementation in 1991, DMAS criteria have required that a physician order kinetic bed therapy OR three-times-per-day dressing changes for stage IV pressure ulcers. To clarify this distinction, the emergency regulations of 1997 were further clarified to highlight this treatment choice. The regulations state the following in 12 VAC 30-60-320 in regard to wound care:

“These wounds must require debridement, irrigation, packing, etc., more than two times per day or ongoing consistent utilization of kinetic therapy beds as ordered by the physician in combination with other appropriate, aggressive wound care treatment.”

The regulation clearly allows the physician the treatment choice of whatever aggressive treatment is effective, including any dressing regardless of frequency of changes, so long as the dressing is considered “aggressive wound care treatment.” This provision has always been in the regulations and was further clarified with the above wording in the 1997 emergency regulations changes.

Supporting Issues:

Virginia ranks third in the nation (behind Washington, D.C., and California) in the prevalence of pressure ulcers (OSCAR Health Care Financing Administration Census Data, 9/29/97) that develop in nursing facilities' patients. The existing specialized care wound care subcategory provides no incentive for providers to aggressively treat pressure ulcers in that providers are given inflated reimbursement as long as a patient continues to demonstrate the worst stage of pressure ulcer (stage IV). DMAS has noted that some specialized care recipients have been receiving treatment for pressure ulcers for as long as five consecutive years.

DMAS studies have demonstrated based on 1997 data that pressure ulcer patients receiving care at the basic nursing facility per diem rate who required wound care for stage IV pressure ulcers healed more than twice as quickly on average than similar patients receiving care at a higher reimbursement rate in the specialized care program. In the

1997 study sample, the average recovery time for nursing facility residents treated at the basic nursing facility per diem was 75.25 days, while similar residents required an average of 150.05 days in the specialized care wound care program.

However, clinical studies such as Greer et al. (1988) have found that when wounds are aggressively treated and receive specialty bed treatment, they can be effectively healed within an average of 80 days from treatment onset. The current specialized care wound care program also creates an adverse incentive for the development of new pressure ulcers in nursing facilities because the program “rewards” facilities with inflated reimbursement when new severe pressure ulcers develop.

The 1996 specialized care study presented an option to discontinue the specialized care wound care subcategory of care and to move to providing direct reimbursement for specialty treatment beds for residents of all Medicaid certified nursing facilities. At the time of the study, it was noted that of the states surveyed only one was providing a similar reimbursement mechanism for special reimbursement for wound care. However, after the study, DMAS opted to pursue further research regarding reimbursement for wound care.

Research into the actual costs of providing specialized wound care has demonstrated that Virginia's program may be overpaying providers and that the nursing and treatment costs associated with treating wounds of all intensity stages averages \$3.74 per ulcer per day without considering the costs of specialty beds [Frantz et al. (1995)]. The mean cost of treating stage III and IV ulcers was \$4.46 and \$6.03 per ulcer per day, respectively. According to the same research, an additional cost of approximately \$45 to \$70 per day is required to provide specialty bed treatment. Virginia's specialized care cost data demonstrates that providers are averaging approximately \$51 per day for specialty bed rental at non-Medicaid rates. However, providers are being paid a wound care per diem of \$285.46 based on 1997 data. This rate includes the cost of specialty beds. The current average per diem rate for nursing facility care is \$81 per day.

Given the extreme cost differences in what research has demonstrated to be necessary to provide wound care to pressure ulcer patients and what is being paid in specialized care, and given the tremendous problem the Commonwealth of Virginia has with the prevalence of pressure ulcers in nursing facilities, it is evident that the payment incentive of the wound care program in specialized care must be removed. However, DMAS recognizes the need to provide a direct means of reimbursement for specialty treatment beds. The proposed changes account for a direct means of reimbursement for rental of DME equipment for specialty beds in nursing facilities. Reimbursement will be made directly to DME vendors to provide beds in nursing facilities for patients meeting the DME wound care criteria. This bed payment is intended to eliminate incentives to allow wounds to worsen to the point of meeting specialized care criteria, thus permitting the nursing facility to qualify for the increased reimbursement. Many studies as well as the Agency for Health Care Policy and Research recognize the benefit in

General Notices/Errata

treatment and expedited healing that therapeutic sleep surfaces can provide to residents with extreme wounds.

It is very important to note, however, that the regulatory change does not limit services to recipients. Nursing facilities are capable of providing wound care to stage IV pressure ulcers at the nursing facility level of care via the nursing facility per diem with the exception of the need for reimbursement for specialty beds. Facilities who do not have specialized care contracts have been providing stage IV wound care within the basic nursing facility per diem since 1991, and have traditionally provided wound care as a component of the basic nursing facility per diem. In fact, during calendar year 1997, an estimated 224 patients were treated for stage IV pressure ulcers that would meet the current DME criteria for specialty beds with the Medicaid nursing facility per diem when compared to 125 who were treated in specialized care facilities. (Interim study estimates of this number of patients placed the number at 144. Upon completion of Medicaid study data, this number was found to be 224.) The number of patients treated with the nursing facility per diem is significant because the current Medicaid DME admission criteria are more stringent than the specialized care wound care admission criteria. Therefore, it can be assumed that a greater number of patients than 224 were actually treated for stage IV pressure ulcers using only the nursing facility per diem. (The DME criteria currently require at least one stage IV ulcer in addition to another ulcer before criteria are met, while the specialized care criteria are less restrictive, requiring only a stage IV ulcer.)

By making the regulatory change, the reimbursement becomes equal for the same type of care across facilities and allows residents of Medicaid facilities who do not participate in the specialized care program to have direct access to specialty treatment beds upon physician's order consistent with DMAS' durable medical equipment criteria. As a condition of participation in the Medicaid program, nursing facilities are required by 42 CFR 483.25 to provide both treatment and prevention for pressure ulcers.

Case documentation has revealed that poor resident outcomes appear to have occurred with some residents over time. Since DMAS can now demonstrate that wounds can be cared for at the nursing facility level of care provided that specialty beds are reimbursed, the utility of the specialized care wound care program can no longer be substantiated. This is especially true in light of recent research findings and the public comment received as well as in consideration of the severity of the problem with the immense prevalence of pressure ulcers in the Commonwealth.

These changes may produce a cost savings to the Commonwealth. Fiscal impact is discussed below.

Fiscal/Budget Impact:

There are no localities which are uniquely affected by these regulations as they apply statewide. The changes proposed for the provider and recipient criteria will not financially impact providers or recipients, except in the case of wound care which will be discussed separately. By adding more

specific parameters to some recipient criteria areas, a small, yet undetermined, cost savings may be realized by DMAS.

In regard to wound care, it is anticipated that the proposed elimination of inflated specialized care payments made to nursing facilities providing wound care while providing therapeutic sleep surfaces to nursing facility residents based on the DME program criteria may result in cost savings to the Commonwealth. In 1997, approximately \$4.3 million was paid to nursing facilities providing specialized care for wound care treatment of stage IV pressure ulcers. These payments were made to 29 providers with the majority of payments being made to a small group of providers. Yearly provider payments for wound care among the 29 providers ranged from \$509,746 to \$9,902. These payments included the cost of providing specialty beds. During calendar year 1997, 125 residents were served in the wound care program statewide. Due to the informal comment being received concerning DMAS policy for durable medical equipment relating to specialty treatment beds, DMAS is unsure whether DME policy changes would significantly impact any costs saved by the elimination of specialized care wound care payments.

However, these changes will reduce reimbursement to the 29 providers currently providing specialized care wound care. Research data clearly demonstrate that such costs can be managed within the nursing facility per diem if the specialty beds are provided under a separate reimbursement source. DMAS views this as having a positive impact on residents and the larger nursing facility provider population in that direct reimbursement will be provided for specialty beds. The proposed regulations are anticipated to possibly produce some cost savings that cannot be anticipated at this time or result in cost neutrality related to the outcome of informal comment being received on the DME specialty bed criteria.

Forms: No new forms will be required for implementation of this regulation.

Evaluation: The Department of Medical Assistance Services routinely monitors the Medicaid Program to ensure compliance with legislative mandates.

STATE WATER CONTROL BOARD

Proposed Consent Special Order Town of Grottoes

The State Water Control Board proposes to enter into a Consent Special Order with the Town of Grottoes to resolve violations of the State Water Control Law and regulations at Grottoes' sewage treatment plant in Rockingham County. Grottoes discharges treated wastewater into the South River under authority of a VPDES permit. On February 26, 1998, DEQ conducted an inspection of Grottoes' temporary sludge holding/drying pits and documented that these pits were flooded from recent heavy rains resulting in the loss of sludge to state waters. During this inspection, DEQ also documented problems with the facility's laboratory records and the testing and reporting of effluent.

The proposed Consent Special Order settles the outstanding Notice of Violation and incorporates a schedule of compliance to ensure proper staffing, operation, maintenance, and recordkeeping for the facility, and to properly collect, handle and dispose of the sludge from the temporary holding/drying pits. The order also assesses a civil charge for the violations.

The board will receive written comments relating to the proposed Consent Special Order for 30 days from the date of publication of this notice. Comments should be addressed to Steven W. Hetrick, Department of Environmental Quality, Post Office Box 1129, Harrisonburg, Virginia 22801, and should refer to the Consent Special Order.

The proposed order may be examined at the Department of Environmental Quality, Valley Regional Office, 4411 Early Road, Harrisonburg, Virginia 22801. A copy of the order may be obtained in person or by mail from this office.

Proposed Consent Special Order Amendment Town of Strasburg

The State Water Control Board proposes to enter into a Consent Special Order Amendment with the Town of Strasburg (Strasburg). The parties have agreed to the terms of a Consent Special Order Amendment establishing a revised schedule of compliance for completing a sewer system evaluation survey (SSES).

Strasburg operates a municipal sewage treatment plant under a VPDES permit authorizing discharge of treated sewage into Town Run, a tributary of the North Fork of the Shenandoah River.

Strasburg has experienced problems with its sewage collection system related to the inflow and infiltration (I/I) of stormwater and groundwater into the system. This I/I causes frequent overflows of raw sewage from collection system manholes with occasional discharge of untreated sewage into Town Run.

A May 1996 Consent Special Order Amendment requires Strasburg to complete an SSES to identify I/I problem areas, then to develop a plan and schedule to correct the problem areas. Strasburg has failed to comply with the May 1996 Consent Special Order Amendment. The proposed Consent Special Order Amendment would establish a revised schedule for Strasburg's completion of the SSES and correction of I/I. The proposed Consent Special Order Amendment would also assess a civil charge for failure to comply with the 1996 order.

The board will receive written comments relating to the proposed Consent Special Order Amendment for 30 days from the date of publication of this notice. Comments should be addressed to Edward A. Liggett, Department of Environmental Quality, Post Office Box 1129, Harrisonburg, Virginia 22801, and should refer to the Consent Special Order Amendment. The proposed order may be examined at the Department of Environmental Quality, Valley Regional Office, 4411 Early Road, Harrisonburg, Virginia 22801. A

copy of the order may be obtained in person or by mail from this office.

Proposed Consent Special Order Ticonderoga Farms, Inc., and SWPP Development Corporation

The State Water Control Board proposes to issue a Consent Special Order to the Ticonderoga Farms, Inc. (TFI) and SWPP Development Corp. (SWPP) regarding TFI's Yard Waste Management Facility located in Loudoun County, Virginia.

The proposed order provides, among other things, that TFI and SWPP prevent any discharge of leachate or other pollutant from the facility into state waters; cease accepting yard waste at the facility by September 1, 1998; submit a leachate management plan and a closure plan for the facility; and complete final closure of the facility by December 1, 1999. TFI and SWPP have agreed to the issuance of the order and to payment of a civil charge.

On behalf of the board, the Department of Environmental Quality's Northern Virginia Regional Office will receive written comments relating to the order through November 11, 1998. Please address comments to: Elizabeth Anne Crosier, Northern Virginia Regional Office, Department of Environmental Quality, 13901 Crown Court, Woodbridge, Virginia 22193. Please write or visit the Woodbridge address, or call (703) 583-3886, in order to examine or to obtain a copy of the order.

Proposed Consent Special Order Valley View Mobile Home Court

The State Water Control Board proposes to enter into a Consent Special Order with Valley View Mobile Home Court to resolve violations of the State Water Control Law and regulations at Valley View's sewage treatment plant in Rockingham County. Valley View discharges treated wastewater into Dry Run under authority of a VPDES permit. Since approximately April 1992, the Valley View sewage treatment plant has violated certain of its permit effluent limitations. Valley View has also failed to comply with the permit conditions which required an evaluation of the lagoon permeability and upgrade to meet final effluent limitations for ammonia-nitrogen. DEQ has also found Valley View's sewage treatment facility records were not being accurately reported on the Discharge Monitoring Report and that the effluent testing was not being properly performed and reported.

The proposed Consent Special Order settles outstanding Notices of Violation and incorporates a schedule of compliance to ensure the proper oversight, operation and maintenance of the facility; to evaluate any future effluent violations; and to initiate any further corrective actions, plant modifications or upgrades necessary in order to gain consistent compliance with all the permit requirements. The

General Notices/Errata

proposed Consent Special Order also contains a civil charge for the violations.

The board will receive written comments relating to the proposed Consent Special Order for 30 days from the date of publication of this notice. Comments should be addressed to Steven W. Hetrick, Department of Environmental Quality, Post Office Box 1129, Harrisonburg, Virginia 22801, and should refer to the Consent Special Order.

The proposed order may be examined at the Department of Environmental Quality, Valley Regional Office, 4411 Early Road, Harrisonburg, Virginia 22801. A copy of the order may be obtained in person or by mail from this office.

Proposed Consent Special Order Virginia Metalcrafters, Inc.

The State Water Control Board proposes to enter into a Consent Special Order with Virginia Metalcrafters, Inc., to address toxicity contamination present in the facility's stormwater discharge. The proposed order supersedes a previous order issued to the company in 1997 for this same purpose.

Virginia Metalcrafters, Inc., discharges stormwater collected at its Waynesboro facility into an unnamed tributary of the South River. The stormwater is discharged from four separate outfalls and is regulated under a VPDES permit. The VPDES permit includes provisions to address the toxicity known to be present in the stormwater discharged from one of the four outfalls. The 1997 order required the company to complete specific modifications to the facility thought to be the source of the toxicity. The proposed order requires the company to continue to monitor the stormwater discharge for toxicity and to institute additional corrective measures if the toxicity contamination continues to be present in the discharge. The proposed order would require the company to comply with the VPDES permit's toxicity limit by July 1, 2000.

The board will receive written comments relating to the proposed Consent Special Order for 30 days from the date of publication of this notice. Comments should be addressed to Edward A. Liggett, Department of Environmental Quality, Post Office Box 1129, Harrisonburg, Virginia 22801, and should refer to the Consent Special Order.

The proposed order may be examined at the Department of Environmental Quality, Valley Regional Office, 4411 Early Road, Harrisonburg, Virginia 22801. A copy of the order may be obtained in person or by mail from this office.

VIRGINIA CODE COMMISSION

Notice to State Agencies

Mailing Address: Virginia Code Commission, 910 Capitol Street, General Assembly Building, 2nd Floor, Richmond, VA 23219. You may FAX in your notice; however, we ask that

you FAX two copies and do not follow up with a mailed copy. Our FAX number is: (804) 692-0625.

Forms for Filing Material for Publication in *The Virginia Register of Regulations*

All agencies are required to use the appropriate forms when furnishing material for publication in *The Virginia Register of Regulations*. The forms may be obtained from: Virginia Code Commission, 910 Capitol Street, General Assembly Building, 2nd Floor, Richmond, VA 23219, telephone (804) 786-3591.

Internet: Forms and other *Virginia Register* resources may be printed or downloaded from the *Virginia Register* web page:
<http://legis.state.va.us/codecomm/register/regindex.htm>

FORMS:

NOTICE of INTENDED REGULATORY ACTION - RR01
NOTICE of COMMENT PERIOD - RR02
PROPOSED (Transmittal Sheet) - RR03
FINAL (Transmittal Sheet) - RR04
EMERGENCY (Transmittal Sheet) - RR05
NOTICE of MEETING - RR06
AGENCY RESPONSE TO LEGISLATIVE OBJECTIONS
- RR08



Statement of Ownership, Management, and Circulation
(Required by 39 USC 3685)

1. Publication Title The Virginia Register of Regulations		2. Publication Number 00-1831		3. Filing Date Sept. 25, 1998	
4. Issue Frequency Biweekly with quarterly index		5. Number of Issues Published Annually 30		6. Annual Subscription Price \$100.00	
7. Complete Mailing Address of Known Office of Publication (Not printer) (Street, city, county, state, and ZIP+4) Virginia Code Commission, General Assembly Bldg., 2nd Fl. 910 Capitol Street, Richmond, VA 23219				Contact Person Jane Chaffin Telephone 804-786-3591	
8. Complete Mailing Address of Headquarters or General Business Office of Publisher (Not printer) Virginia Code Commission, General Assembly Building, 2nd Floor, Richmond, VA 23219					
9. Full Names and Complete Mailing Addresses of Publisher, Editor, and Managing Editor (Do not leave blank)					
Publisher (Name and complete mailing address) Virginia Code Commission, Commonwealth of Virginia, General Assembly Bldg., 2nd Floor, 910 Capitol Street, Richmond, VA 23219					
Editor (Name and complete mailing address) Jane Chaffin, Registrar of Regulations, Virginia Code Commission, General Assembly Bldg., 2nd Fl., 910 Capitol Street, Richmond, VA 23219					
Managing Editor (Name and complete mailing address) Jane Chaffin, Registrar of Regulations, Virginia Code Commission, General Assembly Bldg., 2nd Fl., 910 Capitol Street, Richmond, VA 23219					
10. Owner (Do not leave blank. If the publication is owned by a corporation, give the name and address of the corporation immediately followed by the names and addresses of all stockholders owning or holding 1 percent or more of the total amount of stock. If not owned by a corporation, give the names and addresses of the individual owners. If owned by a partnership or other unincorporated firm, give its name and address as well as those of each individual owner. If the publication is published by a nonprofit organization, give its name and address.)					
Full Name		Complete Mailing Address			
Virginia Code Commission		General Assembly Building			
(Nonprofit State Agency)		910 Capitol Street, 2nd Floor			
		Richmond, VA 23219			
11. Known Bondholders, Mortgagees, and Other Security Holders Owning or Holding 1 Percent or More of Total Amount of Bonds, Mortgages, or Other Securities. If none, check box <input checked="" type="checkbox"/> None					
Full Name		Complete Mailing Address			
None					
12. Tax Status (For completion by nonprofit organizations authorized to mail at special rates) (Check one) The purpose, function, and nonprofit status of this organization and the exempt status for federal income tax purposes: <input checked="" type="checkbox"/> Has Not Changed During Preceding 12 Months <input type="checkbox"/> Has Changed During Preceding 12 Months (Publisher must submit explanation of change with this statement)					

General Notices/Errata

13. Publication Title Virginia Register of Regulations		14. Issue Date for Circulation Data Below September 14, 1998	
15. Extent and Nature of Circulation		Average No. Copies Each Issue During Preceding 12 Months	Actual No. Copies of Single Issue Published Nearest to Filing Date
a. Total Number of Copies (Net press run)		700	700
b. Paid and/or Requested Circulation	(1) Sales Through Dealers and Carriers, Street Vendors, and Counter Sales (Not mailed)	N/A	N/A
	(2) Paid or Requested Mail Subscriptions (Include advertiser's proof copies and exchange copies)	525	524
c. Total Paid and/or Requested Circulation (Sum of 15b(1) and 15b(2)) ▶		525	524
d. Free Distribution by Mail (Samples, complimentary, and other free)		105	105
e. Free Distribution Outside the Mail (Carriers or other means)		20	20
f. Total Free Distribution (Sum of 15d and 15e) ▶		125	125
g. Total Distribution (Sum of 15c and 15f) ▶		650	649
h. Copies not Distributed	(1) Office Use, Leftovers, Spoiled	50	51
	(2) Returns from News Agents	N/A	N/A
i. Total (Sum of 15g, 15h(1), and 15h(2)) ▶		700	700
Percent Paid and/or Requested Circulation (15c / 15g x 100)		80.7	80.7
16. Publication of Statement of Ownership <input checked="" type="checkbox"/> Publication required. Will be printed in the <u>10/12/98</u> issue of this publication. <input type="checkbox"/> Publication not required.			
17. Signature and Title of Editor, Publisher, Business Manager, or Owner <i>Jane Chaffin, Registrar of Regulations</i>		Date Sept. 25, 1998	

I certify that all information furnished on this form is true and complete. I understand that anyone who furnishes false or misleading information on this form or who omits material or information requested on the form may be subject to criminal sanctions (including fines and imprisonment) and/or civil sanctions (including multiple damages and civil penalties).

Instructions to Publishers

- Complete and file one copy of this form with your postmaster annually on or before October 1. Keep a copy of the completed form for your records.
- In cases where the stockholder or security holder is a trustee, include in items 10 and 11 the name of the person or corporation for whom the trustee is acting. Also include the names and addresses of individuals who are stockholders who own or hold 1 percent or more of the total amount of bonds, mortgages, or other securities of the publishing corporation. In item 11, if none, check the box. Use blank sheets if more space is required.
- Be sure to furnish all circulation information called for in item 15. Free circulation must be shown in items 15d, e, and f.
- If the publication had second-class authorization as a general or requester publication, this Statement of Ownership, Management, and Circulation must be published; it must be printed in any issue in October or, if the publication is not published during October, the first issue printed after October.
- In item 16, indicate the date of the issue in which this Statement of Ownership will be published.
- Item 17 must be signed.

Failure to file or publish a statement of ownership may lead to suspension of second-class authorization.

ERRATA

VIRGINIA CODE COMMISSION

The Virginia Register of Regulations

Publication: 15:1 VA.R. 4347-4432 September 28, 1998.

The page numbers in volume 15, issue 1 of *The Virginia Register of Regulations* should appear as 1 through 86 instead of 4347 through 4432.

STATE WATER CONTROL BOARD

Title of Regulation: 9 VAC 25-193-10 et seq. General Virginia Pollutant Discharge Elimination System (VPDES) Permit for Ready-Mixed Concrete Plants.

Publication: 14:24 VA.R. 3921-3942 August 17, 1998.

Corrections to Final Regulation:

Page 3926, column 1, 9 VAC 25-193-70 A 1 (5), lines 2, 3, 7 and 8, and column 2, 9 VAC 25-193-70 A 2 (3), lines 2, 3, 7 and 8, change "piedmount" to "piedmont"

Page 3928, column 1, 9 VAC 25-193-70 PART I B 9, line 8, between "and phone number;" and "and the location of the discharge." add "nature of the discharge; number of the outfalls;"

Page 3928, column 2, 9 VAC 25-193-70 PART I B 12 a (4) and b (4), add "in accordance with 9 VAC 25-31-220 F" to the end of both subdivisions

CALENDAR OF EVENTS

Symbol Key

† Indicates entries since last publication of the *Virginia Register*

 Location accessible to handicapped

 Teletype (TTY)/Voice Designation

NOTICE

Only those meetings which are filed with the Registrar of Regulations by the filing deadline noted at the beginning of this publication are listed. Since some meetings are called on short notice, please be aware that this listing of meetings may be incomplete. Also, all meetings are subject to cancellation and the *Virginia Register* deadline may preclude a notice of such cancellation.

For additional information on open meetings and public hearings held by the standing committees of the legislature during the interim, please call Legislative Information at (804) 698-1500 or Senate Information and Constituent Services at (804) 698-7410 or (804) 698-7419/TTY , or visit the General Assembly web site's Legislative Information System (<http://leg1.state.va.us/lis.htm>) and select "Meetings."

VIRGINIA CODE COMMISSION

EXECUTIVE

News, VA 23608, telephone (757) 874-3474 or FAX (757) 886-0671.

BOARD FOR ACCOUNTANCY

October 19, 1998 - 10 a.m. -- Open Meeting
Department of Professional and Occupational Regulation,
3600 West Broad Street, Conference Room 5W, Richmond,
Virginia. 

A meeting to conduct routine business. A public comment period will be held at the beginning of the meeting.

Contact: David E. Dick, Assistant Director, Department of Professional and Occupational Regulation, 3600 W. Broad St., Richmond, VA 23230-4917, telephone (804) 367-8505, FAX (804) 367-2475 or (804) 367-9753/TTY 

DEPARTMENT OF AGRICULTURE AND CONSUMER SERVICES

Virginia Marine Products Board

October 14, 1998 - 6 p.m. -- Open Meeting
Bill's Seafood House, Route 17 and Denbigh Boulevard,
Crafton, Virginia. 

A meeting to receive reports from the Executive Director of the Virginia Marine Products Board on finance, marketing, past and future program planning, publicity/public relations, and old/new business. The board will entertain public comment at the conclusion of all other business for a period not to exceed 30 minutes. Any person who needs any accommodation in order to participate at the meeting should contact Shirley Estes at least five days before the meeting date so that suitable arrangements can be made.

Contact: Shirley Estes, Executive Director, Virginia Marine Products Board, 554 Denbigh Boulevard, Suite B, Newport

Pesticide Control Board

October 15, 1998 - 9 a.m. -- Public Hearing
Department of Agriculture and Consumer Services, 1100
Bank Street, Room 204, Richmond, Virginia.

November 2, 1998 - Public comments may be submitted until this date.

Notice is hereby given in accordance with § 9-6.14:7.1 of the Code of Virginia that the Pesticide Control Board intends to **repeal** regulations entitled: **2 VAC 20-50-10 et seq. Regulations Governing Pesticide Applicator Certification Under Authority of Virginia Pesticide Control Act**, and to **adopt** regulations entitled: **2 VAC 20-51-10 et seq. Regulations Governing Pesticide Applicator Certification Under Authority of Virginia Pesticide Control Act**. The present proposed regulation is predicated on a Notice of Intended Regulatory Action published in the *Virginia Register of Regulations* on May 12, 1997, at page 1910. Although that Notice of Intended Regulatory Action indicated that the agency intended to amend 2 VAC 20-50-10 et seq., Regulations Governing Pesticide Applicator Certification Under Authority of Virginia Pesticide Control Act, the agency has determined, in consultation with the Registrar of Regulations, that it would be simpler to set out the amended language by repealing the entirety of the existing regulation and proposing a new regulation that contains much of the language of the existing regulation, along with the substantive amendments contemplated by the aforementioned Notice of Intended Regulatory Action. The substantive features of the proposed regulation not contained in the existing regulation will clarify requirements for certification of applicators of pesticides in accordance with statutory changes effective July 1, 1995, in §§ 3.1-249.27, 3.1-249.51, and 3.1-249.53 of the Code of Virginia, as well as respond to comments from the general public and

industry workers in response to the agency's review of regulations under the Governor's Executive Order 15 (94). The certification regulation sets standards of certification for persons specified by statute who use or supervise the use of pesticides in Virginia. Those persons governed by the regulation include, but are not limited to, farmers using restricted use pesticides (any pesticide classified for restricted use by the Administrator of the United States Environmental Protection Agency) on their own land and persons who apply pesticides commercially. The certification regulation does not apply to persons who use general use pesticides (any pesticide classified as general use by the Administrator of the United States Environmental Protection Agency) in and around their homes. The certification regulation will help to assure that those persons subject to the certification regulation are adequately trained and competent to use pesticides.

Several changes from the current regulation were made when the proposed regulation was being drafted. Several sections of the proposed regulation were developed to produce a document that is easier to read and comprehend. A few terms and definitions have been added to the proposed certification regulation where needed for clarification. The proposed certification regulation includes a summary of who must be certified to apply pesticides in Virginia. Lists of the various classifications of pesticide applicators and the procedures for becoming certified are also included.

In the section of the proposed certification regulation concerning exemptions (2 VAC 20-51-60), forestry applicators (commercial pesticide applicators who apply pesticides in forestry environments) using general use herbicides (any herbicide classified as general use by the Administrator of the United States Environmental Protection Agency) for forest vegetation control under the direct onsite supervision of a commercial pesticide applicator (an applicator who uses or supervises the use of any pesticide for any purpose or on any property for compensation) have been added to the list of those persons who are exempt from certification. The categories for private pesticide applicator (an applicator who uses or supervises the use of any pesticide which is classified for restricted use for the purposes of producing any agricultural commodity) certification have been combined to form four categories rather than the current seven. A section has been added to the proposed certification regulation to provide details about the specific requirements for on-the-job training for registered technicians (an individual who renders services similar to those of a certified commercial pesticide applicator, but who has not completed all the training or time in service requirements to be eligible for examination for certification as a commercial pesticide applicator and is limited to application of general use pesticides).

2 VAC 20-50-120 was combined with 2 VAC 20-50-130 to make renewal of certification (training) and certificates (the document) occur at the same time

instead of two different years. This proposed section also requires payment of the certificate fee on a biennial basis instead of an annual basis.

2 VAC 20-51-190 has been added to the proposed certification regulation to allow individuals who have received reciprocal certification to be recertified in Virginia by maintaining their training in the state where they are certified. Evidence of Financial Responsibility (2 VAC 20-50-220), a section that is included in the current certification regulation, has been deleted from the proposed certification regulation because it is not the Pesticide Control Board's intent to require Commercial Applicators-Not-for-Hire (a commercial pesticide applicator who uses or supervises the use of pesticides as part of his duties only on property owned or leased by him or his employer) to provide evidence of financial responsibility. This is a requirement placed on commercial firms that apply pesticides and is adequately covered by Rules and Regulations Governing Licensing of Pesticide Businesses by the Department of Agricultural and Consumer Services Operating Under Authority of the Virginia Pesticide Control Act (2 VAC 20-40-80). Any person who needs any accommodation in order to participate at the meeting should contact the board at least 10 days before the meeting date so that suitable arrangements can be made.

Statutory Authority: § 3.1-249.30 of the Code of Virginia.

Contact: Dr. Marvin A. Lawson, Program Manager, Office of Pesticide Services, Virginia Department of Agriculture and Consumer Services, 1100 Bank St., P.O. Box 1163, Room 401, Richmond, VA 23218-1163, telephone (804) 371-6558, FAX (804) 371-8598, toll-free (800) 552-9963 or (804) 371-6344/TTY ☎

STATE AIR POLLUTION CONTROL BOARD

October 28, 1998 - 9 a.m. -- Public Hearing
Department of Environmental Quality, 629 East Main Street,
Training Room, Richmond, Virginia.

November 13, 1998 - Public comments may be submitted until this date.

Notice is hereby given in accordance with § 9-6.14:7.1 of the Code of Virginia that the State Air Pollution Control Board intends to amend regulations entitled: **Regulations for the Control and Abatement of Air Pollution (Rev. GG): 9 VAC 5-20-10 et seq. General Provisions and 9 VAC 5-40-10 et seq. Existing Sources.** The regulation amendments concern provisions covering municipal waste combustors (MWCs). The affected facility to which the provisions of the regulation apply is each MWC unit with a combustion capacity greater than 250 tons per day of municipal solid waste (MSW) for which construction was commenced on or before September 20, 1994.

Calendar of Events

Emissions limitations are established for particulate matter, carbon monoxide, cadmium, lead, sulfur dioxide, hydrogen chloride, dioxin/furan, nitrogen oxides (No_x), opacity, and fugitive dust. Compliance provisions cover startup, shutdown, and malfunction; procedures for calculating unit capacity are specified. Nitrogen oxides emissions averaging, which may be used at the sources' discretion, is described in detail.

Compliance schedules are specified. Operating practices are delineated and include the regulation of particulate matter control device inlet temperature. An important component of the regulation is the operator training and certification provisions, which describe procedures and programs for assuring operator qualifications. Test methods and procedures describe which reference methods are to be used for determining compliance with each emission standard. Monitoring systems are specified, including specific performance specifications and averaging methods. Finally, reporting and recordkeeping requirements describe how all of the above information is to be gathered, stored, and reported.

Request for Comments: The purpose of this notice is to provide the public with the opportunity to comment on the proposed regulation and the costs and benefits of the proposal.

Localities Affected: There is no locality which will bear any identified disproportionate material air quality impact due to the proposed regulation which would not be experienced by other localities.

Location of Proposal: The proposal, an analysis conducted by the department (including a statement of purpose, a statement of estimated impact and benefits of the proposed regulation, an explanation of need for the proposed regulation, an estimate of the impact of the proposed regulation upon small businesses, identification of and comparison with federal requirements, and a discussion of alternative approaches), and any other supporting documents may be examined by the public at the department's Office of Air Regulatory Development (Eighth Floor), 629 East Main Street, Richmond, Virginia, and the department's regional offices (listed below) between 8:30 a.m. and 4:30 p.m. of each business day until the close of the public comment period.

Southwest Regional Office
Department of Environmental Quality
355 Deadmore Street
Abingdon, Virginia
Ph: (540) 676-4800

West Central Regional Office
Department of Environmental Quality
3019 Peters Creek Road
Roanoke, Virginia
Ph: (540) 562-6700

Lynchburg Satellite Office
Department of Environmental Quality
7705 Timberlake Road
Lynchburg, Virginia
Ph: (804) 582-5120

Valley Regional Office
Department of Environmental Quality
4411 Early Road
Harrisonburg, Virginia 22801
Ph: (540) 574-7800

Fredericksburg Satellite Office
Department of Environmental Quality
300 Central Road, Suite B
Fredericksburg, Virginia
Ph: (540) 899-4600

Northern Regional Office
Department of Environmental Quality
13901 Crown Court
Woodbridge, Virginia
Ph: (703) 583-3800

Piedmont Regional Office
Department of Environmental Quality
4949-A Cox Road
Glen Allen, Virginia
Ph: (804) 527-5020

Tidewater Regional Office
Department of Environmental Quality
5636 Southern Boulevard
Virginia Beach, Virginia
Ph: (757) 518-2000

Statutory Authority: § 10.1-1308 of the Code of Virginia.

Public comments may be submitted until 4:30 p.m., November 13, 1998, to the Director, Office of Air Regulatory Development, Department of Environmental Quality, P.O. Box 10009, Richmond, Virginia 23240.

Contact: Karen G. Sabastanski, Policy Analyst, Office of Program Development, Department of Environmental Quality, P.O. Box 10009, Richmond, VA 23240, telephone (804) 698-4426, FAX (804) 698-4510, toll-free 1-800-592-5482 or (804) 698-4021/TTY ☎

ALCOHOLIC BEVERAGE CONTROL BOARD

October 19, 1998 - 9:30 a.m. -- Open Meeting
Department of Alcoholic Beverage Control, 2901 Hermitage Road, Richmond, Virginia. ♿

A meeting to receive reports from and discuss activities of staff members, and to discuss other matters not yet determined.

Contact: W. Curtis Coleburn, Secretary to the Board, Department of Alcoholic Beverage Control, 2901 Hermitage Rd., P.O. Box 27491, Richmond, VA 23261, telephone (804) 213-4409 or FAX (804) 213-4442.

VIRGINIA COMMISSION FOR THE ARTS

† **October 29, 1998 - 10 a.m.** -- Open Meeting
Commission for the Arts, 223 Governor Street, First Floor
Conference Room, Richmond, Virginia.  (Interpreter for the
deaf provided upon request)

The Advisory Panel for Artist Roster will review and
make recommendations on applications from artists to
be included in the Artist Roster of the commission's
Artist Residency Program. The commission will make
the final decisions on which artists should be added to
the roster at the board meeting on December 2.

Contact: Sharon Wilson, Arts in Education Coordinator,
Virginia Commission for the Arts, 223 Governor St.,
Richmond, VA 23219, telephone (804) 225-3132, FAX (804)
225-4327 or (804) 225-3132/TTY 

† **November 9, 1998 - 10 a.m.** -- Open Meeting
Commission for the Arts, 223 Governor Street, First Floor
Conference Room, Richmond, Virginia.  (Interpreter for the
deaf provided upon request)

The Advisory Panel for Fiction Fellowships will review
applications from Virginia writers for 1998-99
fellowships in fiction. The panel will make
recommendations on the fellowships to the full
commission. The commission will meet on December 2
to make the final decisions on the applications. To
receive the list of applicants and order of review, contact
the commission office after November 2.

Contact: Mary C. Poole, Program Coordinator, Virginia
Commission for the Arts, 223 Governor St., Richmond, VA
23219, telephone (804) 225-3132, FAX (804) 225-4327 or
(804) 225-3132/TTY 

† **December 2, 1998 - 8:30 a.m.** -- Open Meeting
Sweet Briar College, Route 29, Elston Hall Conference
Center, Amherst, Virginia.

A quarterly meeting to give final approval of artists to be
added to the Arts in Education Artist Roster and 1998-99
fellowships to individual artists in fiction, crafts,
sculpture and photography and discuss projects to
celebrate the new millennium.

Contact: Peggy Baggett, Executive Director, Virginia
Commission for the Arts, 223 Governor St., Richmond, VA
23219, telephone (804) 225-3132, FAX (804) 225-4327 or
(804) 225-3132/TTY 

BOARD FOR ASBESTOS AND LEAD

November 10, 1998 - 10 a.m. -- Open Meeting
Department of Professional and Occupational Regulation,
3600 West Broad Street, Conference Room 5W, Richmond,
Virginia. 

A meeting to conduct routine business. Public comment
will be received at the beginning of the meeting.

Contact: David E. Dick, Assistant Director, Department of
Professional and Occupational Regulation, 3600 W. Broad
St., Richmond, VA 23230-4917, telephone (804) 367-8505,
FAX (804) 367-2475 or (804) 367-9753/TTY 

COMPREHENSIVE SERVICES FOR AT-RISK YOUTH AND THEIR FAMILIES

State Executive Council

October 30, 1998 - 9 a.m. -- Open Meeting

† **November 20, 1998 - 9 a.m.** -- Open Meeting
Theater Row Building, 730 East Broad Street, Lower Level 2,
Training Room, Richmond, Virginia.

A regular meeting to (i) provide for interagency
programmatic and fiscal policies, (ii) oversee the
administration of funds appropriated under the
Comprehensive Services Act and (iii) advise the
Governor.

Contact: Alan G. Saunders, Director, State Executive
Council, Office of Comprehensive Services for At-Risk Youth
and Their Families, 1604 Santa Rosa Road, Suite 137,
Richmond, VA 23229, telephone (804) 662-9815.

BOARD OF AUDIOLOGY AND SPEECH-LANGUAGE PATHOLOGY

October 29, 1998 - 9 a.m. -- Open Meeting

Department of Health Professions, 6606 West Broad Street,
5th Floor, Conference Room 1, Richmond, Virginia. 

A meeting of the Advisory Committee on Support
Personnel to discuss alternatives to the regulation of
support personnel.

Contact: Senita Booker, Administrative Staff Assistant,
Department of Health Professions, 6606 W. Broad St., 4th
Floor, Richmond, VA 23230-1717, telephone (804) 662-
7390, FAX (804) 662-9523 or (804) 662-7197/TTY 

VIRGINIA AVIATION BOARD

† **October 27, 1998 - 3 p.m.** -- Open Meeting

Department of Motor Vehicles, 2300 West Broad Street,
Richmond, Virginia.  (Interpreter for the deaf provided upon
request)

A workshop for the board. No formal action will be
taken.

Contact: Margaret Fuller, Department of Aviation, 5702
Gulfstream Road, Richmond International Airport, VA 23250-
2422, telephone (804) 236-3632 or (804) 236-3624/TTY 

† **October 28, 1998 - 9 a.m.** -- Open Meeting

Department of Motor Vehicles, 2300 West Broad Street,
Richmond, Virginia.  (Interpreter for the deaf provided upon
request)

Calendar of Events

A regular bimonthly meeting of the board. Applications for state funding will be presented to the board and other matters of the Virginia aviation community will be discussed. Individuals with disabilities should contact Margaret Fuller at least 10 days prior to the meeting if assistance is needed.

Contact: Margaret Fuller, Department of Aviation, 5702 Gulfstream Road, Richmond International Airport, VA 23250-2422, telephone (804) 236-3632 or (804) 236-3624/TTY ☎

BOARD FOR BRANCH PILOTS

† **October 28, 1998 - 9:30 a.m.** -- Open Meeting
Virginia Port Authority, 600 World Trade Center, 6th Floor, Norfolk, Virginia. ♿ (Interpreter for the deaf provided upon request)

A meeting to conduct examinations.

Contact: Mark N. Courtney, Assistant Director, Department of Professional and Occupational Regulation, 3600 W. Broad St., Richmond, VA 23230, telephone (804) 367-8514, FAX (804) 367-2475 or (804) 367-9753/TTY ☎

† **October 29, 1998 - 9:30 a.m.** -- Open Meeting
Virginia Port Authority, 600 World Trade Center, 6th Floor, Norfolk, Virginia. ♿ (Interpreter for the deaf provided upon request)

A general business meeting.

Contact: Mark N. Courtney, Assistant Director, Department of Professional and Occupational Regulation, 3600 W. Broad St., Richmond, VA 23230, telephone (804) 367-8514, FAX (804) 367-2475 or (804) 367-9753/TTY ☎

* * * * *

October 29, 1998 - 9:30 a.m. -- Public Hearing
Virginia Port Authority, 600 World Trade Center, 6th Floor, Norfolk, Virginia.

October 30, 1998 - Public comments may be submitted until this date.

Notice is hereby given in accordance with § 9-6.14:7.1 of the Code of Virginia that the Board for Branch Pilots intends to amend regulations entitled: **18 VAC 45-20-10 et seq. Board for Branch Pilots Regulations.** The purpose of the proposed amendments is to increase fees to comply with § 54.1-113 of the Code of Virginia.

Statutory Authority: §§ 54.1-902 and 54.1-907 of the Code of Virginia.

Contact: Mark N. Courtney, Assistant Director, Department of Professional and Occupational Regulation, 3600 W. Broad St., Richmond, VA 23230, telephone (804) 367-8514.

CHARITABLE GAMING COMMISSION

† **October 20, 1998 - 9 a.m.** -- Open Meeting
Southwest Law Enforcement Academy, 330 Bonham Road, Bristol, Virginia. ♿

A commission training session.

Contact: Kristi Leslie, Administrative Assistant, Charitable Gaming Commission, James Monroe Building, 101 N. 14th St., 17th Floor, Richmond, VA 23219, telephone (804) 786-3014 or FAX (804) 786-1079.

CHESAPEAKE BAY LOCAL ASSISTANCE BOARD

October 13, 1998 - 10 a.m. -- Open Meeting
Chesapeake Bay Local Assistance Department, 805 East Broad Street, Suite 701, Richmond, Virginia. ♿ (Interpreter for the deaf provided upon request)

The Northern Area Review Committee will review Chesapeake Bay Preservation Area programs for the northern area. Persons interested in observing should call the Chesapeake Bay Local Assistance Department to verify meeting time, location and schedule. No comments from the public will be entertained at the review committee meeting; however, written comments are welcome.

Contact: Carolyn J. Elliott, Executive Secretary, Chesapeake Bay Local Assistance Department, 805 E. Broad St., Suite 701, Richmond, VA 23219, telephone (804) 225-3440, FAX (804) 225-3447 or toll-free (800) 243-7229/TTY ☎

October 13, 1998 - 2 p.m. -- Open Meeting
Chesapeake Bay Local Assistance Department, 805 East Broad Street, Suite 701, Richmond, Virginia. ♿ (Interpreter for the deaf provided upon request)

The Southern Area Review Committee will review Chesapeake Bay Preservation Area programs for the southern area. Persons interested in observing should call the Chesapeake Bay Local Assistance Department to verify meeting time, location and schedule. No comments from the public will be entertained at the review committee meeting; however, written comments are welcome.

Contact: Carolyn J. Elliott, Executive Secretary, Chesapeake Bay Local Assistance Department, 805 E. Broad St., Suite 701, Richmond, VA 23219, telephone (804) 225-3440, FAX (804) 225-3447 or toll-free (800) 243-7229/TTY ☎

STATE BOARD FOR COMMUNITY COLLEGES

† **October 13, 1998 - 4 p.m.** -- Open Meeting
Virginia Community College System, James Monroe Building, 101 North 14th Street, 15th Floor, Godwin-Hamel

Board Room, Richmond, Virginia.  (Interpreter for the deaf provided upon request)

A meeting via conference call to certify candidates for the position of president at Piedmont Virginia Community College.

Contact: Dr. Joy S. Graham, Assistant Chancellor, Public Affairs, Virginia Community College System, James Monroe Bldg., 101 N. 14th St., 15th Floor, Richmond, VA 23219, telephone (804) 225-2126, FAX (804) 371-0085, or (804) 371-8504/TTY 

COMPENSATION BOARD

October 29, 1998 - 11 a.m. -- Open Meeting
† November 25, 1998 - 11 a.m. -- Open Meeting
† December 23, 1998 - 11 a.m. -- Open Meeting
202 North 9th Street, Ninth Street Office Building, 10th Floor, Richmond, VA.  (Interpreter for the deaf provided upon request)

Monthly board meeting.

Contact: Cindy P. Waddell, Administrative Assistant, Compensation Board, 202 N. 9th St., Ninth Street Office Bldg., Richmond, VA 23219, telephone (804) 786-0786, FAX (804) 371-0235 or (804) 786-0786/TTY 

BOARD OF CONSERVATION AND RECREATION

October 19, 1998 - 10 a.m. -- Open Meeting
State Capitol, Capitol Square, House Room 1, Richmond, Virginia. 

A regular business meeting.

Contact: Leon E. App, Conservation and Development Programs Supervisor, Department of Conservation and Recreation, 203 Governor St., Suite 302, Richmond, VA 23219, telephone (804) 786-4570 or FAX (804) 786-6141.

DEPARTMENT OF CONSERVATION AND RECREATION

October 24, 1998 - 1 p.m. -- Open Meeting
James Madison University, Harrisonburg, Virginia.

A regular meeting of the Virginia Cave Board to discuss issues relating to cave and karst conservation. A public comment period has been set aside on the agenda.

Contact: Lawrence R. Smith, Natural Area Protection Manager, Department of Conservation and Recreation, Division of Natural Heritage, 217 Governor St., 3rd Floor, Richmond, VA 23219, telephone (804) 786-7951, FAX (804) 371-2674 or (804) 786-2121/TTY 

† October 27, 1998 - 7 p.m. -- Open Meeting
Great Neck Community Recreation Center, 2521 Shorehaven Drive, Room 3, Virginia Beach, Virginia.  (Interpreter for the deaf provided upon request)

A meeting to present the draft recommendations for the development of the Virginia First Landing/Seashore State Park Master Plan and receive public input regarding those recommendations. Requests for an interpreter for the deaf must be made to Derral Jones by October 15.

Contact: Derral Jones, Environmental Program Manager, Department of Conservation and Recreation, Division of Planning and Recreation Resources, 203 Governor St., Suite 326, Richmond, VA 23219, telephone (804) 786-9042 or (804) 786-2121/TTY 

Board of Conservation and Development of Public Beaches

† October 27, 1998 - 10 a.m. -- Open Meeting
Hampton City Hall, Hampton City Council Chambers, Hampton, Virginia.  (Interpreter for the deaf provided upon request)

A meeting to discuss proposed projects by localities requesting matching grant funds, to review the draft report for the "Value of Beaches" study, to review the board's budget and expenditures for the fiscal year, and to receive public comments about public beaches or the activities of the board. Requests for an interpreter for the deaf must be made to Carlton Hill by October 16.

Contact: Carlton Lee Hill, Staff Advisor, Department of Conservation and Recreation, 203 Governor St., Suite 206, Richmond, VA 23219, telephone (804) 786-3998 or FAX (804) 786-1798.

BOARD FOR CONTRACTORS

† October 14, 1998 - 9 a.m. -- Open Meeting
Department of Professional and Occupational Regulation, 3600 West Broad Street, 4th Floor, Richmond, Virginia.  (Interpreter for the deaf provided upon request)

A regularly schedule meeting to (i) address policy and procedural issues, (ii) review and render case decisions on matured complaints against licensees, and (iii) conduct other matters which may require board action. The meeting is open to the public; however, a portion of the board's business may be discussed in executive session. The department fully complies with the Americans with Disabilities Act. Persons desiring to participate in the meeting and requiring special accommodations or interpreter services should contact Geralde W. Morgan.

Contact: Geralde W. Morgan, Assistant Director, Department of Professional and Occupational Regulation,

Calendar of Events

3600 W. Broad St., Richmond, VA 23230, telephone (804) 367-2785, FAX (804) 367-2474 or (804) 367-9753/TTY ☎

DEPARTMENT FOR THE DEAF AND HARD-OF-HEARING

November 4, 1998 - 9 a.m. -- Open Meeting
Department for the Deaf and Hard-of-Hearing, Koger Center, 1602 Rolling Hills Drive, Suite 203, Richmond, Virginia. ♿

A regular meeting of the advisory board. Public comment will be received with advance notice.

Contact: Beverly Chamberlain, Executive Secretary, Department for the Deaf and Hard-of-Hearing, Ratcliffe Bldg., 1602 Rolling Hills Dr., Suite 203, Richmond, VA 23229, telephone (804) 662-9705/Voice/TTY ☎, FAX 1-800-662-9718 or toll-free 1-800-552-7917/Voice/TTY ☎.

BOARD OF DENTISTRY

October 16, 1998 - 9 a.m. -- Open Meeting
Department of Health Professions, 6606 West Broad Street, 4th Floor, Richmond, Virginia. ♿ (Interpreter for the deaf provided upon request)

The Special Conference Committee will meet to hear disciplinary cases. This is a public meeting; however, no public comment will be taken.

Contact: Marcia J. Miller, Executive Director, Board of Dentistry, 6606 W. Broad St., 4th Floor, Richmond, VA 23230-1717, telephone (804) 662-9906 or (804) 662-7197/TTY ☎

October 30, 1998 - 8 a.m. -- Open Meeting
Department of Health Professions, 6606 West Broad Street, 4th Floor, Richmond, Virginia. ♿ (Interpreter for the deaf provided upon request)

A meeting to adopt final regulations on proposed amendments to regulations pursuant to Executive Order 15 (94) which called for clarification, simplification and, where possible, a reduction in regulatory burden (regulations are amended to allow the dentists to delegate acts which are not specifically reserved for dentists/dental hygienists and which are consistent with the training and experience of the assistant), and proposed amendments to regulations to increase fees for licensees of the Board of Dentistry in order to comply with a statutory mandate for the agency to raise revenues sufficient to meet expenses. Public comment on the proposed regulations closed on October 2, 1998; no comment will be accepted at this meeting.

Contact: Marcia J. Miller, Executive Director, Board of Dentistry, 6606 W. Broad St., 4th Floor, Richmond, VA 23230-1717, telephone (804) 662-9906 or (804) 662-7197/TTY ☎

LOCAL EMERGENCY PLANNING COMMITTEE - CHESTERFIELD COUNTY

† **November 5, 1998 - 5:30 p.m.** -- Open Meeting
† **December 3, 1998 - 5:30 p.m.** -- Open Meeting
6610 Public Safety Way, Chesterfield, Virginia.

A regular meeting.

Contact: Lynda G. Furr, Emergency Services Coordinator, Chesterfield Fire Department, P.O. Box 40, Chesterfield, VA 23832, telephone (804) 748-1236.

VIRGINIA FIRE SERVICES BOARD

October 18, 1998 - 10 a.m. -- Open Meeting
English Inn, 2000 Morton Drive, Charlottesville, Virginia.

The Legislative/Liaison Committee will meet to discuss fire training and policies. The meeting is open to the public for input and comments

Contact: Troy H. Lapetina, Executive Director, Department of Fire Programs, James Monroe Bldg., 101 N. 14th St., 18th Floor, Richmond, VA 23219, telephone (804) 371-0220.

October 18, 1998 - 1 p.m. -- Open Meeting
English Inn, 2000 Morton Drive, Charlottesville, Virginia.

A business meeting to discuss fire training and policies. The meeting is open to the public for comments and input.

Contact: Troy H. Lapetina, Executive Director, Department of Fire Programs, James Monroe Bldg., 101 N. 14th St., 18th Floor, Richmond, VA 23219, telephone (804) 371-0220.

BOARD OF FUNERAL DIRECTORS AND EMBALMERS

October 19, 1998 - 9 a.m. -- Open Meeting
Department of Health Professions, 6606 West Broad Street, 4th Floor, Richmond, Virginia. ♿

A general board meeting. Public comment will be received during the first 15 minutes of the meeting. Formal hearings will follow at 1 p.m.

Contact: Cheri Emma-Leigh, Administrative Staff Assistant, Board of Funeral Directors and Embalmers, 6606 W. Broad St., 4th Floor, Richmond, VA 23230-1717, telephone (804) 662-9907, FAX (804) 662-9523 or (804) 662-7197/TTY ☎

† **November 4, 1998 - 9 a.m.** -- Open Meeting
Department of Health Professions, 6606 West Broad Street, 4th Floor, Richmond, Virginia. ♿

A meeting of the Task Force Committee on the Resident Trainee Program to discuss issues related to the program. Public comment will be received during the first 15 minutes of the meeting.

Contact: Cheri Emma-Leigh, Administrative Staff Assistant, Board of Funeral Directors and Embalmers, 6606 W. Broad

St., 4th Floor, Richmond, VA 23230-1717, telephone (804) 662-9907, FAX (804) 662-9523 or (804) 662-7197/TTY ☎

† **November 17, 1998 - 9 a.m.** -- Open Meeting
Department of Health Professions, 6606 West Broad Street, 4th Floor, Richmond, Virginia.♿

The Legislative Committee will meet to continue discussing a legislative proposal for the 2000 Session of the Virginia General Assembly.

Contact: Cheri Emma-Leigh, Administrative Staff Assistant, Board of Funeral Directors and Embalmers, 6606 W. Broad St., 4th Floor, Richmond, VA 23230-1717, telephone (804) 662-9907, FAX (804) 662-9523 or (804) 662-7197/TTY ☎

Special Conference Committee

October 28, 1998 - 9 a.m. -- Open Meeting

October 29, 1998 - 9 a.m. -- Open Meeting

Department of Health Professions, 6606 West Broad Street, 4th Floor, Richmond, Virginia.♿

A meeting to conduct hearings. No public comment will be received.

Contact: Cheri Emma-Leigh, Administrative Staff Assistant, Board of Funeral Directors and Embalmers, 6606 W. Broad St., 4th Floor, Richmond, VA 23230-1717, telephone (804) 662-9970, FAX (804) 662-9523 or (804) 662-7197/TTY ☎

DEPARTMENT OF GAME AND INLAND FISHERIES

October 22, 1998 - 9 a.m. -- Open Meeting

October 23, 1998 - 9 a.m. -- Open Meeting

Department of Game and Inland Fisheries, 4000 West Broad Street, Richmond, Virginia.♿ (Interpreter for the deaf provided upon request)

The board will address amendments to fish and fishing regulations proposed at its August 20, 1998, meeting. This is the regular biennial review of regulations governing freshwater fish and fishing, including seasons, creel limits, methods of take, and possession. The board will solicit comments from the public during the public hearing portion of the meeting, at which time any interested citizen present shall be heard. The board then intends to adopt fishing regulations to be effective from January 1999 through December 2000. The board reserves the right to adopt final amendments which may be more liberal than, or more stringent than the regulations currently in effect, or the regulation amendments proposed at the August 20, 1998, board meeting, as necessary for the proper management of wildlife resources.

The board may review proposals for legislation for the 1999 session of the General Assembly, and may discuss general and administrative issues. The board may hold an executive session before the public session begins on October 22. If the board completes its entire

agenda on October 22, it may not convene on October 23.

Contact: Phil Smith, Policy Analyst, Department of Game and Inland Fisheries, 4010 W. Broad St., Richmond, VA 23230, telephone (804) 367-8341 or FAX (804) 367-2311.

TASK FORCE ON GANGS AND YOUTH VIOLENCE

† **October 14, 1998 - 1:30 p.m.** -- Open Meeting
Office of the Attorney General, 900 East Main Street, 6th Floor, Richmond, Virginia.♿ (Interpreter for the deaf provided upon request)

A meeting of Team 5 of the task force to discuss initiatives providing opportunities for youths.

Contact: Lisa McKeel, Assistant Attorney General, 900 E. Main St., 5th Floor, Richmond, VA 23219, telephone (804) 786-5390 or FAX (804) 786-1991.

† **October 26, 1998 - 1 p.m.** -- Open Meeting
Richmond, Virginia, specific location to be announced.

A meeting of the task force. Specific location in Richmond to be announced.

Contact: Courtney Malveaux, Special Assistant to the Chief, Office of the Attorney General, 900 E. Main St., 6th Floor, Richmond, VA 23219, telephone (804) 692-0552 or FAX (804) 786-1991.

† **October 26, 1998 - 5 p.m.** -- Open Meeting
Richmond, Virginia, specific location to be announced.

Attorney General's summit for the general public on Gangs and Youth Violence.

Contact: Courtney Malveaux, Special Assistant to the Chief, Office of the Attorney General, 900 E. Main St., 6th Floor, Richmond, VA 23219, telephone (804) 692-0552 or FAX (804) 786-1991.

BOARD FOR GEOLOGY

† **October 21, 1998 - 9 a.m.** -- Open Meeting
Department of Professional and Occupational Regulation, 3600 West Broad Street, Richmond, Virginia.♿

A general business meeting. Persons desiring to participate in the meeting and requiring special accommodations or interpreter services should contact the department at least two weeks in advance of the meeting. The department fully complies with the Americans with Disabilities Act.

Contact: William H. Ferguson, II, Board Administrator, Department of Professional and Occupational Regulation, 3600 W. Broad St., Richmond, VA 23230, telephone (804) 367-2406, FAX (804) 367-2475, or (804) 367-9753/TTY ☎

Calendar of Events

GEORGE MASON UNIVERSITY

October 21, 1998 - TBA -- Open Meeting
George Mason University, Mason Hall, Board Room D23,
Fairfax, Virginia. 

A regular meeting of the Board of Visitors to hear reports of the standing committees of the board and to act on those recommendations presented by the standing committees. An agenda will be ready seven days prior to the board meeting for those individuals or organizations who request it.

Contact: Patricia E. Roney, Program Support Tech. Sr., George Mason University, President's Office, Fairfax, VA 22030, telephone (703) 993-8700.

DEPARTMENT OF HEALTH PROFESSIONS

† **November 13, 1998 - 9 a.m.** -- Open Meeting
Department of Health Professions, 6606 West Broad Street,
5th Floor, Conference Room 1, Richmond, Virginia. 
(Interpreter for the deaf provided upon request)

A meeting of the Health Practitioners' Intervention Program Committee to meet with the committee's contractor and representatives to review reports, policies and procedures for the Health Practitioner's Intervention Program. The committee will meet in open session for general discussion of the program. The committee may meet in executive session to consider specific requests from applicants or participants in the program.

Contact: John W. Hasty, Director, Department of Health Professions, 6606 W. Broad St., 4th Floor, Richmond, VA 23230-1717, telephone (804) 662-9424, FAX (804) 662-9114 or (804) 662-7197/TTY 

STATE COUNCIL OF HIGHER EDUCATION FOR VIRGINIA

October 20, 1998 - 8:30 a.m. -- Open Meeting
James Monroe Building, 101 North 14th Street, Richmond,
Virginia. 

November 17, 1998 - 8:30 a.m. -- Open Meeting
James Madison University, Harrisonburg, Virginia. 

A monthly meeting of the committee and council.

Contact: Pamela H. Landrum, Administrative Staff Assistant, State Council of Higher Education, James Monroe Bldg., 101 N. 14th St., 9th Floor, Richmond, VA 23219, telephone (804) 225-2602 or FAX (804) 371-7911.

VIRGINIA HIGHER EDUCATION TUITION TRUST FUND

† **October 29, 1998 - 10 a.m.** -- Open Meeting
James Monroe Building, 101 North 14th Street, 3rd Floor,
Richmond, Virginia. 

A regular meeting of the board of directors.

Contact: Libby Dutton, Director of Administration, Virginia Higher Education Tuition Trust Fund, James Monroe Building, 101 N. 14th St., 5th Floor, Richmond, VA 23219, telephone (804) 786-0719, FAX (804) 786-2453, toll-free 1-888-567-0540 or 1-888-203-1278/TTY 

HOPEWELL INDUSTRIAL SAFETY COUNCIL

November 3, 1998 - 9 a.m. -- Open Meeting
Hopewell Community Center, Second and City Point Road,
Hopewell, Virginia. 
(Interpreter for the deaf provided upon request)

Local Emergency Preparedness Committee meeting on emergency preparedness as required by SARA Title III.

Contact: Robert Brown, Emergency Services Coordinator, 300 N. Main St., Hopewell, VA 23860, telephone (804) 541-2298.

DEPARTMENT OF HOUSING AND COMMUNITY DEVELOPMENT

State Building Code Technical Review Board

† **October 16, 1998 - 10 a.m.** -- Open Meeting
The Jackson Center, 501 North 2nd Street, 1st Floor
Conference Room, Richmond, Virginia. 
(Interpreter for the deaf provided upon request)

A meeting of the board to hear administrative appeals concerning building and fire codes and other regulations of the department. The board issues interpretations and formalizes recommendations to the Board of Housing and Community Development concerning future changes to the regulations.

Contact: Vernon W. Hodge, Building Code Supervisor, State Building Code Office, Department of Housing and Community Development, 501 N. 2nd St., Richmond, VA 23219-1321, telephone (804) 371-7170 or (804) 371-7089/TTY 

VIRGINIA HOUSING DEVELOPMENT AUTHORITY

† **October 20, 1998 - 11 a.m.** -- Open Meeting
Virginia Housing Development Authority, 601 South
Belvidere Street, Richmond, Virginia. 

A regular meeting of the Board of Commissioners to (i) review and, if appropriate, approve the minutes from the prior monthly meeting; (ii) consider and, if appropriate, adopt proposed amendments to the authority's Rules and Regulations for Single Family Mortgage Loans to Persons and Families of Low and Moderate Income; (iii) consider for approval and ratification mortgage loan commitments under the authority's various programs; (iv) review the authority's operations for the prior month; and (v) consider such other matters and take such other actions as it may deem appropriate. Various committees of the board may also meet before or after the regular meeting and consider matters within their purview. The planned agenda of the meeting will be available at the offices of the authority one week prior to the date of the meeting.

Contact: J. Judson McKellar, Jr., General Counsel, Virginia Housing Development Authority, 601 S. Belvidere Street, Richmond, VA 23220, telephone (804) 343-5540, FAX (804) 783-6701, toll-free 1-800-968-7837, or (804) 783-6705/TTY ☎

COUNCIL ON INFORMATION MANAGEMENT

October 15, 1998 - 1:30 p.m. -- Open Meeting
Virginia Military Institute, Lexington, Virginia.

A regular meeting of the Virginia Geographic Information Network Advisory Board.

Contact: Bill Shinar, Virginia Geographic Information Network Coordinator, Council on Information Management, Washington Bldg., 1100 Bank St., Suite 901, Richmond, VA 23219, telephone (804) 225-3622, FAX (804) 371-7952 or toll-free 1-800-828-1120.

October 26, 1998 - 10 a.m. -- Open Meeting
Location to be determined.

A regular meeting of the Land Records Management Task Force.

Contact: Diane Wresinski, Policy and Planning Specialist, Council on Information Management, Washington Bldg., 1100 Bank St., Suite 901, Richmond, VA 23219, telephone (804) 225-3622, FAX (804) 371-7952 or toll-free 1-800-828-1120.

GOVERNOR'S JOB TRAINING COORDINATING COUNCIL

† **October 22, 1998 - 10:30 a.m.** -- Open Meeting
Department for the Aging, Preston Building, 1600 Forest Avenue, Suite 102, Richmond, Virginia. ♿ (Interpreter for the deaf provided upon request)

A regular quarterly business meeting. Topics related to workforce development will be discussed.

Contact: Gail P. Robinson, Policy Analyst, Governor's Employment and Training Department, 730 E. Broad St., 9th

Floor, Richmond, VA 23219, telephone (804) 786-2511, FAX (804) 786-2310 or (804) 786-2315/TTY ☎

STATE BOARD OF JUVENILE JUSTICE

October 14, 1998 - 9 a.m. -- Open Meeting
700 Centre, 700 East Franklin Street, Richmond, Virginia. ♿

The Secure Program Committee and the Nonsecure Program Committee will meet at 9 a.m. The full board will meet at 10 a.m. to take certification action and to take up other matters brought before it.

Contact: Donald R. Carignan, Policy Analyst, Department of Juvenile Justice, 700 E. Franklin St., P.O. Box 1110, Richmond, VA 23218-1110, telephone (804) 371-0743.

DEPARTMENT OF LABOR AND INDUSTRY

October 20, 1998 - 2 p.m. -- Public Hearing
State Capitol, Capitol Square, House Room 2, Richmond, Virginia.

November 30, 1998 - Public comments may be submitted until this date.

Notice is hereby given in accordance with § 9-6.14:7.1 of the Code of Virginia that the Department of Labor and Industry intends to **repeal** regulations entitled: **16 VAC 15-20-10 et seq. Regulations Establishing a Multiple of Federal Minimum Hourly Wage Relating to Garnishment of Wages** and **adopt** regulations entitled: **16 VAC 15-21-10 et seq. Maximum Garnishment Amounts**. Section 34-29 of the Code of Virginia provides that the maximum amount which may be garnished by an employer is that amount by which an employee's disposable earnings for a week exceed 30 times the federal minimum hourly wage rate (F.M.W.R.) in effect at the time earnings are payable. That section also provides that an employer may not garnish more than 25% of disposable earnings in cases of ordinary debt. The section requires the Commissioner of Labor and Industry to establish equivalent maximum earnings which may be garnished by employers for other pay periods, such as biweekly, semimonthly, monthly, and longer than monthly pay periods.

The current regulation, 16 VAC 15-20-10 et seq., contains specific dollar figures based on the then-current F.M.W.R. Since 1970, the F.M.W.R. has increased several times, requiring the commissioner to repeatedly revise the regulation.

The commissioner proposed to repeal the current regulation and to replace it with a new regulation, proposed 16 VAC 15-21-10 et seq. Maximum Garnishment Amounts. The purpose of the replacement regulation is to clearly set forth the method for calculating the necessary amounts, but to omit specific dollar amounts. This new regulation will not make any substantive change to the previous method of

Calendar of Events

calculating the maximum garnishment amounts. The new regulation will simply and clearly state the method of calculation, and omit any specific dollar amounts as shown in the current regulation.

Statutory Authority: § 34-29 of the Code of Virginia.

Public comments may be submitted until November 30, 1998, to Bonnie Hopkins, Regulatory Coordinator, Department of Labor and Industry, 13 South 13th Street, Richmond, VA 23219.

Contact: Anupama Agarwal, Agency Management Analyst Senior, Department of Labor and Industry, Powers-Taylor Bldg., 13 S. 13th St., Richmond, VA 23219, telephone (804) 371-2316, FAX (804) 371-2324 or (804) 786-2376/TTY ☎

Safety and Health Codes Board

October 19, 1998 - 10 a.m. -- Open Meeting
General Assembly Building, 9th and Broad Streets, House Room C, Richmond, Virginia. ♿ (Interpreter for the deaf provided upon request)

A meeting of the Safety and Health Codes Board to discuss:

1. 16 VAC 25-50-10- et seq., Amendments to Boiler and Pressure Vessel Rules and Regulations: Final Rule
2. 16 VAC 25-100-1915.1001, Amendments to Occupational Exposure to Asbestos for Shipyard Employment, (1915.1001): Final Rule
- 16 VAC 25-175-1926.1101, Amendments to Occupational Exposure to Asbestos for Construction (1926.1101): Final Rule
3. Standards Improvement (miscellaneous changes) for General Industry (Part 1910) and Construction Standards (Part 1926): Final Rule

Contact: Regina P. Cobb, Agency Management Analyst Senior, Department of Labor and Industry, Powers-Taylor Bldg., 13 S. 13th St., Richmond, VA 23219, telephone (804) 786-0610, FAX (804) 786-8418 or (804) 786-2376.

LITTER CONTROL AND RECYCLING FUND ADVISORY BOARD

† October 29, 1998 - 10 a.m. -- Open Meeting
701 East Franklin Street, Lower Level Conference Room, Richmond, Virginia. ♿ (Interpreter for the deaf provided upon request)

A work session to review and make recommendations on pending competitive applications for litter prevention and recycling educational programs.

Contact: Michael P. Murphy, Director, Environmental Enhancement, Department of Environmental Quality, 629 E. Main St., Richmond, VA 23219, telephone (804) 698-4003, FAX (804) 698-4319, (804) 698-4021/TTY ☎ or e-mail mpmurphy@deq.state.va.us.

COMMISSION ON LOCAL GOVERNMENT

† October 27, 1998 - 10:30 a.m. -- Open Meeting
Southampton County Office Center, Board of Supervisors Room, 26022 Administrative Center Drive, Courtland, Virginia. ♿ (Interpreter for the deaf provided upon request)

Oral presentations regarding the City of Franklin-Southampton County proposed revenue-sharing agreement.

Contact: Barbara Bingham, Administrative Assistant, Commission on Local Government, Eighth Street Office Bldg., 805 E. Broad St., Room 702, Richmond, VA 23219-1924, telephone (804) 786-6508, FAX (804) 371-7999 or (804) 786-1860/TTY ☎

† October 27, 1998 - 7 p.m. -- Public Hearing
Southampton County Office Center, Board of Supervisors Room, 26022 Administrative Center Drive, Courtland, Virginia. ♿ (Interpreter for the deaf provided upon request)

A public hearing regarding the City of Franklin-Southampton County proposed revenue-sharing agreement.

Contact: Barbara Bingham, Administrative Assistant, Commission on Local Government, Eighth Street Office Bldg., 805 E. Broad St., Room 702, Richmond, VA 23219-1924, telephone (804) 786-6508, FAX (804) 371-7999 or (804) 786-1860/TTY ☎

† November 16, 1998 - 10 a.m. -- Open Meeting
Eighth Street Office Building, 805 East Broad Street, Room 702, Richmond, Virginia. ♿ (Interpreter for the deaf provided upon request)

A regular meeting to consider such matters as may be presented. Persons desiring to participate in the meeting and requiring special accommodations or interpreter services should contact the commission.

Contact: Barbara Bingham, Administrative Assistant, Commission on Local Government, Eighth Street Office Bldg., 805 E. Broad St., Room 702, Richmond, VA 23219-1924, telephone (804) 786-6508, FAX (804) 371-7999 or (804) 786-1860/TTY ☎

VIRGINIA MANUFACTURED HOUSING BOARD

October 20, 1998 - 10 a.m. -- Open Meeting
Department of Housing and Community Development, 501 North 2nd Street, The Jackson Center, 2nd Floor, Richmond, Virginia. ♿ (Interpreter for the deaf provided upon request)

A regular monthly meeting.

Contact: Curtis L. McIver, Associate Director, Department of Housing and Community Development, Manufactured Housing Office, The Jackson Center, 501 N. 2nd St., Richmond, VA 23219, telephone (804) 371-7160 or (804) 371-7089/TTY ☎

MARINE RESOURCES COMMISSION

† **October 27, 1998 - 9:30 a.m.** -- Open Meeting
† **November 23, 1998 - 9:30 a.m.** -- Open Meeting
† **December 21, 1998 - 9:30 a.m.** -- Open Meeting
Marine Resources Commission, 2600 Washington Avenue, Room 403, Newport News, Virginia.  (Interpreter for the deaf provided upon request)

The commission will hear and decide the following marine environmental matters at 9:30 a.m.: permit applications for projects in wetlands, bottom lands, coastal primary sand dunes and beaches; appeals of local wetland board decisions; and policy and regulatory issues. The commission will hear and decide the following fishery management items at approximately noon: regulatory proposals and fishery management plans; fishery conservation issues; licensing; and shellfish leasing. Meetings are open to the public. Testimony will be taken under oath from parties addressing agenda items on permits and licensing. Public comments will be taken on resource matters, regulatory issues and items scheduled for public hearing.

Contact: LaVerne Lewis, Secretary to the Commission, Marine Resources Commission, P.O. Box 756, Newport News, VA 23607-0756, telephone (757) 247-2261, toll-free 1-800-541-4646 or (757) 247-2292/TTY 

MATERNAL AND CHILD HEALTH COUNCIL

† **October 28, 1998 - 1 p.m.** -- Open Meeting
General Assembly, 9th and Broad Streets, 5th Floor, Speaker's Conference Room, Richmond, Virginia.  (Interpreter for the deaf provided upon request)

A meeting to focus on improving the health of the Commonwealth's mothers and children by promoting and improving programs and service delivery systems related to maternal and child health, including prenatal care, school health, and teenage pregnancy.

Contact: Janice M. Hicks, Ph.D., Policy Analyst, Department of Health, Office of Family Health Services, 1500 E. Main St., Room 104, Richmond, VA 23219, telephone (804) 371-0478 or FAX (804) 692-0184.

BOARD OF MEDICAL ASSISTANCE SERVICES

October 13, 1998 - 10 a.m. -- Open Meeting
Department of Medical Assistance Services, 600 East Broad Street, Suite 1300, Richmond, Virginia.

A meeting to discuss medical assistance services policy and to take action on issues pertinent to the board.

Contact: Amy M. Atkinson, Board Liaison, Department of Medical Assistance Services, 600 E. Broad St., Suite 1300, Richmond, VA 23219, telephone (804) 786-8854 or FAX (804) 371-4981.

BOARD OF MEDICINE

Informal Conference Committee

† **October 21, 1998 - 9:30 a.m.** -- Open Meeting
Sheraton Inn, 2801 Plank Road, Fredericksburg, Virginia.

† **November 5, 1998 - 10 a.m.** -- Open Meeting
Roanoke Airport Marriott, 2801 Hershberger Road, Roanoke, Virginia.

A meeting to inquire into allegations that certain practitioners may have violated laws and regulations governing the practice of medicine and other healing arts in Virginia. The committee will meet in open and closed sessions pursuant to § 2.1-344 A 7 and A 15 of the Code of Virginia. Public comment will not be received.

Contact: Karen W. Perrine, Deputy Executive Director, Board of Medicine, 6606 W. Broad St., 4th Floor, Richmond, VA 23230-1717, telephone (804) 662-7693, FAX (804) 662-9517 or (804) 662-7197/TTY 

Advisory Board on Physical Therapy

† **November 18, 1998 - 9 a.m.** -- Public Hearing
Department of Health Professions, 6606 West Broad Street, 5th Floor, Room 1, Richmond, Virginia.  (Interpreter for the deaf provided upon request)

A public hearing regarding amendments to physical therapy regulations to include discussions on inactive license status, requirements for foreign-trained graduates, and biennial review of existing regulations. Following the public hearing, there will be a meeting of the advisory board.

Contact: Warren W. Koontz, M.D., Executive Director, Board of Medicine, Department of Health Professions, 6606 W. Broad St., 4th Floor, Richmond, VA 23230-1717, telephone (804) 662-9960, FAX (804) 662-9943 or (804) 662-7197/TTY 

STATE MENTAL HEALTH, MENTAL RETARDATION AND SUBSTANCE ABUSE SERVICES BOARD

October 26, 1998 - Public comments may be submitted until 5 p.m. on this date.

Notice is hereby given in accordance with § 9-6.14:7.1 of the Code of Virginia that the State Board of Mental Health, Mental Retardation and Substance Abuse Services intends to adopt regulations entitled: **12 VAC 35-210-10 et seq. Certification of the Qualifications of Providers of Behavior Consultation Services.** The proposed regulation defines the specific knowledge, skills, and abilities that mental retardation behavior consultants must have at entry level for Medicaid reimbursement for mental retardation waiver services. The regulation further defines who is subject to

Calendar of Events

certification, the application procedure, the conditions under which a certification can be revoked and subsequently reinstated, provider agreement to inspection of records, and notification that all certified behavior consultants are subject to the department's human rights regulations.

Statutory Authority: §§ 37.1-10 and 37.1-182.2 of the Code of Virginia.

Public comments may be submitted until 5 p.m. on Monday, October 26, 1998, to Cathy Rowe, Office of Mental Retardation Services, Department of Mental Health, Mental Retardation and Substance Abuse Services, P.O. Box 1797, Richmond, VA 23218.

Contact: Marion Greenfield, Policy Analyst, Department of Mental Health, Mental Retardation and Substance Abuse Services, P.O. Box 1797, Richmond, VA 23218, telephone (804) 786-6431 or FAX (804) 371-0092.

October 27, 1998 - 2 p.m. -- Public Hearing
George Mason University, 4400 University Drive, Fairfax, Virginia.

October 28, 1998 - 6 p.m. -- Public Hearing
Richard Bland College, Ernst Hall, 11301 Johnson Road, Petersburg, Virginia.

October 29, 1998 - 1 p.m. -- Public Hearing
Augusta County Government Center, 4801 Lee Highway, Verona, Virginia.

October 29, 1998 - 6 p.m. -- Public Hearing
Hampton City Hall, North King and Lincoln Streets, Hampton, Virginia.

October 30, 1998 - 1 p.m. -- Public Hearing
Wytheville Community College, 1000 East Main Street, Wytheville, Virginia.

November 13, 1998 - Public comments may be submitted until this date.

Notice is hereby given in accordance with § 9-6.14:7.1 of the Code of Virginia that the State Mental Health, Mental Retardation and Substance Abuse Services Board intends to repeal regulations entitled: **12 VAC 35-110-10 et seq. Rules and Regulations to Assure the Rights of Residents of Facilities Operated by the Department of Mental Health, Mental Retardation and Substance Abuse Services.** The proposed regulation protects the legal and human rights of all clients who receive treatment in state operated mental health and mental retardation facilities. This regulation is being repealed and will be superseded by a new human rights regulation, which establishes a single standard for community and facility, public and private human rights programs; addresses consumer and family concerns; and reflects current practices and terminology.

Statutory Authority: § 37.1-84.1 of the Code of Virginia.

Public comments may be submitted until 5 p.m., November 13, 1998, to Marlene Butler, State Board Secretary, Department of Mental Health, Mental Retardation and Substance Abuse Services, P.O. Box 1797, Richmond, VA 23218-1797.

Contact: Kli Kinzie, Secretary, Office of Human Rights, Department of Mental Health, Mental Retardation and Substance Abuse Services, P.O. Box 1797, Richmond, VA 23218-1797, telephone (804) 786-3988 or FAX (804) 371-0092.

October 27, 1998 - 2 p.m. -- Public Hearing
George Mason University, 4400 University Drive, Fairfax, Virginia.

October 28, 1998 - 6 p.m. -- Public Hearing
Richard Bland College, Ernst Hall, 11301 Johnson Road, Petersburg, Virginia.

October 29, 1998 - 1 p.m. -- Public Hearing
Augusta County Government Center, 4801 Lee Highway, Verona, Virginia.

October 29, 1998 - 6 p.m. -- Public Hearing
Hampton City Hall, North King and Lincoln Streets, Hampton, Virginia.

October 30, 1998 - 1 p.m. -- Public Hearing
Wytheville Community College, 1000 East Main Street, Wytheville, Virginia.

November 13, 1998 - Public comments may be submitted until this date.

Notice is hereby given in accordance with § 9-6.14:7.1 of the Code of Virginia that the State Mental Health, Mental Retardation and Substance Abuse Services Board intends to adopt regulations entitled: **12 VAC 35-115-10 et seq. Rules and Regulations to Assure the Rights of Clients in Facilities and Programs Operated, Funded or Licensed by the Department of Mental Health, Mental Retardation and Substance Abuse Services.** The proposed regulation protects the legal and human rights of all clients who receive treatment in state operated mental health and mental retardation facilities and other agencies, public or private that receive or benefit from state funding under the provisions of Chapter 10, Title 37.1 of the Code of Virginia, and all other providers that are required to be licensed by the Department of Mental Health, Mental Retardation and Substance Abuse Services.

Statutory Authority: § 37.1-84.1 of the Code of Virginia.

Public comments may be submitted until 5 p.m., November 13, 1998, to Marlene Butler, State Board Secretary, Department of Mental Health, Mental Retardation and Substance Abuse Services, P.O. Box 1797, Richmond, VA 23218-1797.

Contact: Kli Kinzie, Secretary, Office of Human Rights, Department of Mental Health, Mental Retardation and Substance Abuse Services, P.O. Box 1797, Richmond, VA 23218-1797, telephone (804) 786-3988 or FAX (804) 371-0092.

October 27, 1998 - 2 p.m. -- Public Hearing
George Mason University, 4400 University Drive, Fairfax, Virginia.

October 28, 1998 - 6 p.m. -- Public Hearing
Richard Bland College, Ernst Hall, 11301 Johnson Road, Petersburg, Virginia.

October 29, 1998 - 1 p.m. -- Public Hearing
Augusta County Government Center, 4801 Lee Highway, Verona, Virginia.

October 29, 1998 - 6 p.m. -- Public Hearing
Hampton City Hall, North King and Lincoln Streets, Hampton, Virginia.

October 30, 1998 - 1 p.m. -- Public Hearing
Wytheville Community College, 1000 East Main Street, Wytheville, Virginia.

November 13, 1998 - Public comments may be submitted until this date.

Notice is hereby given in accordance with § 9-6.14:7.1 of the Code of Virginia that the State Mental Health, Mental Retardation and Substance Abuse Services Board intends to repeal regulations entitled: **12 VAC 35-120-10 et seq. Rules and Regulations to Assure the Rights of Patients of Psychiatric Hospitals and Other Psychiatric Facilities Licensed by the Department of Mental Health, Mental Retardation and Substance Abuse Services.** The proposed regulation protects the legal and human rights of all clients who receive treatment in psychiatric hospitals and other psychiatric facilities licensed by the Department of Mental Health, Mental Retardation and Substance Abuse Services. This regulation is being repealed and will be superseded by a new human rights regulation, which establishes a single standard for community and facility, public and private human rights programs; addresses consumer and family concerns; and reflects current practices and terminology.

Statutory Authority: § 37.1-84.1 of the Code of Virginia.

Public comments may be submitted until 5 p.m., November 13, 1998, to Marlene Butler, State Board Secretary, Department of Mental Health, Mental Retardation and Substance Abuse Services, P.O. Box 1797, Richmond, VA 23218-1797.

Contact: Kli Kinzie, Secretary, Office of Human Rights, Department of Mental Health, Mental Retardation and Substance Abuse Services, P.O. Box 1797, Richmond, VA

23218-1797, telephone (804) 786-3988 or FAX (804) 371-0092.

October 27, 1998 - 2 p.m. -- Public Hearing
George Mason University, 4400 University Drive, Fairfax, Virginia.

October 28, 1998 - 6 p.m. -- Public Hearing
Richard Bland College, Ernst Hall, 11301 Johnson Road, Petersburg, Virginia.

October 29, 1998 - 1 p.m. -- Public Hearing
Augusta County Government Center, 4801 Lee Highway, Verona, Virginia.

October 29, 1998 - 6 p.m. -- Public Hearing
Hampton City Hall, North King and Lincoln Streets, Hampton, Virginia.

October 30, 1998 - 1 p.m. -- Public Hearing
Wytheville Community College, 1000 East Main Street, Wytheville, Virginia.

November 13, 1998 - Public comments may be submitted until this date.

Notice is hereby given in accordance with § 9-6.14:7.1 of the Code of Virginia that the State Mental Health, Mental Retardation and Substance Abuse Services Board intends to repeal regulations entitled: **12 VAC 35-130-10 et seq. Rules and Regulations to Assure the Rights of Clients in Community Programs.** The proposed regulation protects the legal and human rights of all clients who receive treatment in community programs funding or licensed by the Department of Mental Health, Mental Retardation and Substance Abuse Services. This regulation is being repealed and will be superseded by a new human rights regulation, which establishes a single standard for community and facility, public and private human rights programs; addresses consumer and family concerns; and reflects current practices and terminology.

Statutory Authority: § 37.1-84.1 of the Code of Virginia.

Public comments may be submitted until 5 p.m., November 13, 1998, to Marlene Butler, State Board Secretary, Department of Mental Health, Mental Retardation and Substance Abuse Services, P.O. Box 1797, Richmond, VA 23218-1797.

Contact: Kli Kinzie, Secretary, Office of Human Rights, Department of Mental Health, Mental Retardation and Substance Abuse Services, P.O. Box 1797, Richmond, VA 23218-1797, telephone (804) 786-3988 or FAX (804) 371-0092.

Calendar of Events

DEPARTMENT OF MINES, MINERALS AND ENERGY

October 16, 1998 - Public comments may be submitted until this date.

Notice is hereby given in accordance with § 9-6.14:7.1 of the Code of Virginia that the Department of Mines, Minerals and Energy intends to repeal regulations entitled: **4 VAC 25-50-10 et seq. Rules and Regulations Governing the Certification of Diesel Engine Mechanics in Underground Coal Mines.** The regulation is being repealed because the essential elements in the regulation have been incorporated in the certification regulation for coal miners.

Statutory Authority: § 45.1-161.28 of the Code of Virginia.

Contact: Frank Linkous, Mine Division Chief, Department of Mines, Minerals and Energy, Division of Mines, U. S. Route 23 South, P. O. Drawer 900, Big Stone Gap, VA 24219, telephone (540) 523-8224, FAX (540) 523-8239 or toll-free 1-800-1120 (VA Relay Center)

* * * * *

October 16, 1998 - Public comments may be submitted until this date.

Notice is hereby given in accordance with § 9-6.14:7.1 of the Code of Virginia that the Department of Mines, Minerals and Energy intends to amend regulations entitled: **4 VAC 25-60-10 et seq. Rules and Regulations Governing the Installation and Use of Automated Temporary Roof Support (ATRS) Systems.** The regulation serves to protect miners from unsupported roof falls before permanent roof supports are installed in a newly mined area of an underground coal mine. Amendments to the regulation make the requirements consistent with current safety standards for ATRS systems and consistent with the rules of the Mine Safety and Health Administration.

Statutory Authority: §§ 45.1-161.3, 45.1-161.106, and 45.1-161.114 of the Code of Virginia.

Contact: Frank Linkous, Mine Division Chief, Department of Mines, Minerals and Energy, Division of Mines, U. S. Route 23 South, P. O. Drawer 900, Big Stone Gap, VA 24219, telephone (540) 523-8224, FAX (540) 523-8239 or toll-free 1-800-1120 (VA Relay Center)

* * * * *

October 16, 1998 - Public comments may be submitted until this date.

Notice is hereby given in accordance with § 9-6.14:7.1 of the Code of Virginia that the Department of Mines, Minerals and Energy intends to amend regulations entitled: **4 VAC 25-70-10. Rules and Regulations Governing Disruption of Communications in Mines.**

The regulation ensures that there is a system of communication between those mining coal underground and mine personnel on the surface so miners can get help in case of an emergency. Amendments to the regulation address important hazards not addressed by the Mine Safety and Health Administration (MSHA), avoid conflicts with MSHA regulations and federal law, and eliminate duplicative information.

Statutory Authority: §§ 45.1-161.3, 45.1-161.106 and 45.1-161.191 of the Code of Virginia.

Contact: Frank Linkous, Mine Division Chief, Department of Mines, Minerals and Energy, Division of Mines, U. S. Route 23 South, P. O. Drawer 900, Big Stone Gap, VA 24219, telephone (540) 523-8224, FAX (540) 523-8239 or toll-free 1-800-1120 (VA Relay Center)

* * * * *

October 16, 1998 - Public comments may be submitted until this date.

Notice is hereby given in accordance with § 9-6.14:7.1 of the Code of Virginia that the Department of Mines, Minerals and Energy intends to repeal regulations entitled: **4 VAC 25-80-10. Rules and Regulations Governing Advanced First Aid.** The regulation sets forth requirements for first aid training and the number of persons with first aid training needed on the mine site. However, the regulations are no longer needed as stand-alone requirements because they are incorporated in the certification requirements for coal miners promulgated by the Board of Coal Mining Examiners.

Statutory Authority: § 45.1-161.3, 45.1-161.101, 45.1-106 and 45.1-161.254 of the Code of Virginia.

Contact: Frank Linkous, Mine Division Chief, Department of Mines, Minerals and Energy, Division of Mines, U. S. Route 23 South, P. O. Drawer 900, Big Stone Gap, VA 24219, telephone (540) 523-8224, FAX (540) 523-8239 or toll-free 1-800-1120 (VA Relay Center)

* * * * *

October 16, 1998 - Public comments may be submitted until this date.

Notice is hereby given in accordance with § 9-6.14:7.1 of the Code of Virginia that the Department of Mines, Minerals and Energy intends to amend regulations entitled: **4 VAC 25-110-10 et seq. Rules and Regulations Governing Blasting in Surface Mining Operations.** The regulation ensures that blasting performed in conjunction with coal mining is performed safely and efficiently. It serves to protect miners, persons living close to mines, and property from fly rock and other hazards associated with blasting. Amendments to the regulation address important hazards not addressed by the Mine, Safety and Health Administration (MSHA) and avoid conflicts with MSHA

regulations in federal law, address changes in technology and eliminate duplicative information.

Statutory Authority: §§ 45.1-161.3, 46.1-161.254 and 45.1-161.286 of the Code of Virginia.

Contact: Frank Linkous, Mine Division Chief, Department of Mines, Minerals and Energy, Division of Mines, U. S. Route 23 South, P. O. Drawer 900, Big Stone Gap, VA 24219, telephone (540) 523-8224, FAX (540) 523-8239 or toll-free 1-800-1120 (VA Relay Center)

* * * * *

October 16, 1998 - Public comments may be submitted until this date.

Notice is hereby given in accordance with § 9-6.14:7.1 of the Code of Virginia that the Department of Mines, Minerals and Energy intends to amend regulations entitled: **4 VAC 25-120-10 et seq. Rules and Regulations Governing Installation and Use of Cabs and Canopies.** The regulation protects persons operating self-propelled mobile equipment at the face of coal mines from roof falls. Amendments are needed to address important hazards not addressed by the Mine Safety and Health Administration (MSHA), to avoid conflicts with MSHA regulations and federal law, and to adopt standards for loads and capacities.

Statutory Authority: §§ 45.1-161.3 and 45.1-161.106 of the Code of Virginia.

Contact: Frank Linkous, Mine Division Chief, Department of Mines, Minerals and Energy, Division of Mines, U. S. Route 23 South, P. O. Drawer 900, Big Stone Gap, VA 24219, telephone (540) 523-8224, FAX (540) 523-8239 or toll-free 1-800-1120 (VA Relay Center)

DEPARTMENT OF MOTOR VEHICLES

Medical Advisory Board

October 14, 1998 - 1 p.m. -- Open Meeting
Department of Motor Vehicles, 2300 West Broad Street, Richmond, Virginia. 

A regular business meeting.

Contact: Phyllis A. Dardenne, Program Manager, Department of Motor Vehicles, 2300 W. Broad St., Richmond, VA 23220, telephone (804) 367-2581.

VIRGINIA MUSEUM OF FINE ARTS

November 3, 1998 - 8 a.m. -- Open Meeting
Virginia Museum of Fine Arts, 2800 Grove Avenue, Conference Room, Richmond, Virginia. 

The Executive Committee will hold a monthly briefing/work session with the staff. Public comment will not be received at the meeting.

Contact: Emily C. Robertson, Secretary of the Museum, Virginia Museum of Fine Arts, 2800 Grove Ave., Richmond, VA 23221, telephone (804) 367-0553 or FAX (804) 367-2633.

† **November 19, 1998 - 10 a.m.** -- Open Meeting
Virginia Museum of Fine Arts, 2800 Grove Avenue, Auditorium, Richmond, Virginia. 

The Exhibitions Committee will discuss and consider upcoming exhibitions and review current and recent exhibitions. Public comment will not be received at the meeting.

Contact: Emily C. Robertson, Secretary of the Museum, Virginia Museum of Fine Arts, 2800 Grove Ave., Richmond, VA 23221, telephone (804) 367-0553 or FAX (804) 367-2633.

† **November 19, 1998 - 3 p.m.** -- Open Meeting
Virginia Museum of Fine Arts, 2800 Grove Avenue, Conference Room, Richmond, Virginia. 

The initial meeting of the Planning Committee for the 1998-99 season. Public comment will not be received at the meeting.

Contact: Emily C. Robertson, Secretary of the Museum, Virginia Museum of Fine Arts, 2800 Grove Ave., Richmond, VA 23221, telephone (804) 367-0553 or FAX (804) 367-2633.

VIRGINIA MUSEUM OF NATURAL HISTORY

† **November 7, 1998 - 1 p.m.** -- Open Meeting
Dutch Inn, 2360 Virginia Avenue, Collinsville, Virginia. 

A meeting of the Board of Trustees to receive reports from the development, executive, finance, legislative, marketing, nominating, outreach, personnel, planning and facilities, and research and collections committees. Public comment will be received following approval of the minutes of the August meeting.

Contact: Rhonda J. Knighton, Executive Assistant, Virginia Museum of Natural History, 1001 Douglas Ave., Martinsville, VA 24112, telephone (540) 666-8600 or (540) 666-0360, or (540) 666-8638/TTY 

BOARD OF NURSING

October 13, 1998 - 9 a.m. -- Open Meeting
October 15, 1998 - 9 a.m. -- Open Meeting
† **October 20, 1998 - 9 a.m.** -- Open Meeting
† **October 21, 1998 - 9 a.m.** -- Open Meeting
† **October 22, 1998 - 9 a.m.** -- Open Meeting
† **October 29, 1998 - 9 a.m.** -- Open Meeting

Calendar of Events

Department of Health Professions, 6606 West Broad Street, 5th Floor, Richmond, Virginia.  (Interpreter for the deaf provided upon request)

† **October 21, 1998 - 10:30 a.m.** -- Open Meeting
Enterprise Academy, 813 Dilligence Drive, Newport News, Virginia.  (Interpreter for the deaf provided upon request)

A Special Conference Committee will conduct informal conferences with licensees and certificate holders. Public comments will not be received.

Contact: Nancy K. Durrett, R.N., Executive Director, Board of Nursing, 6606 W. Broad St., 4th Floor, Richmond, VA 23230-1717, telephone (804) 662-9909, FAX (804) 662-9943 or (804) 662-7197/TTY 

BOARD OF NURSING HOME ADMINISTRATORS

October 26, 1998 - 1 p.m. -- Open Meeting
Department of Health Professions, 6606 West Broad Street, 5th Floor, Conference Room 3, Richmond, Virginia. 

A Special Conference Committee will hold informal hearings. No public comments will be heard.

Contact: Senita Booker, Administrative Staff Assistant, Board of Nursing Home Administrators, 6606 W. Broad St., 4th Floor, Richmond, VA 23230-1717, telephone (804) 662-9111, FAX (804) 662-9523 or (804) 662-7197/TTY 

October 27, 1998 - 9 a.m. -- Open Meeting
Department of Health Professions, 6606 West Broad Street, 5th Floor, Conference Room 3, Richmond, Virginia. 

A forum on the need for regulation/licensure of assisted care resident managers. Public comments will be received prior to the beginning of the meeting.

Contact: Senita Booker, Administrative Staff Assistant, Board of Nursing Home Administrators, 6606 W. Broad St., 4th Floor, Richmond, VA 23230-1717, telephone (804) 662-9111, FAX (804) 662-9523 or (804) 662-7197/TTY 

BOARD FOR OPTICIANS

† **November 13, 1998 - 9 a.m.** -- Open Meeting
Department of Professional and Occupational Regulation, 3600 West Broad Street, Richmond, Virginia.  (Interpreter for the deaf provided upon request)

A meeting to discuss regulatory review, disciplinary cases and other matters requiring board action.

Contact: Nancy Taylor Feldman, Assistant Director, Department of Professional and Occupational Regulation, 3600 W. Broad St., Richmond, VA 23230, telephone (804) 367-8590, FAX (804) 367-2474 or (804) 367-9753/TTY 

BOARD OF OPTOMETRY

November 6, 1998 - 9 a.m. -- Public Hearing
Department of Health Professions, 6606 West Broad Street, 5th Floor, Conference Room 3, Richmond, Virginia.

Notice is hereby given in accordance with § 9-6.14:7.1 of the Code of Virginia that the Board of Optometry intends to amend regulations entitled: **18 VAC 105-30-10 et seq. Regulations Governing the Certification of Optometrists to Use Therapeutic Pharmaceutical Agents.** The amendments are proposed to specify the training and examination required, to establish a protocol for treatment of acute angle closure glaucoma, to review the renewal schedule from biennial to annual with a fee of \$75 (currently \$125 biennially), and to lower the application fee from \$300 to \$200.

Statutory Authority: §§ 54.1-2400 and 54.1-3223 of the Code of Virginia.

Contact: Elizabeth A. Carter, Ph.D., Executive Director, Board of Optometry, 6606 W. Broad St., 4th Floor, Richmond, VA 23230-1717, telephone (804) 662-9910 or FAX (804) 662-9943.

VIRGINIA OUTDOORS FOUNDATION

† **October 13, 1998 - 3 p.m.** -- Open Meeting
Augusta County Government Center, South Board Room, Verona, Virginia.  (Interpreter for the deaf provided upon request)

A meeting of the Trust Fund Advisory Board (Region 1) to conduct the general business of the board, review applications received for funding under the Open Space Lands Preservation Trust Fund, and make recommendations on funding. Public comment will be received after the conclusion of the regular business meeting.

Contact: Sherry Buttrick, Director, Virginia Outdoors Foundation, 1010 Harris St., #101, Charlottesville, VA 22903, telephone (804) 293-3423.

† **October 13, 1998 - 3 p.m.** -- Open Meeting
Wytheville Community College, Smyth Hall, Continuing Education Conference Room, Wytheville, Virginia.  (Interpreter for the deaf provided upon request)

A meeting of the Open Space Lands Preservation Fund Advisory Board (Region 4) to conduct the business of the board, review applications received for funding under the Open Space Lands Preservation Trust Fund, and make recommendations on funding. Public comment will be received after the conclusion of the regular business meeting.

Contact: Tamara Vance, Executive Director, Virginia Outdoors Foundation, 203 Governor St., Room 317, Richmond, VA 23219, telephone (804) 225-2147 or FAX (804) 371-4810.

† **October 14, 1998 - 10 a.m.** -- Open Meeting
† **December 10, 1998 - 10 a.m.** -- Open Meeting
State Capitol, Capitol Square, Richmond, Virginia.

A regularly scheduled meeting of the Board of Trustees to discuss foundation business and accept conservation easements. Public input will be accepted after the regular business meeting.

Contact: Tamara Vance, Executive Director, Virginia Outdoors Foundation, 203 Governor St., Room 317, Richmond, VA 23219, telephone (804) 225-2147 or FAX (804) 371-4810.

BOARD OF PHARMACY

October 14, 1998 - 8:30 a.m. -- Public Hearing
Department of Health Professions, 6606 West Broad Street, 5th Floor, Conference Room 2, Richmond, Virginia.📍

A public hearing to solicit information to assist in determining whether regulations should be promulgated to require a pharmacist to obtain from the prescriber additional documented consent beyond the check boxes on the prescription blanks any time there is a substitution or interchange of one manufacturer's product of a narrow therapeutic index (NTI) drug for another manufacturer's generically equivalent product, either on the initial dispensing or on any subsequent refill of a prescription (reference §§ 32.1-87 C and 54.1-3408 C of the Code of Virginia). The board will also hold a general business meeting and may consider disciplinary matters and conduct disciplinary hearings.

Contact: Elizabeth Scott Russell, Executive Director, Board of Pharmacy, 6606 W. Broad St., 4th Floor, Richmond, VA 23230-1717, telephone (804) 662-9911, FAX (804) 662-9313 or (804) 662-7197/TTY 📞

October 20, 1998 - 9 a.m. -- Open Meeting
October 28, 1998 - 9 a.m. -- Open Meeting
Department of Health Professions, 6606 West Broad Street, 5th Floor, Conference Room 1, Richmond, Virginia.📍

A Special Conference Committee will hear informal conferences. Public comments will not be received.

Contact: Elizabeth Scott Russell, Executive Director, Board of Pharmacy, 6606 W. Broad St., 4th Floor, Richmond, VA 23230-1717, telephone (804) 662-9911, FAX (804) 662-9313 or (804) 662-7197/TTY 📞

BOARD FOR PROFESSIONAL AND OCCUPATIONAL REGULATION

November 16, 1998 - 10 a.m. -- Open Meeting
Department of Professional and Occupational Regulation, 3600 West Broad Street, Richmond, Virginia.📍

A general business meeting.

Contact: Debra S. Vought, Agency Analyst, Department of Professional and Occupational Regulation, 3600 W. Broad St., Richmond, VA 23230, telephone (804) 367-8519 or (804) 367-9753/TTY 📞

BOARD OF LICENSED PROFESSIONAL COUNSELORS, MARRIAGE AND FAMILY THERAPISTS AND SUBSTANCE ABUSE TREATMENT PROFESSIONALS

October 27, 1998 - 10 a.m. -- Open Meeting
Department of Health Professions, 6606 West Broad Street, 5th Floor, Conference Room 4, Richmond, Virginia.📍

The Regulatory Committee will consider results of a survey mailed to graduate counseling programs regarding proposed changes to its regulations governing marriage and family therapist and professional counselor licensure and to propose new regulations governing substance abuse treatment practitioner licensure. The committee will also discuss possible amendments to its regulations governing substance abuse counselor certification. Public comment will be received at the beginning of the meeting.

Contact: Janet Delorme, Deputy Executive Director, Board of Licensed Professional Counselors, Marriage and Family Therapists and Substance Abuse Treatment Professionals, 6606 W. Broad St., 4th Floor, Richmond, VA 23230, telephone (804) 662-9575, FAX (804) 662-9943 or (804) 662-7197/TTY 📞

† **November 12, 1998 - 9 a.m.** -- Open Meeting
Department of Health Professions, 6606 West Broad Street, 5th Floor, Conference Room 2, Richmond, Virginia.📍

Meetings of the following committees: credentials, discipline, supervision, regulatory, public relations, executive and legislative. No public comment will be received.

Contact: Evelyn Brown, Executive Director, or Joyce Williams, Administrative Assistant, Board of Licensed Professional Counselors, Marriage and Family Therapists and Substance Abuse Treatment Professionals, 6606 W. Broad St., 4th Floor, Richmond, VA 23230, telephone (804) 662-9912 or FAX (804) 662-9943.

† **November 13, 1998 - 10 a.m.** -- Open Meeting
Department of Health Professions, 6606 West Broad Street, 5th Floor, Conference Room 2, Richmond, Virginia.📍

A regular meeting to conduct general board business, regulatory review, consider committee reports and correspondence and any other matters under the jurisdiction of the board.

Contact: Evelyn Brown, Executive Director, or Joyce Williams, Administrative Assistant, Board of Licensed Professional Counselors, Marriage and Family Therapists and Substance Abuse Treatment Professionals, 6606 W.

Calendar of Events

Broad St., 4th Floor, Richmond, VA 23230, telephone (804) 662-9912 or FAX (804) 662-9943.

VIRGINIA RACING COMMISSION

October 21, 1998 - 9:30 a.m. -- Open Meeting
Administrative Building, 12007 Courthouse Circle, New Kent, Virginia. 

A monthly meeting of the commission including hearing plans for the forthcoming Breeders Crown races. Public comment will be received.

Contact: William H. Anderson, Policy Analyst, Virginia Racing Commission, 10700 Horsemen's Rd., New Kent, VA 23124, telephone (804) 966-4200 or FAX (804) 966-8906.

November 18, 1998 - 9:30 a.m. -- Open Meeting
Administrative Building, 12007 Courthouse Circle, New Kent, Virginia. 

A monthly meeting of the commission including a report by Colonial Downs. Public comment will be received.

Contact: William H. Anderson, Policy Analyst, Virginia Racing Commission, 10700 Horsemen's Rd., New Kent, VA 23124, telephone (804) 966-4200 or FAX (804) 966-8906.

* * * * *

† November 18, 1998 - 9:30 a.m. -- Public Hearing
Virginia Racing Commission, 12007 Courthouse Circle, Administrative Building, New Kent, Virginia.

December 11, 1998 - Public comments may be submitted until this date.

Notice is hereby given in accordance with § 9-6.14:7.1 of the Code of Virginia that the Virginia Racing Commission intends to amend regulations entitled: **11 VAC 10-60-10 et seq. Regulations Pertaining to Horse Racing with Pari-Mutuel Wagering: Participants.** The proposed regulation reflects more closely the intent of the statute regarding the consideration of applications for participation in horse racing, thereby eliminating the provisional permit. Furthermore, the regulation takes into account changes in the standard operating procedures found at most racetracks in the mid-Atlantic region since the current regulation was promulgated seven years ago.

Statutory Authority: § 59.1-369 of the Code of Virginia.

Contact: William H. Anderson, Policy Analyst, Virginia Racing Commission, 10700 Horsemen's Road, New Kent, VA 23124, telephone (804) 966-4200 or FAX (804) 966-8906.

REAL ESTATE APPRAISER BOARD

October 27, 1998 - 10 a.m. -- Open Meeting
Department of Professional and Occupational Regulation, 3600 West Broad Street, Richmond, Virginia. 

A general business meeting. Persons desiring to participate in the meeting and requiring special accommodations or interpreter services should contact the board at least two weeks prior to the meeting. The department fully complies with the Americans with Disabilities Act.

Contact: Karen W. O'Neal, Assistant Director, Department of Professional and Occupational Regulation, 3600 W. Broad St., Richmond, VA 23230, telephone (804) 367-8526, FAX (804) 367-2475, or (804) 367-9753/TTY 

REAL ESTATE BOARD

† October 22, 1998 - 8 a.m. -- Open Meeting
Department of Professional and Occupational Regulation, 3600 West Broad Street, Richmond, Virginia.  (Interpreter for the deaf provided upon request)

A general business meeting of the Education Committee. Persons desiring to participate in the meeting and requiring special accommodations or interpreter services should contact the board at least two weeks prior to the meeting. The department fully complies with the Americans with Disabilities Act.

Contact: Karen W. O'Neal, Assistant Director, Department of Professional and Occupational Regulation, 3600 W. Broad St., Richmond, VA 23230, telephone (804) 367-8526, FAX (804) 367-2475, or (804) 367-9753/TTY 

† October 22, 1998 - 8 a.m. -- Open Meeting
Department of Professional and Occupational Regulation, 3600 West Broad Street, Richmond, Virginia.  (Interpreter for the deaf provided upon request)

A general business meeting of the Fair Housing Committee. Persons desiring to participate in the meeting and requiring special accommodations or interpreter services should contact the board at least two weeks prior to the meeting. The department fully complies with the Americans with Disabilities Act.

Contact: Karen W. O'Neal, Assistant Director, Department of Professional and Occupational Regulation, 3600 W. Broad St., Richmond, VA 23230, telephone (804) 367-8526, FAX (804) 367-2475, or (804) 367-9753/TTY 

† October 22, 1998 - 9 a.m. -- Open Meeting
Department of Professional and Occupational Regulation, 3600 West Broad Street, Richmond, Virginia.  (Interpreter for the deaf provided upon request)

A general business meeting of the full board. Persons desiring to participate in the meeting and requiring special accommodations or interpreter services should contact the board at least two weeks prior to the

meeting. The department fully complies with the Americans with Disabilities Act.

Contact: Karen W. O'Neal, Assistant Director, Department of Professional and Occupational Regulation, 3600 W. Broad St., Richmond, VA 23230, telephone (804) 367-8526, FAX (804) 367-2475, or (804) 367-9753/TTY ☎

Common Interest Community Management Information Fund Advisory Committee

October 22, 1998 - 3 p.m. -- Open Meeting
Department of Professional and Occupational Regulation,
3600 West Broad Street, Richmond, Virginia. 🗺

A general business meeting. Persons desiring to participate in the meeting and requiring special accommodations or interpreter services should contact the board at least two weeks prior to the meeting. The department fully complies with the Americans with Disabilities Act.

Contact: Karen W. O'Neal, Assistant Director, Department of Professional and Occupational Regulation, 3600 W. Broad St., Richmond, VA 23230, telephone (804) 367-8526, FAX (804) 367-2475, or (804) 367-9753/TTY ☎

VIRGINIA RECYCLING MARKETS DEVELOPMENT COUNCIL

† **October 28, 1998 - 9 a.m.** -- Open Meeting
Central Virginia Waste Management Authority, 2104 West
Laburnum Avenue, Board Room, Richmond, Virginia. 🗺
(Interpreter for the deaf provided upon request)

An ad hoc subcommittee meeting to discuss the results of the 1998 Virginia Local Government Recycling Program survey pursuant to House Bill 2881 (97).

Contact: Michael P. Murphy, Director, Environmental Enhancement, Department of Environmental Quality, P.O. Box 10009, Richmond, VA 23240-0009, telephone (804) 698-4003, FAX (804) 698-4319, (804) 698-4021/TTY ☎ or email mpmurphy@deq.state.va.us.

VIRGINIA RESOURCES AUTHORITY

† **October 12, 1998 - 5:30 p.m.** -- Open Meeting
Virginia Resources Authority, Mutual Building, 909 East Main
Street, Suite 700, Richmond, Virginia.

A meeting of the Personnel Committee to study a proposed employee handbook and determine recommendations to the Board of Directors. Public comments will be received at the beginning of the meeting.

Contact: Robert W. Lauterberg, Executive Director, Virginia Resources Authority, P.O. Box 1300, Richmond, VA 23218, telephone (804) 644-3100 or FAX (804) 644-3109.

October 13, 1998 - 9:30 a.m. -- Open Meeting
Virginia Resources Authority, Mutual Building, 909 East Main
Street, Suite 700, Richmond, Virginia.

A meeting to approve minutes of the prior meeting, to review the authority's operations for the prior month, and to consider other matters and take other actions as the authority may deem appropriate. The planned agenda of the meeting will be available at the offices of the authority one week prior to the date of the meeting. Public comments will be received at the beginning of the meeting.

Contact: Shockley D. Gardner, Jr., Executive Director, Virginia Resources Authority, P.O. Box 1300, Richmond, VA 23218, telephone (804) 644-3100 or FAX (804) 644-3109.

November 10, 1998 - 9:30 a.m. -- Open Meeting

December 8, 1998 - 9:30 a.m. -- Open Meeting
Virginia Resources Authority, Mutual Building, 909 East Main
Street, Suite 700, Richmond, Virginia.

A meeting to approve minutes of the prior meeting, to review the authority's operations for the prior month, and to consider other matters and take other actions as the authority may deem appropriate. The planned agenda of the meeting will be available at the offices of the authority one week prior to the date of the meeting. Public comments will be received at the beginning of the meeting.

Contact: Robert W. Lauterberg, Executive Director, Virginia Resources Authority, P.O. Box 1300, Richmond, VA 23218, telephone (804) 644-3100 or FAX (804) 644-3109.

VIRGINIA SMALL BUSINESS FINANCING AUTHORITY

† **October 27, 1998 - 10 a.m.** -- Open Meeting
Department of Business Assistance, 707 East Main Street,
3rd Floor, Main Board Room, Richmond, Virginia. 🗺

A meeting of the Loan Committee to review applications for loans submitted to the authority for approval. The time will be moved to 8:30 a.m. if the VSBFA Board of Directors decides to combine meeting dates with the VSBFA Loan Committee.

Contact: Cathleen M. Surface, Executive Director, Virginia Small Business Financing Authority, 707 E. Main St., 3rd Floor, Richmond, VA 23219, telephone (804) 371-8254 or FAX (804) 225-3384.

STATE BOARD OF SOCIAL SERVICES

October 16, 1998 - Public comments may be submitted until this date.

Notice is hereby given in accordance with § 9-6.14:7.1 of the Code of Virginia that the State Board of Social Services intends to repeal regulations entitled: **22 VAC 40-40-10 et seq. Rules of the Neighborhood**

Calendar of Events

Assistance Act. The purpose of the proposed action is to repeal outdated and burdensome regulations. New regulations are being promulgated.

Statutory Authority: §§ 63.1-25 and 63.1-323 of the Code of Virginia.

Contact: Phyllis Parrish, Special Projects Coordinator, Department of Social Services, 730 E. Broad St., Richmond, VA 23219, telephone (804) 692-1895 or FAX (804) 692-1869.

October 16, 1998 - Public comments may be submitted until this date.

Notice is hereby given in accordance with § 9-6.14:7.1 of the Code of Virginia that the Board of Social Services intends to adopt regulations entitled: **22 VAC 40-41-10 et seq. Neighborhood Assistance Tax Credit Program.** The purpose of the regulation action is to replace regulations which are being repealed and reflect changes which have developed over time and through legislation. The regulations will set out criteria for approving projects, allocating tax credits and appealing decisions made by Department of Social Services staff. The regulations will also require applicant organizations to submit an audit as a prerequisite to approval.

Statutory Authority: §§ 63.1-25 and 63.1-323 of the Code of Virginia.

Contact: Phyllis Parrish, Special Projects Coordinator, Department of Social Services, 730 E. Broad St., Richmond, VA 23219, telephone (804) 692-1895 or FAX (804) 692-1869.

October 16, 1998 - Public comments may be submitted until this date.

Notice is hereby given in accordance with § 9-6.14:7.1 of the Code of Virginia that the State Board of Social Services intends to repeal regulations entitled: **22 VAC 40-140-10 et seq. Minimum Standards for Independent Foster Homes.** The purpose of the proposed action is to repeal the current standards, which were promulgated in 1949. Concurrently with this action, new standards are being promulgated.

Statutory Authority: §§ 63.1-25 and 63.1-202 of the Code of Virginia.

Contact: Doris Jenkins, Child-Placing/Residential Licensing Manager, Department of Social Services, 730 E. Broad St., Richmond, VA 23219, telephone (804) 692-1773 or FAX (804) 692-2370.

October 16, 1998 - Public comments may be submitted until this date.

Notice is hereby given in accordance with § 9-6.14:7.1 of the Code of Virginia that the State Board of Social Services intends to adopt regulations entitled: **22 VAC 40-141-10 et seq. Minimum Standards for Independent Foster Homes.** The proposed regulation establishes minimum standards that independent foster homes must meet in order to be licensed to provide care to children.

Statutory Authority: §§ 63.1-25 and 63.1-202 of the Code of Virginia.

Contact: Doris Jenkins, Child-Placing/Residential Licensing Manager, Department of Social Services, 730 E. Broad St., Richmond, VA 23219, telephone (804) 692-1773 or FAX (804) 692-2370.

† **October 28, 1998 - 9 a.m.** -- Open Meeting
† **October 29, 1998 - 9 a.m.** -- Open Meeting
Department of Social Services, Western Regional Office, 190 Patton Street, Abingdon, Virginia. ♿

A work session and formal business meeting of the board.

Contact: Pat Rengnerth, Administrative Staff Specialist, Department of Social Services, 730 E. Broad St., Richmond, VA 23219, telephone (804) 692-1826, FAX (804) 692-0319, toll-free 1-800-552-3431 or 1-800-552-7096/TTY ♿

BOARD OF SOCIAL WORK

October 23, 1998 - 9 a.m. -- Open Meeting
Department of Health Professions, 6606 West Broad Street, 5th Floor, Conference Room 4, Richmond, Virginia. ♿

A regularly scheduled meeting to conduct business, including adoption of final amendments to the Regulations Governing the Practice of Social Work, 18 VAC 140-20-10 et seq., discussion of results of a survey pertaining to nonclinical social work practice, and committee assignments and meeting dates for 1999. Public comment will be received at the beginning of the meeting.

Contact: Rai Gilmore, Administrative Assistant, Board of Social Work, 6606 W. Broad St., Richmond, VA 23230-1717, telephone (804) 662-9914, FAX (804) 662-9943 or (804) 662-7197/TTY ♿

VIRGINIA COMMERCIAL SPACE FLIGHT AUTHORITY

October 13, 1998 - 10 a.m. -- Open Meeting
Old Dominion University, Webb University Center, Board Room, Norfolk, Virginia. ♿ (Interpreter for the deaf provided upon request)

Quarterly meeting of the governing board of the authority to discuss business of the authority as determined by the chairman.

Contact: Robert G. Templin, Jr., Chairman, Virginia Commercial Space Flight Authority, CIT, 2214 Rock Hill Rd., Suite 600, Herndon, VA 20170, telephone (703) 689-3010 or toll-free (800) 689-3001.

COUNCIL ON TECHNOLOGY SERVICES

October 27, 1998 - 9 a.m. -- Open Meeting
Washington D.C., - location to be announced.

November 24, 1998 - 9 a.m. -- Open Meeting
Location to be announced.

An organizational meeting of the council.

Contact: Jamie Breeden, Administrative Assistant, Department of Information Technology, 110 S. 7th St., 3rd Floor, Richmond, VA 23219, telephone (804) 371-5506, FAX (804) 371-5273 or (804) 371-8076.

COMMONWEALTH TRANSPORTATION BOARD

October 14, 1998 - 2 p.m. -- Open Meeting
Natural Bridge Hotel, Natural Bridge, Virginia.  (Interpreter for the deaf provided upon request)

A monthly meeting to vote on proposals presented regarding bids, permits, additions and deletions to the highway system, and any other matters requiring board approval. Public comment will be received at the outset of the meeting on items on the meeting agenda for which the opportunity for public comment has not been afforded in another forum. Remarks will be limited to five minutes. Large groups are asked to select one individual to speak for the group. The board reserves the right to amend these conditions. Separate committee meetings may be held on call of the chairman. Contact Department of Transportation Public Affairs at (804) 786-2715 for schedule.

Contact: Shirley J. Ybarra, Secretary of Transportation, 1401 E. Broad St., Richmond, VA 23219, telephone (804) 786-6675.

BOARD FOR THE VISUALLY HANDICAPPED

October 14, 1998 - 11 a.m. -- Open Meeting
Jefferson Madison Regional Library, 201 East Market Street, Charlottesville, Virginia.  (Interpreter for the deaf provided upon request)

A regular quarterly meeting to receive information regarding department activities and operations, review expenditures from the board's institutional fund, and discuss other issues raised by board members.

Contact: Katherine C. Proffitt, Executive Secretary Senior, Department for the Visually Handicapped, 397 Azalea Ave., Richmond, VA 23227, telephone (804) 371-3140, toll-free 1-800-622-2155, FAX (804) 371-3351 or (804) 371-3140/TTY 

VIRGINIA VOLUNTARY FORMULARY BOARD

October 22, 1998 - 10:30 a.m. -- Open Meeting
Washington Building, 1100 Bank Street, 2nd Floor Conference Room, Richmond, Virginia.

A meeting to review the public hearing comments and product data for drug products being considered for inclusion in the Virginia Voluntary Formulary.

Contact: James K. Thomson, Director, Bureau of Pharmacy Services, Virginia Voluntary Formulary, James Monroe Bldg., 101 N. 14th St., Room S-45, Richmond, VA 23219, telephone (804) 786-4326.

VIRGINIA WASTE MANAGEMENT BOARD

† **October 26, 1998 - 9 a.m.** -- Open Meeting
† **November 12, 1998 - 9 a.m.** -- Open Meeting
Department of Environmental Quality, 4949-A Cox Road, Glen Allen, Virginia.  (Interpreter for the deaf provided upon request)

A meeting of the Technical Advisory Committee to discuss the development of the proposed Regulation for Transportation of Solid and Medical Wastes on State Waters, 9 VAC 20-170-10 et seq.

Contact: Lily Choi, Environmental Engineer Senior, Department of Environmental Quality, P.O. Box 10009, Richmond, VA 23240, telephone (804) 698-4054 or FAX (804) 698-4032.

BOARD FOR WASTE MANAGEMENT FACILITY OPERATORS

October 26, 1998 - 10:30 a.m. -- Open Meeting
Department of Professional and Occupational Regulation, 3600 West Broad Street, Conference Room 5 West, Richmond, Virginia. 

A meeting to conduct routine board business. A public comment period will be held at the beginning of the meeting.

Contact: David E. Dick, Assistant Director, Department of Professional and Occupational Regulation, 3600 W. Broad St., Richmond, VA 23230-4917, telephone (804) 367-8595, FAX (804) 367-2474 or (804) 367-9753/TTY 

STATE WATER CONTROL BOARD

October 16, 1998 - Public comments may be submitted until 4 p.m. on this date.

Calendar of Events

Notice is hereby given in accordance with § 9-6.14:7.1 of the Code of Virginia that the State Water Control Board intends to repeal regulations entitled: **9 VAC 25-150-10 et seq. Virginia Pollutant Discharge Elimination System (VPDES) General Permit Regulation for Storm Water Discharges Associated with Industrial Activity from Heavy Manufacturing.** This general permit expires on June 30, 1999, and is not going to be reissued. Therefore, the board intends to repeal the regulation. Future discharges of industrial storm water may be authorized under the new general permit, 9 VAC 25-151-10 et seq.

Question and Answer Period: A question and answer period will be held one-half hour prior to the public hearing at the same location. Interested citizens will have an opportunity to ask questions pertaining to the proposal at that time.

Request for Comments: The board is seeking comments from interested persons on the proposed repeal of this general permit regulation, as well as comments regarding the costs and benefits of the proposal or any other alternatives.

Localities Affected: The repeal of this regulation will be applicable statewide and will not affect any one locality disproportionately.

Comparison with Statutory Mandates: The repeal of this general permit regulation does not exceed the specific minimum requirements of any legally binding state or federal mandate.

Statutory Authority: § 62.1-44.15 (10) of the Code of Virginia.

Contact: Richard Ayers, Technical Services Administrator, Department of Environmental Quality, 629 E. Main St., Richmond, VA 23219, telephone (804) 698-4075.

* * * * *

October 16, 1998 - Public comments may be submitted until 4 p.m. on this date.

Notice is hereby given in accordance with § 9-6.14:7.1 of the Code of Virginia that the State Water Control Board intends to adopt regulations entitled: **9 VAC 25-151-10 et seq. General Virginia Pollutant Discharge Elimination System (VPDES) Permit for Discharges of Storm Water Associated with Industrial Activity.** This regulation will authorize point source discharges of storm water runoff from industrial sites. Discharges may be directly to surface waters or through separate storm sewer systems. This general permit will replace industrial storm water general permits, 9 VAC 25-150-10 et seq., 9 VAC 25-160-10 et seq., and 9 VAC 25-170-10 et seq., which expire June 30, 1999.

Question and Answer Period: A question and answer period will be held one-half hour prior to the public hearing at the same location. Interested citizens will have an opportunity to ask questions pertaining to the proposal at that time.

Request for Comments: The board is seeking comments from interested persons on the proposed repeal of this general permit regulation, as well as comments regarding the costs and benefits of the proposal or any other alternatives.

Localities Affected: The regulation will be applicable statewide and will not affect any one locality disproportionately.

Comparison with Statutory Mandates: The repeal of this general permit regulation does not exceed the specific minimum requirements of any legally binding state or federal mandate.

Statutory Authority: § 62.1-44.15 (10) of the Code of Virginia.

Contact: Richard Ayers, Technical Services Administrator, Department of Environmental Quality, 629 E. Main St., Richmond, VA 23219, telephone (804) 698-4075.

* * * * *

October 16, 1998 - Public comments may be submitted until 4 p.m. on this date.

Notice is hereby given in accordance with § 9-6.14:7.1 of the Code of Virginia that the State Water Control Board intends to repeal regulations entitled: **9 VAC 25-160-10 et seq. Virginia Pollutant Discharge Elimination System (VPDES) General Permit Regulation for Storm Water Discharges Associated with Industrial Activity from Light Manufacturing Facilities.** This general permit expires on June 30, 1999, and is not going to be reissued. Therefore, the board intends to repeal the regulation. Future discharges of industrial storm water may be authorized under the new general permit, 9 VAC 25-151-10 et seq.

Question and Answer Period: A question and answer period will be held one-half hour prior to the public hearing at the same location. Interested citizens will have an opportunity to ask questions pertaining to the proposal at that time.

Request for Comments: The board is seeking comments from interested persons on the proposed repeal of this general permit regulation, as well as comments regarding the costs and benefits of the proposal or any other alternatives.

Localities Affected: The repeal of this regulation will be applicable statewide and will not affect any one locality disproportionately.

Comparison with Statutory Mandates: The repeal of this general permit regulation does not exceed the specific minimum requirements of any legally binding state or federal mandate.

Statutory Authority: § 62.1-44.15 (10) of the Code of Virginia.

Contact: Richard Ayers, Technical Services Administrator, Department of Environmental Quality, 629 E. Main St., Richmond, VA 23219, telephone (804) 698-4075.

* * * * *

October 16, 1998 - Public comments may be submitted until 4 p.m. on this date.

Notice is hereby given in accordance with § 9-6.14:7.1 of the Code of Virginia that the State Water Control Board intends to repeal regulations entitled: **9 VAC 25-170-10 et seq. Virginia Pollutant Discharge Elimination System (VPDES) General Permit Regulation for Storm Water Discharges Associated with Industrial Activity from Transportation Facilities, Landfills, Land Application Sites and Open Dumps, Materials Recycling Facilities, and Steam Electric Power Generating Facilities.** This general permit expires on June 30, 1999, and is not going to be reissued. Therefore, the board intends to repeal the regulation. Future discharges of industrial storm water may be authorized under the new general permit, 9 VAC 25-151-10 et seq.

Question and Answer Period: A question and answer period will be held one-half hour prior to the public hearing at the same location. Interested citizens will have an opportunity to ask questions pertaining to the proposal at that time.

Request for Comments: The board is seeking comments from interested persons on the proposed repeal of this general permit regulation, as well as comments regarding the costs and benefits of the proposal or any other alternatives.

Localities Affected: The repeal of this regulation will be applicable statewide and will not affect any one locality disproportionately.

Comparison with Statutory Mandates: The repeal of this general permit regulation does not exceed the specific minimum requirements of any legally binding state or federal mandate.

Statutory Authority: § 62.1-44.15 (10) of the Code of Virginia.

Contact: Richard Ayers, Technical Services Administrator, Department of Environmental Quality, 629 E. Main St., Richmond, VA 23219, telephone (804) 698-4075.

* * * * *

October 16, 1998 - Public comments may be submitted until 4 p.m. on this date.

Notice is hereby given in accordance with § 9-6.14:7.1 of the Code of Virginia that the State Water Control Board intends to amend regulations entitled: **9 VAC 25-180-10 et seq. Virginia Pollutant Discharge Elimination System (VPDES) General Permit**

Regulation for Storm Water Discharges from Construction Sites. This regulation authorizes discharges of storm water runoff from construction activities. The amendment is proposed in order to reissue the general permit for an additional five year term.

Question and Answer Period: A question and answer period will be held one-half hour prior to the public hearing at the same location. Interested citizens will have an opportunity to ask questions pertaining to the proposal at that time.

Request for Comments: The board is seeking comments from interested persons on the proposed repeal of this general permit regulation, as well as comments regarding the costs and benefits of the proposal or any other alternatives.

Localities Affected: The regulation will be applicable statewide and will not affect any one locality disproportionately.

Comparison with Statutory Mandates: The repeal of this general permit regulation does not exceed the specific minimum requirements of any legally binding state or federal mandate.

Statutory Authority: § 62.1-44.15 (10) of the Code of Virginia.

Contact: Richard Ayers, Technical Services Administrator, Department of Environmental Quality, 629 E. Main St., Richmond, VA 23219, telephone (804) 698-4075.

† October 22, 1998 - 9 a.m. -- Open Meeting
Department of Environmental Quality, 629 East Main Street, Richmond, Virginia.  (Interpreter for the deaf provided upon request)

A meeting to obtain input of interested persons regarding the development of proposed regulations for aboveground storage tank (AST) and pipeline financial responsibility.

Contact: Mary-Ellen Kendall, Financial Programs Manager, Department of Environmental Quality, 629 E. Main St., 7th Floor, Richmond, VA 23219, telephone (804) 698-4499, FAX (804) 698-4266, toll-free 1-800-592-5482 or (804) 698-4021/TTY 

BOARD FOR WATERWORKS AND WASTEWATER WORKS OPERATORS

October 29, 1998 - 8:30 a.m. -- Open Meeting
Department of Professional and Occupational Regulation, 3600 West Broad Street, Conference Room 5W, Richmond, Virginia. 

A routine business meeting. A public comment period will be held at the beginning of the meeting.

Contact: David E. Dick, Assistant Director, Department of Professional and Occupational Regulation, 3600 W. Broad

Calendar of Events

St., Richmond, VA, telephone (804) 367-8505, FAX (804) 367-2475 or (804) 367-9753/TTY ☎

GOVERNOR'S ADVISORY COMMISSION ON WELFARE REFORM

October 13, 1998 - 10 a.m. -- Open Meeting
Department of Social Services, Theater Row Building, 730 East Broad Street, Lower Level 2, Richmond, Virginia. ♿

A meeting to provide an update on the progress of welfare reform.

Contact: Fay G. Lohr, Director, Division of Community Programs and Resources, Department of Social Services, 730 E. Broad St., Richmond, VA 23219, telephone (804) 692-1895 or FAX (804) 692-1869.

INDEPENDENT

STATE LOTTERY BOARD

October 14, 1998 - 9:30 a.m. -- Open Meeting
State Lottery Department, 900 East Main Street, Richmond, Virginia. ♿ (Interpreter for the deaf provided upon request)

A regular meeting of the board. Public comment will be received at the beginning of the meeting. This meeting replaces the September 23rd meeting, which was canceled.

Contact: Barbara L. Robertson, Board, Legislative and Regulatory Coordinator, State Lottery Department, 900 E. Main St., Richmond, VA 23219, telephone (804) 692-7105 or FAX (804) 692-7603.

LEGISLATIVE

ADMINISTRATIVE LAW ADVISORY COMMITTEE

October 21, 1998 - 11 a.m. -- Open Meeting
State Capitol, Capitol Square, House Room 1, Richmond, Virginia. ♿ (Interpreter for the deaf provided upon request)

A meeting to receive the study committee reports and to begin planning for the spring conference.

Contact: Lyn Coughlin, Program Coordinator, Administrative Law Advisory Committee, General Assembly Bldg., 910 Capitol St., 2nd Floor, Richmond, VA 23219, telephone (804) 786-3591 or FAX (804) 692-0625.

SPECIAL JOINT SUBCOMMITTEE OF THE SENATE COMMITTEE ON EDUCATION AND HEALTH AND THE HOUSE COMMITTEE ON HEALTH, WELFARE AND INSTITUTIONS TO STUDY THE CERTIFICATE OF PUBLIC NEED

November 12, 1998 - 10 a.m. -- Open Meeting
General Assembly Building, 9th and Broad Streets, Senate Room B, Richmond, Virginia. ♿ (Interpreter for the deaf provided upon request)

A regular meeting. Individuals requiring interpreter services or other accommodations should call or write Senate committee operations at least 10 working days prior to the meeting.

Contact: Brian B. Taylor, Senate Committee Operations, P.O. Box 396, Richmond, VA 23218, telephone (804) 698-7450 or (804) 698-7419/TTY ☎

COMMISSION ON THE CONDITION AND FUTURE OF VIRGINIA'S CITIES (HJR 432, 1998)

October 13, 1998 - 10 a.m. -- Open Meeting
Omni Hotel, Charlottesville, Virginia.

A regular meeting. Questions regarding the meeting should be addressed to Jeff Sharp or Nikki Rovner, Division of Legislative Services, (804) 786-3591. Individuals requiring interpreter services or other special assistance should contact the Committee Operations Office at least 10 working days prior to the meeting.

Contact: Barbara Regen, House Committee Operations, P.O. Box 406, Richmond, VA 23218, telephone (804) 698-1540 or (804) 786-2369/TTY ☎

October 20, 1998 - 2 p.m.—Open Meeting
State Capitol, Capitol Square, House Room 1, Richmond, Virginia. ♿

A meeting of subcommittee #4.

Contact: Barbara Regen, House Committee Operations, P.O. Box 406, Richmond, VA 23218, telephone (804) 698-1540 or (804) 786-2369/TTY ☎

VIRGINIA CODE COMMISSION

November 18, 1998 - 10 a.m. -- Open Meeting
General Assembly Building, 9th and Broad Streets, Speaker's Conference Room, 6th Floor, Richmond, Virginia. ♿ (Interpreter for the deaf provided upon request)

A meeting to continue with the recodification of Titles 2.1 and 9 of the Code of Virginia and to conduct any other business of the commission.

Contact: Jane Chaffin, Registrar of Regulations, General Assembly Bldg., 9th and Broad Streets, 2nd Floor, Richmond, VA 23219, telephone (804) 786-3591, FAX (804) 692-0625 or e-mail jchaffin@leg.state.va.us.

HOUSE CORPORATIONS, INSURANCE AND BANKING COMMITTEE

† **October 22, 1998 - 9:30 a.m.** -- Open Meeting
State Capitol, Capitol Square, House Room 1, Richmond, Virginia.  (Interpreter for the deaf provided upon request)

A meeting of Subcommittee #4 to consider carry-over legislation. Questions regarding the meeting should be addressed to Rob Omberg, Division of Legislative Services, (804) 786-3591. Individuals requiring interpreter services or other special assistance should contact the committee operations office at least 10 working days prior to the meeting.

Contact: Barbara Regen, House Committee Operations, P.O. Box 406, Richmond, VA 23218, telephone (804) 698-1540 or (804) 786-2369/TTY 

HOUSE COURTS OF JUSTICE SUBCOMMITTEE

† **November 16, 1998 - Noon** -- Open Meeting
General Assembly Building, 9th and Broad Streets, House Room C, Richmond, Virginia.  (Interpreter for the deaf provided upon request)

A meeting of the Special House Courts of Justice Subcommittee Studying HJR 194 (State Employment); HJR 218 (Disclosure—Autopsy and Medical Exam Records); and HJR 246 (Church Trustees). Questions regarding the meeting should be addressed to Carey Friedman, Courts Counsel, Division of Legislative Services, (804) 786-3591. Individuals requiring interpreter services or other special assistance should contact Anne Howard at least 10 working days prior to the meeting.

Contact: Anne R. Howard, House Committee Operations, P.O. Box 406, Richmond, VA 23218, telephone (804) 698-1540 or (804) 786-2369/TTY 

COMMISSION ON EDUCATIONAL INFRASTRUCTURE (HJR 165)

October 28, 1998 - 10 a.m. -- Open Meeting
November 23, 1998 - 2 p.m. -- Open Meeting
General Assembly Building, 9th and Broad Streets, House Room D, Richmond, Virginia.  (Interpreter for the deaf provided upon request)

A regular meeting. Questions regarding the meeting should be addressed to Norma Szakal, Division of Legislative Services, (804) 786-3591. Individuals requiring interpreter services or other special assistance should contact the committee operations office at least 10 working days prior to the meeting.

Contact: Lois V. Johnson, House Committee Operations, P.O. Box 406, Richmond, VA 23218, telephone (804) 698-1540 or (804) 786-2369/TTY 

SUBCOMMITTEE STUDYING THE FUTURE OF VIRGINIA'S ENVIRONMENT (HJR 136)

October 29, 1998 - 10 a.m. -- Open Meeting
December 17, 1998 - 10 a.m. -- Open Meeting
General Assembly Building, 9th and Broad Streets, House Room D, Richmond, Virginia.  (Interpreter for the deaf provided upon request)

A regular meeting. Please direct all questions regarding the agenda to Shannon Varner, Division of Legislative Services, at (804) 786-3591. Individuals requiring interpreter services or other accommodations should contact the committee operations office at least 10 working days prior to the meeting.

Contact: Lois V. Johnson, Committee Operations, House of Delegates, State Capitol, P.O. Box 406, Richmond, VA 23218, telephone (804) 698-1540 or (804) 786-2369/TTY 

HOUSE COMMITTEE ON FINANCE

Business Tax Incentives Subcommittee

† **October 29, 1998 - 10 a.m.** -- Open Meeting
General Assembly Building, 9th and Broad Streets, 4th Floor West Conference Room, Richmond, Virginia.  (Interpreter for the deaf provided upon request)

A regular meeting. Questions regarding the meeting should be addressed to Joan E. Putney or Stephanie L. Hamlett, Division of Legislative Services, (804) 786-3591. Individuals requiring interpreter services or other special assistance should contact Lois Johnson at least 10 working days prior to the meeting.

Contact: Lois V. Johnson, House Committee Operations, P.O. Box 406, Richmond, VA 23218, telephone (804) 698-1540 or (804) 786-2369/TTY 

Property Tax Subcommittee

† **October 26, 1998 - 10:30 a.m.** -- Open Meeting
General Assembly Building, 9th and Broad Streets, 4th Floor West Conference Room, Richmond, Virginia.  (Interpreter for the deaf provided upon request)

A regular meeting. Questions regarding the meeting should be addressed to Joan E. Putney or Stephanie L. Hamlett, Division of Legislative Services, (804) 786-3591. Individuals requiring interpreter services or other special assistance should contact Lois Johnson at least 10 working days prior to the meeting.

Contact: Lois V. Johnson, House Committee Operations, P.O. Box 406, Richmond, VA 23218, telephone (804) 698-1540 or (804) 786-2369/TTY 

Calendar of Events

JOINT SUBCOMMITTEE STUDYING THE VIRGINIA FREEDOM OF INFORMATION ACT (HJR 187)

October 14, 1998 - 10 a.m. -- Open Meeting

November 4, 1998 - 9 a.m. -- Open Meeting

General Assembly Building, 9th and Broad Streets, House Room C, Richmond, Virginia.  (Interpreter for the deaf provided upon request)

A regular meeting. Questions regarding the meeting should be addressed to Maria J.K. Everett, Senior Attorney, Division of Legislative Services, (804) 786-3591. Individuals requiring interpreter services or other special assistance should contact the committee operations office at least 10 working days prior to the meeting. (The website for this study is <http://dls.state.va.us/hjr187.htm>.)

Contact: Anne R. Howard, House Committee Operations, P.O. Box 406, Richmond, VA 23218, telephone (804) 698-1540 or (804) 786-2369/TTY 

HOUSE COMMITTEE ON GENERAL LAWS

Subcommittee 6

October 27, 1998 - 10 a.m. -- Open Meeting

General Assembly Building, 9th and Broad Streets, House Room C, Richmond, Virginia.  (Interpreter for the deaf provided upon request)

A meeting to consider the following resolutions: HJR 181 Study - Motion Picture Production Industry and HJR 260 Study - Waste Tires. Questions regarding the meeting agenda should be addressed to Maria Everett, Division of Legislative Services, (804) 786-3591. Individuals requiring interpreter services or other special assistance should contact the committee operations office at least 10 working days prior to the meeting.

Contact: Lois V. Johnson, House Committee Operations, P.O. Box 406, Richmond, VA 23218, telephone (804) 698-1540 or (804) 786-2369/TTY 

JOINT COMMISSION ON HEALTH CARE

October 20, 1998 - 10 a.m. -- Open Meeting

November 17, 1998 - 10 a.m. -- Open Meeting

General Assembly Building, 9th and Broad Streets, Senate Room A, Richmond, Virginia.  (Interpreter for the deaf provided upon request)

A regular meeting. Individuals requiring interpreter services or other special assistance should contact Kathleen Myers at least 10 working days prior to the meeting.

Contact: Kathleen Myers, Committee Operations, House of Delegates, State Capitol, P.O. Box 406, Richmond, VA 23218, telephone (804) 698-1547 or (804) 786-2369/TTY 

COMMISSION ON ACCESS AND DIVERSITY IN HIGHER EDUCATION IN VIRGINIA (HJR 226/1998)

October 23, 1998 - 10 a.m. -- Open Meeting

General Assembly Building, 9th and Broad Streets, House Room C, Richmond, Virginia.  (Interpreter for the deaf provided upon request)

November 18, 1998 - 10 a.m. -- Open Meeting

General Assembly Building, 9th and Broad Streets, House Room C, Richmond, Virginia.  (Interpreter for the deaf provided upon request)

A regular meeting. Questions regarding the meeting should contact Brenda Edwards, Division of Legislative Services, (804) 786-3591. Individuals requiring interpreter services or other special assistance should contact Dawn Smith at least 10 working days prior to the meeting.

Contact: Dawn B. Smith, Committee Operations, House of Delegates, State Capitol, P.O. Box 406, Richmond, VA 23218, telephone (804) 698-1540 or (804) 786-2369/TTY 

JOINT LEGISLATIVE AUDIT AND REVIEW COMMISSION

† **October 13, 1998 - 10 a.m.** -- Open Meeting

General Assembly Building, 910 Capitol Square, Senate Room A, Richmond, Virginia. 

Staff briefings on the VDOT use of consultants and the HJR 137 Health and Human Resources Interim Review of the Department for the Aging.

Contact: Phillip A. Leone, Director, Joint Legislative Audit and Review Commission, General Assembly Building, 910 Capitol St., Suite 1100, Richmond, VA 23219, telephone (804) 786-1258.

JOINT SUBCOMMITTEE STUDYING MEDICAID REIMBURSEMENT BILLING PROGRAM FOR PUBLIC SCHOOLS (SJR 182/1998)

† **November 10, 1998 - 1:30 p.m.** -- Open Meeting

† **December 18, 1998 - 1 p.m.** -- Open Meeting

General Assembly Building, 9th and Broad Streets, Senate Room B, Richmond, Virginia.  (Interpreter for the deaf provided upon request)

A regular meeting. Individuals requiring interpreter services or other accommodations should call or write Senate Committee Operations at least 10 working days prior to the meeting.

Contact: Patty Lung, Senate Committee Operations, P.O. Box 396, Richmond, VA 23218, telephone (804) 698-7450 or (804) 698-7419/TTY 

JOINT SUBCOMMITTEE STUDYING THE FUTURE DELIVERY OF PUBLICLY FUNDED MENTAL HEALTH, MENTAL RETARDATION AND SUBSTANCE ABUSE SERVICES (HJR 225)

October 27, 1998 - 10 a.m. -- Open Meeting
General Assembly Building, 9th and Broad Streets, House Room D, Richmond, Virginia. ♿ (Interpreter for the deaf provided upon request)

December 16, 1998 - 10 a.m. -- Open Meeting
General Assembly Building, 9th and Broad Streets, House Room C, Richmond, Virginia. ♿ (Interpreter for the deaf provided upon request)

A regular meeting. Individuals requiring interpreter services or other special assistance should contact Dawn Smith at least 10 working days prior to the meeting.

Contact: Dawn B. Smith, Committee Operations, House of Delegates, State Capitol, P.O. Box 406, Richmond, VA 23218, telephone (804) 698-1540 or (804) 786-2369/TTY ☎

CHRONOLOGICAL LIST

OPEN MEETINGS

October 12

† Resources Authority, Virginia
- Personnel Committee

October 13

Chesapeake Bay Local Assistance Board
- Northern Area Review Committee
- Southern Area Review Committee
Cities, Commission on the Condition and Future of Virginia's
Commercial Space Flight Authority, Virginia
† Community Colleges, State Board for
† Legislative Audit and Review Commission, Joint
Medical Assistance Services, Board of
Nursing, Board of
- Special Conference Committee
† Outdoors Foundation, Virginia
- Trust Fund Advisory Board
Resources Authority, Virginia
Welfare Reform, Governor's Advisory Commission on

October 14

Agriculture and Consumer Services, Department of
- Virginia Marine Products Board
† Contractors, Board for
Freedom of Information Act, Joint Subcommittee
Studying the Virginia
† Gangs and Youth Violence, Task Force on
Juvenile Justice, Board of
Lottery Board, State
Motor Vehicles, Department of

- Medical Advisory Board
† Outdoors Foundation, Virginia
- Open Space Lands Preservation Fund Advisory Board
Transportation Board, Commonwealth
Visually Handicapped, Board for the

October 15

Information Management, Council
- Virginia Geographic Information Network Advisory Board
Nursing, Board of
- Special Conference Committee

October 16

Dentistry, Board
- Special Conference Committee
† Housing and Community Development, Department of
- State Building Code Technical Review Board

October 18

Fire Services Board, Virginia
- Legislative/Liaison Committee

October 19

Accountancy, Board for
Alcoholic Beverage Control Board
Conservation and Recreation, Board of
Funeral Directors and Embalmers, Board of
Labor and Industry, Department of
- Safety and Health Codes Board

October 20

† Charitable Gaming Commission
Cities, Commission on the Condition and Future of Virginia's
Health Care, Joint Commission on
Higher Education for Virginia, State Council of
† Housing Development Authority
- Board of Commissioners
Manufactured Housing Board, Virginia
† Nursing, Board of
Pharmacy, Board of

October 21

Administrative Law Advisory Committee
† Geology, Board for
George Mason University
- Board of Visitors
† Medicine, Board of
- Informal Conference Committee
† Nursing, Board of
- Special Conference Committee
Racing Commission, Virginia

October 22

† Corporations, Insurance and Banking Committee,
House
- Subcommittee 4
Game and Inland Fisheries, Board of
† Job Training Coordinating Council, Governor's
† Nursing, Board of
- Special Conference Committee

Calendar of Events

† Real Estate Board
- Common Interest Community Management Information Fund Advisory Committee
Voluntary Formulary Board, Virginia
† Water Control Board, State

October 23

Game and Inland Fisheries, Board of
Higher Education in Virginia, Commission on Access and Diversity in
Social Work, Board of

October 24

Conservation and Recreation, Department of
- Virginia Cave Board

October 26

† Finance, House Committee on
- Property Tax Subcommittee
† Gangs and Violence, Task Force on
Information Management, Council on
- Lands Records Management Task Force
Nursing Home Administrators, Board of
- Special Conference Committee
† Waste Management Board, Virginia
- Technical Advisory Committee
Waste Management Facility Operators, Board for

October 27

† Aviation Board, Virginia
† Conservation and Recreation, Department of
- Master Plan Development for First Landing/Seashore State Park
- Board on Conservation and Development of Public Beaches
General Laws, House Committee on
- Subcommittee 6
† Local Government, Commission on
† Marine Resources Commission
Nursing Home Administrators, Board of
Professional Counselors, Marriage and Family Therapists and Substance Abuse Treatment Professionals, Board of Licensed
Publicly Funded Mental Health, Mental Retardation and Substance Abuse Services, Joint Subcommittee
Evaluating the Future Delivery of (HJR 225)
Real Estate Appraiser Board
† Small Business Financing Authority, Virginia
- Loan Committee
Technology Services, Council on

October 28

† Aviation Board, Virginia
† Branch Pilots, Board for
Educational Infrastructure, Commission on
Funeral Directors and Embalmers, Board of
† Maternal and Child Health Council
Pharmacy, Board of
† Recycling Markets Development Council, Virginia
- Ad Hoc Subcommittee
† Social Services, State Board of

October 29

† Arts, Virginia Commission for the
- Advisory Panel for Artist Roster
Audiology and Speech-Language Pathology, Board of
- Advisory Committee on Support Personnel
† Branch Pilots, Board for
Compensation Board
Environment, Subcommittee Studying the Future of Virginia's
† Finance, House Committee on
- Business Tax Incentives
Funeral Directors and Embalmers, Board of
† Higher Education Tuition Trust Fund, Virginia
† Litter Control and Recycling Fund Advisory Board
† Nursing, Board of
- Special Conference Committee
Waterworks and Wastewater Works Operators, Board for

October 30

At-Risk Youth and Their Families, Comprehensive Services for
- State Executive Council
Dentistry, Board of
Executive Council, State

November 3

Hopewell Industrial Safety Council
Museum of Fine Arts, Virginia
- Executive Committee

November 4

Deaf and Hard-of-Hearing, Virginia Department for the Freedom of Information Act, Joint Subcommittee Studying the Virginia
† Funeral Directors and Embalmers, Board of
- Task Force Committee on Resident Trainee Program

November 5

† Emergency Planning Committee, Local - Chesterfield County
† Medicine, Board of
- Informal Conference Committee

November 7

† Museum of Natural History, Virginia
- Board of Trustees

November 9

† Arts, Virginia Commission for the Arts
- Advisory Panel for Fiction Fellowships

November 10

Asbestos and Lead, Board for
† Medicaid Reimbursement Billing Program for Public Schools, Joint Subcommittee Studying
Resources Authority, Virginia

November 12

† Certificate of Public Need, Special Joint Subcommittee to Study the

- † Professional Counselors, Marriage and Family Therapists and Substance Abuse Treatment Professionals, Board of Licensed
- † Waste Management Board, Virginia
 - Technical Advisory Committee

November 13

- † Health Professions, Department of
 - Health Practitioner's Intervention Program
- † Opticians, Board for
- † Professional Counselors, Marriage and Family Therapists and Substance Abuse Treatment Professionals, Board of Licensed

November 16

- † House Courts of Justice
 - Subcommittee Studying HJR 194 (State Employment); HJR 218 (Disclosure—Autopsy and Medical Exam Records); and HJR 246 (Church Trustees)
- † Local Government, Commission on Professional and Occupational Regulation, Board for

November 17

- † Funeral Directors and Embalmers, Board of
 - Legislative Committee
- Health Care, Joint Commission on Higher Education for Virginia, State Council of

November 18

- Code Commission, Virginia
- Higher Education in Virginia, Commission on Access and Diversity in
- Racing Commission, Virginia

November 19

- † Museum of Fine Arts, Virginia
 - Exhibitions Committee
 - Planning Committee

November 20

- † At-Risk Youth and Their Families, Comprehensive Services for
 - Executive Council, State

November 23

- Educational Infrastructure, Commission on
- † Marine Resources Commission

November 24

- Technology Services, Council on

November 25

- † Compensation Board

December 2

- † Arts, Virginia Commission for the

December 3

- † Emergency Planning Committee, Local - Chesterfield County

December 8

- Resources Authority, Virginia

December 10

- † Outdoors Foundation, Virginia
 - Board of Trustees

December 16

- Publicly Funded Mental Health, Mental Retardation and Substance Abuse Services, Joint Subcommittee
- Evaluating the Future Delivery of (HJR 225)

December 17

- Environment, Subcommittee Studying the Future of Virginia's

December 18

- † Medicaid Reimbursement Billing Program for Public Schools, Joint Subcommittee Studying

December 21

- † Marine Resources Commission

December 23

- † Compensation Board

PUBLIC HEARINGS

October 14

- Pharmacy, Board of

October 15

- Pesticide Control Board

October 20

- Labor and Industry, Department of

October 27

- † Local Government, Commission on Mental Health, Mental Retardation and Substance Abuse Services, State Board of

October 28

- Air Pollution Control Board, State
- Mental Health, Mental Retardation and Substance Abuse Services, State Board of

October 29

- Branch Pilots, Board for
- Mental Health, Mental Retardation and Substance Abuse Services, State Board of

October 30

- Mental Health, Mental Retardation and Substance Abuse Services, State Board of

November 6

- Optometry, Board of

November 18

- † Medicine, Board of
 - Advisory Board on Physical Therapy
- † Racing Commission, Virginia
